

Historic, Archive Document

Do not assume content reflects current scientific knowledge, policies, or practices.



PLATT'S SEEDS

1932

Vegetable Seed Trials

LIBRARY
RECEIVED
FEB 10 1932
U. S. Department of Agriculture

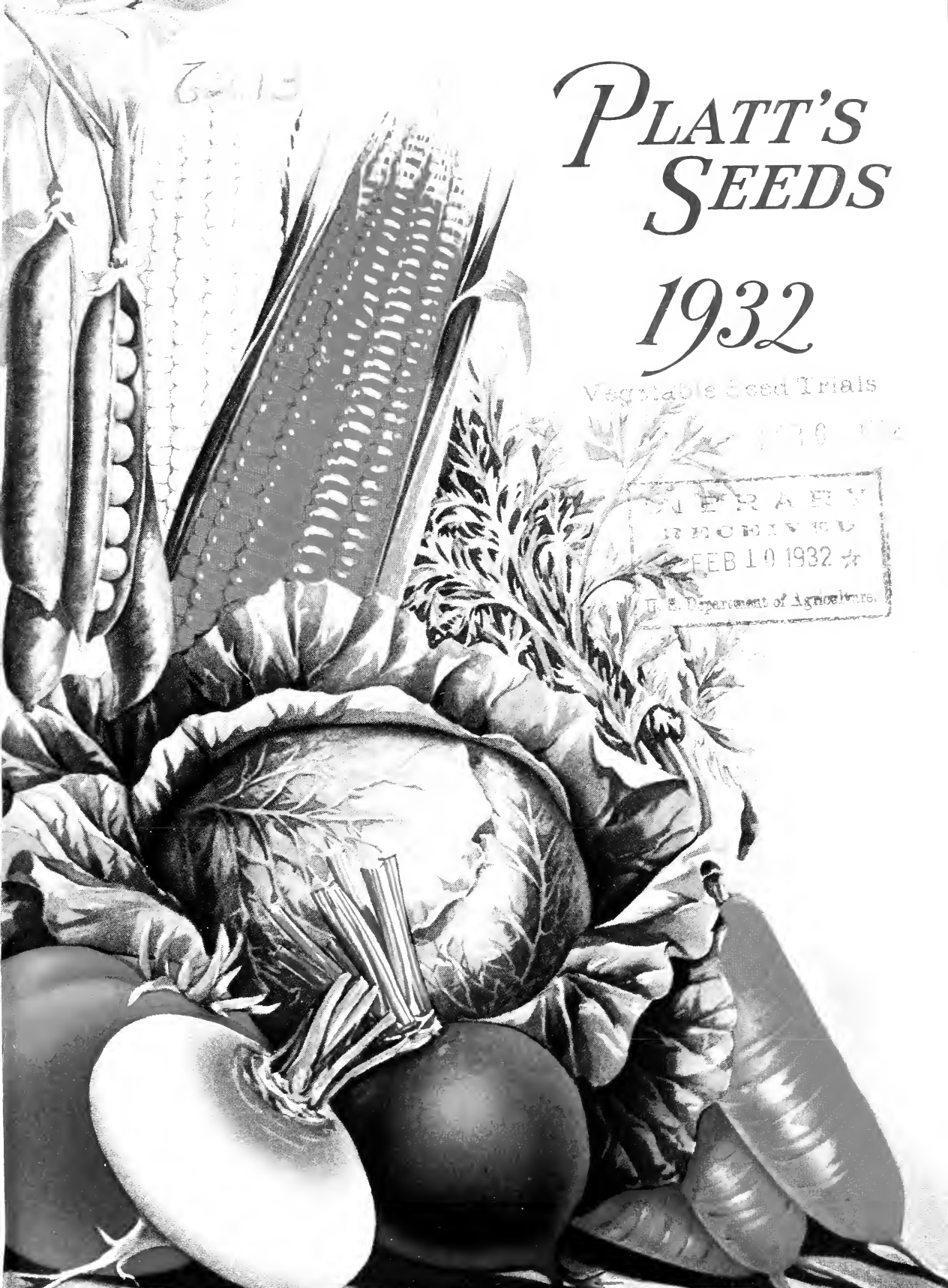

THE FRANK S. PLATT CO.
SEEDSMEN • • • NEW HAVEN • CONN.

BLAIR MOWERS

A New England Quality Product

THE EXPERIENCED buyer will recognize workmanship and specifications in these lawn mowers which assure a long and useful life of satisfaction. Fafnir Ground Race Ball Bearings, Timken Tapered and Hyatt Roller Bearings are used, together with finest materials and the exclusive Drawcut features, which mean true economy. Back of these machines stands a reputation of more than fifty years for making good mowers at fair prices.

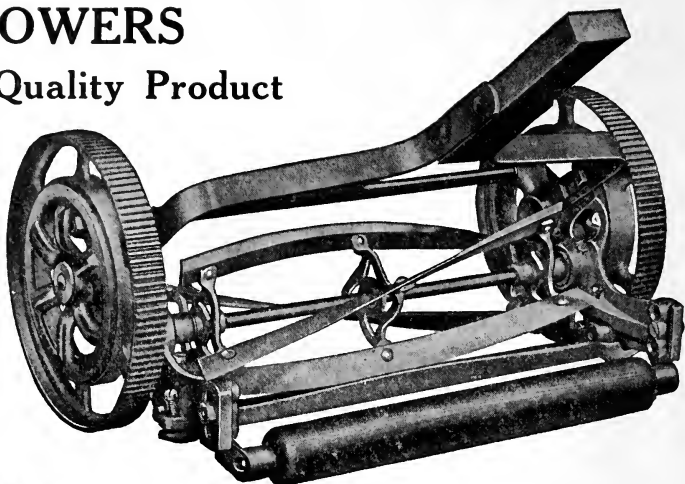

THE AUTOMATIC 11/5 is equipped with Fafnir Ground Race Bearings, automatically adjusted; skeleton frame and wheels; eleven-inch traction wheels; five drawcut wiper blades; malleable iron cutter heads and gear case covers; Sheffield steel, lipped edge stationary knife, automatically sharpened; truss knife bar, strong and rigid; mould-fitted adjusting screws, will not loosen; malleable iron roller brackets, will not break. A high-grade light-running lawn mower. Price, 18-inch cut, \$13.25.

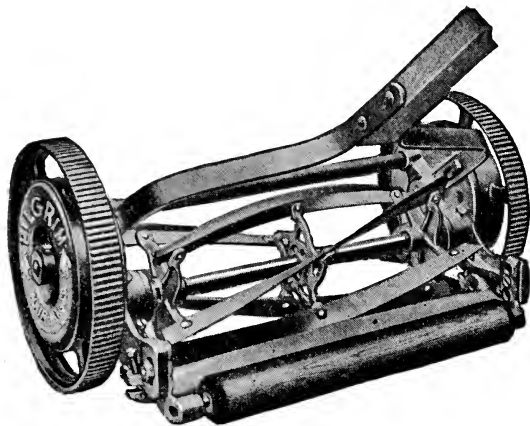

THE PILGRIM

THE PILGRIM, for sturdy, smooth operation, has Timken tapered roller bearing blade cylinder; eleven-inch traction wheels; five crucible steel drawcut wiper blades; Sheffield steel lipped edge stationary knife, automatically sharpened; dust-proof oil cups; truss knife bar; malleable iron roller brackets and cutter heads. Interchangeable parts throughout; easy to keep in adjustment. Prices: The Pilgrim, 18-inch cut, \$17.00; 20-inch cut, \$18.50.

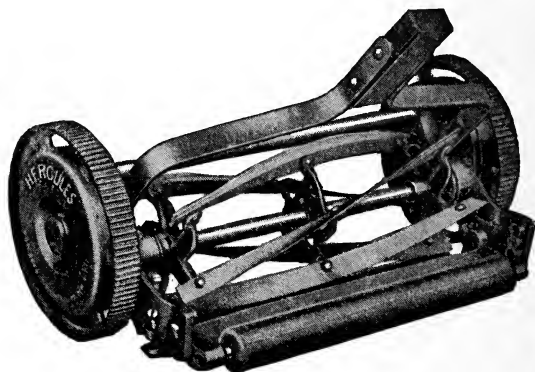

THE HERCULES

HERCULES. The Mower De Luxe. Hyatt roller bearing traction wheels; steel wheel shafts; Timken roller bearing blade cylinder; dust-proof oil cups; nine-inch traction wheels; five crucible steel drawcut wiper blades; Sheffield steel, lipped edge stationary knife, automatically sharpened; truss knife bar; malleable iron roller brackets and cutter heads. Recommended particularly for parks, cemeteries and estates. Prices: Hercules, 18-inch cut, \$21.50; 20-inch cut, \$23.00.

SEE OUR STYLE E AND OTHER MOWERS SHOWN ON PAGE 73

Style E, 18-inch.....\$13.25
Automatic 9/4, 16-inch..... 7.75
Yankee Special, 14-inch..... 5.25

Moto-Mower

A Real Grass Cutter

The Moto-Mower has overcome the problem of cutting grass with a power mower on hills, terraces, around shrubbery, flower beds and in the nooks and corners. And don't forget, the Moto-Mower will do a big day's cutting on the open lawn. Send for catalogue of full information.

Detroit Model—Cuts 27-inches wide, Climbs 35% grade. Two horsepower. Cutting capacity, 4 to 5 acres. Motor, 4-cycle..... Price, \$280.00
City Model—One horsepower, 21-inch cut..... Price, \$188.00

LAWN ROLLERS. See page 80



The Frank S. Platt Co.

Established 1877

1877



1932

Platt's Seeds for 1932

IT is a fact that there is often little or no visible indication of important differences in the many features which go to make some seeds more desirable than others. The characteristics of high yield, uniformity, earliness, size, shape, color and other desirable features cannot be maintained except at great expense of time and skill.

In the production of Platt's Seeds, each kind or small group of kinds are in the hands of men capable of giving expert attention to scientific crossing and selection necessary to maintain strains of real merit up to the highest possible standard of perfection. The crops are critically rogued, cleaned, prepared and handled with all possible care. How well we have succeeded is best evidenced by more than fifty years of serving a critical trade.

We wish here to express our appreciation for the confidence shown and respectfully solicit your further orders.

We Make a Specialty of GRASS SEED for Lawns and Athletic Fields, Including
Evergreen Lawn, Edgewood Park Lawn, Fine Lawn, Shady Lawn
ALSO FOR HAY AND PASTURE

OUR POULTRY SUPPLIES

We are printing the annual list in conjunction with the Seed Catalogue, and pages 81 to 90 offer a comprehensive introductory to this special feature.

The name "PLATCO" applied to our special formulae represents the superlative. In feed it signifies purity, sound, clean, sweet grain. We do not employ adulterants or by-products, screenings, salvaged stock, or musty and damaged matter. QUALITY and the BEST spells it another way.

SPECIAL NOTICE TO MARKET GARDENERS

We sell to Market Gardeners, Truckers and Farmers' Clubs, buying in large quantities and solicit their inquiries for close prices on round lots.

SEEDS, ETC., BY PARCEL POST

The prices in this catalogue do not include postage, except on vegetable and flower seeds by the packet, ounce or quarter-pound and single pound. Larger amounts according to zone rates (see table below). When allowing for postage make allowance for packing, as one pound packed ready to mail weighs more than one pound and counts as two pounds according to postal rules, which state "a fraction of a pound being computed as a full pound." Poisons cannot be sent by mail.

| Parcel Post Zone Rates Within the United States | First Pound or Fraction | Each Additional Pound or Fraction. |
|---|-------------------------|------------------------------------|
| First Zone, up to 50 miles from New Haven..... | \$0.07 | \$0.01 |
| Second Zone, up to 150 miles from New Haven..... | .07 | .01 |
| Third Zone, up to 300 miles from New Haven..... | .08 | .02 |
| Fourth Zone, up to 600 miles from New Haven..... | .09 | .04 |
| Fifth Zone, up to 1,000 miles from New Haven..... | .10 | .06 |
| Sixth Zone, up to 1,400 miles from New Haven..... | .11 | .08 |
| Seventh Zone, up to 1,800 miles from New Haven..... | .13 | .10 |
| Eighth Zone, all over 1,800 miles from New Haven..... | .14 | .12 |

EXPRESS SHIPMENTS

There is a special express rate on seeds of 25 per cent less than the regular rates. Express is more desirable in most cases for packages weighing 20 pounds or more, according to local conditions. Liquids and poisons should be ordered sent by express or freight, as poisons are not mailable.

FREIGHT SHIPMENTS

Should be used when possible on heavy goods. The saving will be considerable. Order early and allow plenty of time.

TERMS CASH WITH ORDER

Accounts cannot be opened for small amounts. Persons wishing to open accounts must furnish satisfactory references, and allow time for investigation before shipment can be made.

BAGS.

As a rule seeds are best shipped in strong cotton sacks holding up to two and one-half bushels each, and must be charged for at market price; present charge, 30 cents each. Burlap bags, 10c. each, are unsuitable for grass and other fine seeds.

WRITE ADDRESS PLAINLY

Write your Name, Post-Office and State plainly and in full on every letter. When Express or Freight Office is different from Post-Office, advise us of the same.

SEEDS, ETC., BY WEIGHT OR MEASURE.

Quarter-pound and one-quarter bushel will be charged at slight advance above pound and bushel rates—5 pounds at the 10-pound rate; 25 pounds at the 100-pound rate. Prices subject to market and changes without notice.

ABOUT WARRANTING SEEDS

We give no warranty, express or implied, as to description, quality, productiveness or any other matter of any Seeds, Bulbs or Plants we send out, and we will not be in any way responsible for the crop. If the purchaser does not accept the goods on these terms, they are to be returned at once.

THE FRANK S. PLATT COMPANY

SEEDSMEN

448-452 STATE STREET

:-: NEW HAVEN, CONNECTICUT

MERIT LIST

New Giant Imperial Larkspurs

A Great Advance in Annual Larkspurs.

BLUE SPIRE. An intense, deep Oxford Blue with the upright base branching habit that has made this group so popular as a cut flower. Blue Spire will undoubtedly prove to be the ideal deep blue color wanted by all, especially florists. Price per oz., \$2.00; per ¼-oz., 60c; pkt., 15c.

GLORIA. New addition to the Giant Imperial group. A rich tone of deep rose with no trace of carmine. Price per oz., \$4.00; per ⅛-oz., 60c; per pkt., 25c.

LILAC SPIRE. A beautiful lilac. Price per oz., \$2.00; per ¼-oz., 60c; per pkt., 15c.

PEACH BLOSSOM. Another 1932 addition to this wonderful Larkspur group. A clear light pink with no trace of salmon. Price per oz., \$4.00; per ⅛-oz., 60c; per pkt., 25c.

WHITE SPIRE. A new dazzling, pure white, double Larkspur with the improved, upright Delphinium-like habit. This is a welcome addition to the new group of column-like Larkspurs, as the long, straight, upright stems make it superior to all other white Larkspurs as a cut flower. Price per oz., \$1.50; per ¼-oz., 40c; per pkt., 15c.

Special Collection Offer. We consider this new type Larkspur one of the most satisfactory annuals it has been possible to offer in flower seeds for many years, and to en-

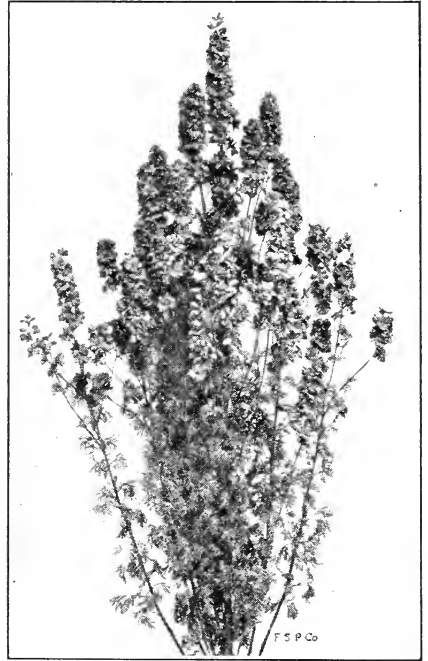

New Larkspur Gloria

Note the new upright type and many fine spikes.

courage greater use of these beautiful, easily-grown flowers, make the special Larkspur offer:

One packet each, the five new Larkspurs for 85c. One-eighth ounce each of above five for \$1.75.

Special Mixture. New Giant Imperial Larkspur including above and other shades in this new, unequalled class of Larkspurs. Price per oz., \$1.25; per pkt., 10c.

NOTE: Larkspurs do best if sown in open during early Winter or very early Spring.

New Marigold Guinea Gold

GUINEA GOLD. A distinctly different marigold which might be well called carnation-flowered. A feature of Guinea Gold is its graceful semi-double flowers of pure golden color. Plants produce no singles. The marigold odor is also less pronounced. The plant is of neat habit, erect, 2 to 2½ feet tall, very free blooming, with good stems for cut flowers; admired by all who saw it in our 1931 trials. Price per 1-16-oz., 50c; per pkt., 25c.



Guinea Gold

Giant Straightneck Squash.

There has been a greatly increased demand recently for a good strain of Giant Straightneck; a selection from the Crookneck Squash, but with a straight, thick, meaty neck instead of the crooked one. Our stock has been constantly improved in uniformity. It is decidedly better for shipping as well as in the kitchen. Fruits 15 to 18 inches; quick growing and tender. Price per pkt., 10c; per oz., 20c; per 1/4-lb. 55c; per lb., \$1.75.



Super Snowball Cauliflower.

Increased interest has been given recently to the growing of more Cauliflower in Connecticut and nearby states. Excellent crops have been grown and the importance of seed from finest possible strains shown. Our Super Snowball Cauliflower has been cited by large growers and agricultural experts alike as being a particularly fine strain, and every precaution will be used to keep up this reputation. For description see page 14. Price per pkt., 25c; per oz., \$2.75; per 1/4-lb., \$10.50; per lb., \$38.00.

Golden Plume Celery.

Authorities pronounce this the best Golden Self-Blanching Celery in existence, the result of more than twenty years' extreme care and selection. Golden Plume has taken first prize at National Vegetable Growers' Conventions. Our stock is an extra choice improved strain of "Golden Plume", also called "Wonderful" developed from originator's stock, and grown from best and earliest plants. It excels in combining earliness, size, attractive appearance and table quality. Golden Plume is blight-resistant and free from strings or hollow stalks. Per pkt., 10c; per oz., \$1.00; per 1/4-lb., \$2.75; per lb., \$10.00.

Easy Blanching Celery.



Growers realize one very important thing in connection with celery seed which can be produced very cheaply in some sections of the country. The trouble with such seed is that it is liable to produce many soft or hollow stalks. Growing seed from individual plant selections is more costly, but worth much more, as shown by the crops produced by our Easy Blanching Celery seed. The photo shows plants, taken at random, that weighed five pounds each, and many from the same field would weigh considerably more, and not a hollow stalk was found. Easy Blanching is about two weeks later than Golden Plume and should be used to follow that variety. Further description on page 15. Price per pkt., 10c; per oz., 35c.; per 1/4-lb., \$1.00; per lb. \$3.50.

IMPROVED HIGH QUALITY STRAINS CELERY.

Stringless Black Valentine Bean.

New 1930. A bean of better quality, similar in type to Black Valentine; a long, sleek, oval pod, completely stringless and attractive. It makes a strong appeal to the taste through its delicate flavor. A splendid heavy cropping variety for market gardeners. This year we have a supply at very moderate prices. Don't fail to give it a trial; increased production will soon make it available at regular prices. Price per pkt., 15c; per pt., 40c; per qt., 70c; per 10 lbs., \$2.90; per 100 lbs., \$26.00.

Chantenay Carrot.

For Connecticut markets and many other sections, the most extensively out-door-grown bunching carrot. While classed as a medium early, it is the earliest of its size. The true type, with its bright orange-scarlet root, 5½ to 6 inches long, gently tapering, is blunt ended and makes a very attractive appearance in bunches at the market. Through extreme care in stock selection for many years, our Chantenay is as fine a strain as can be offered. We take much satisfaction in being able to offer such seed. Price per pkt., 10c; per oz., 15c; per ¼-lb., 35c; per lb., \$1.00.

Golden Sunshine.

The most outstanding development in sweet corn since the introduction of the original Golden Bantam. Nine days earlier than Golden Bantam; slightly larger with quite uniformly twelve rows, instead of eight and possessing that superb quality of the original not found in other yellow sorts. We are conservative in these statements, for many claim it to be twelve or more days earlier and even better quality. In our trials it was a great surprise to find every claim for it fully justified and even more. Surely everybody should plant Golden Sunshine, whether for home or market. Price per pkt., 10c; per pt., 30c; per qt., 50c; per 10 lbs., \$2.30; per 100 lbs., \$20.00.

Early Surprise Sweet Corn.

In our estimation, the most valuable extra early white corn. According to trial ground tests, it is even earlier than the Early Dighton or Alpha. Seed planted May 22nd was ready in 69 days. A large attractive, strictly white ear with twelve rows; stalks 4 to 4½ feet tall. It surely is a winner for the market gardener. Price per pkt., 10c; per pt., 30c; per qt., 50c; per 10 lbs., \$2.30; per 100 lbs., \$20.00.

NOTE: Treat your seed corn with Semesan, particularly the extra early plantings. Results—less rot and better stand.

Longfellow Cucumber.

(New). An excellent, long, slender, dark green variety of the White Spine type, suitable for either greenhouse or outdoor culture. An ideal variety for the private garden or as a "straight pack" for shipment to high-grade markets. Cucumbers 12 to 14 inches long by 2½ inches diameter. Price per pkt., 15c; per oz., 25c; per ¼-lb., 75c; per lb., \$2.50.

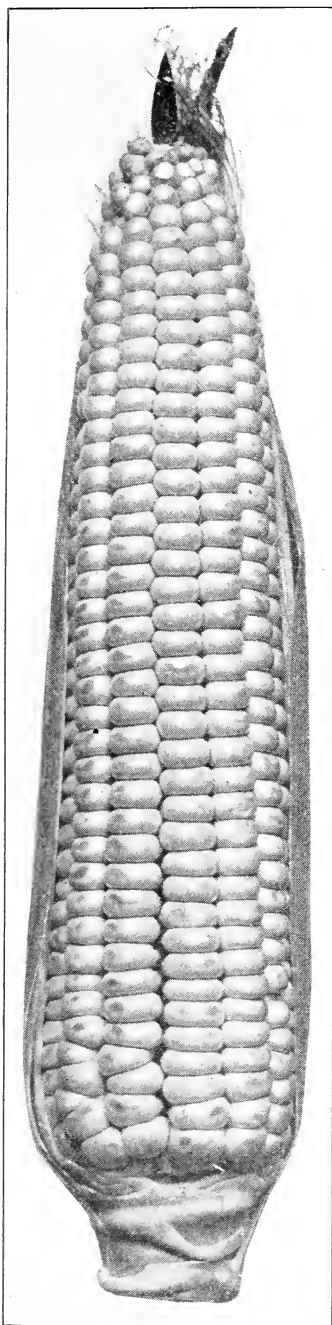

GOLDEN SUNSHINE.

***Golden Sunshine
nine days earlier
than the original
Golden Bantam***

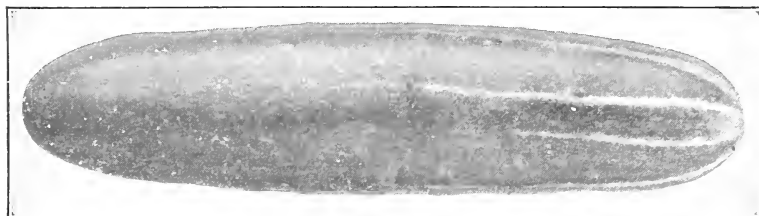

LONGFELLOW CUCUMBER.



EACH ALTERNATE ROW WAS SOWN TO RESELECTED LONG STANDING SAVOY SPINACH.
Note absence of seed stalks.

Long Standing Savoy Spinach.

In appearance the Longstanding Savoy is quite similar to Reselected Savoy; the leaves are more intensely green. It is a little more compact in growth and does not grow as rapidly but on account of nearly total absence of male plants it stands heat remarkably well. When other kinds have bolted to seed it does not even show the least inclination to shoot and will stand up and remain in prime condition a week to ten days longer. What this means to a market gardener is unnecessary to dwell on. First introduced in 1925 and now one of our leading kinds. Price per pkt., 10c; per $\frac{1}{4}$ -lb., 15c; per lb., 45c., 10 lbs. or more at market growers' rates.

Giant Thick Leaved Longstanding. (New). The Giant Thick Leaved has long been esteemed for its extreme hardiness and earliness for wintering over, but lacked much of the qualities indicated by the name as well as good attractive appearance. The new type grows as quickly as the other smooth-leaved varieties, but is far superior because of standing up longer. Leaves are very large, broad and thick. Sold also under the name of Noble Spinach. Price per pkt., 10c; per $\frac{1}{4}$ -lb., 15c; per lb., 45c; 10 lbs. or more at market growers' rates.

Virginia Yellows-Resisting Savoy. In many localities this is the only sort that can be grown successfully during the early fall and is therefore immensely valuable for that reason. The plant type, appearance and uniformity have been greatly improved since first introduced. It seems necessary, however, to advise against its use except during early fall for fall cutting. Wintered over or spring sown, it bolts quickly to seed. Price per pkt., 10c; per $\frac{1}{4}$ -lb., 15c; per lb., 45c; 10 lbs. or more at market growers' rates.

Platt's Evergreen Lawn Seed.

Best formula for general purposes. Contains heavy-grade, thoroughly re-cleaned seeds only of Kentucky Blue Grass, Red Top, Rhode Island Bent, White Clover and Italian Rye Grass. The many beautiful lawns that have been produced with Platt's Evergreen Lawn Seed about private homes, churches, universities and public buildings are proofs of the exceptionally high-grade and suitable seeds used in the formula. This seed weighs 28 pounds per bushel and used commonly at the rate of $\frac{1}{8}$ bu. per 1,000 sq. ft., 4 bushels per acre. Price per pt., 25c; per qt., 40c; per $\frac{1}{8}$ -bu., \$1.35; per $\frac{1}{4}$ -bu., \$2.50; per $\frac{1}{2}$ -bu., \$4.75; per bu., \$9.50

GENERAL LIST OF PLATT'S SELECT VEGETABLE SEEDS

Artichoke.

Artichoke—Carciofo—Alcachofa.

Tuberous Rooted Artichoke. Jerusalem Artichoke. This is quite distinct from the Globe Artichoke, being grown exclusively for its tubers; perfectly hardy. Price per lb., 20c.; per 10 lbs., \$1.75.

Large French Globe (Perennial). The flower heads are the edible portions, and are cooked like asparagus. Sow during February and March and transplant after danger from frost in rows three feet apart, and two feet between the plants. It requires a deep, rich loam, and slight winter protection. Plants not usually productive after third year. Price per pkt., 10c.; per oz., 65c.

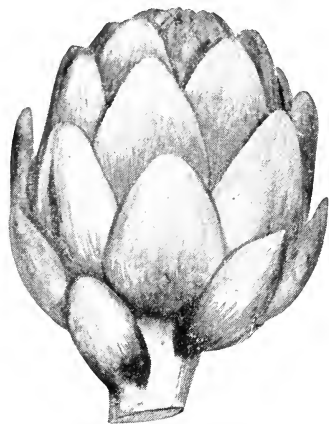

GLOBE ARTICHOKE.

Asparagus.

Sow early, in drills about one inch deep, and rows about a foot apart. In the fall or succeeding spring the plants may be set out in beds about two feet apart each way, leaving the crown of the root about four inches below the surface. Before winter cover the bed with a dressing of manure.

Purchasing roots instead of seeds will save a year in time.

Mary Washington. The newest and finest variety in cultivation. The greatest improvement ever made in asparagus, combines rust-resistance, great size and table qualities, heretofore never approached. Dr. Norton of the U. S. Department of Agriculture developed the rust-resistant Martha Washington and later Mary Washington, which is so much better than any other it remains only to become more generally known, when it will supersede all others. Price per pkt., 10c.; per oz., 20c.; per ¼-lb., 40c.; per lb., \$1.50.

Giant Argenteuil. French origin; very early; purple. Blanches readily. Price per pkt., 10c.; per oz., 15c.; per ¼-lb., 30c.; per lb., \$1.00.

Bonvalettes' Giant. Large, vigorous, early white or pale green. Price per pkt., 10c.; per oz., 15c.; per ¼-lb., 30c.; per lb., \$1.00.

Palmetto. Very early, large and pale green. Price per pkt., 10c.; per oz., 15c.; per ¼-lb., 25c.; per lb., 85c.

Asparagus Roots.

Strong one-year-old roots are recommended.

Inasmuch as large, well-grown, one-year-old roots are better than two or three-year-old roots, and that genuine, true Mary Washington is unquestionably the best sort in existence, there is no good reason for offering any other. Roots grown from ordinary seed, sown thickly, can be sold at about half our prices, but it does not pay to use such roots.

Asparagus Roots.

| | | |
|---|--------|---------|
| Mary Washington. Large one-year- | 100. | 1,000. |
| old roots | \$2.00 | \$15.00 |
| Shipping weight, 9 lbs. per 100 roots. | | |



MARY WASHINGTON ASPARAGUS.

Bush Beans.

Bohnen—Frigole—Fagioli.

DWARF OR SNAP.

A succession of sowing can usually be made from the first week in May until August in Connecticut. Plant in drills $1\frac{1}{2}$ to 2 inches deep and from eighteen inches to $2\frac{1}{2}$ feet apart, according to the richness of the soil and method of cultivation. The plants should be about three inches apart. Use about one quart to each 250 feet of drill.

WAX PODDED VARIETIES.

Crackerjack. (Webber Wax). One of the earliest. Stringless wax, bright yellow, semi-round, podded, 6 inches long, hardy, prolific and fine quality; seed yellow. Very popular with truckers about New Haven. Also one of the best for home gardens. Price per pt., 35c.; per qt., 60c.; 10 lbs., \$2.30; 100 lbs., \$20.00.

Sure Crop Wax. Very desirable, high quality bean. A selection from and superior to Currie's Rust Proof; black-seeded, pods 6 to 7 inches long, flat, fleshy and stringless. Plant hardy, productive, a few days later than Currie's. Price per pt., 35c.; per qt., 60c.; 10 lbs., \$2.30; 100 lbs., \$20.00.

Pencil Pod Black Wax. Pods 6 to 7 inches long, straight and very tender. In color a golden yellow; the best quality round-podded, black-seeded wax. Price per pt., 35c.; per qt., 60c.; per 10 lbs., \$2.30; per 100 lbs., \$20.00.

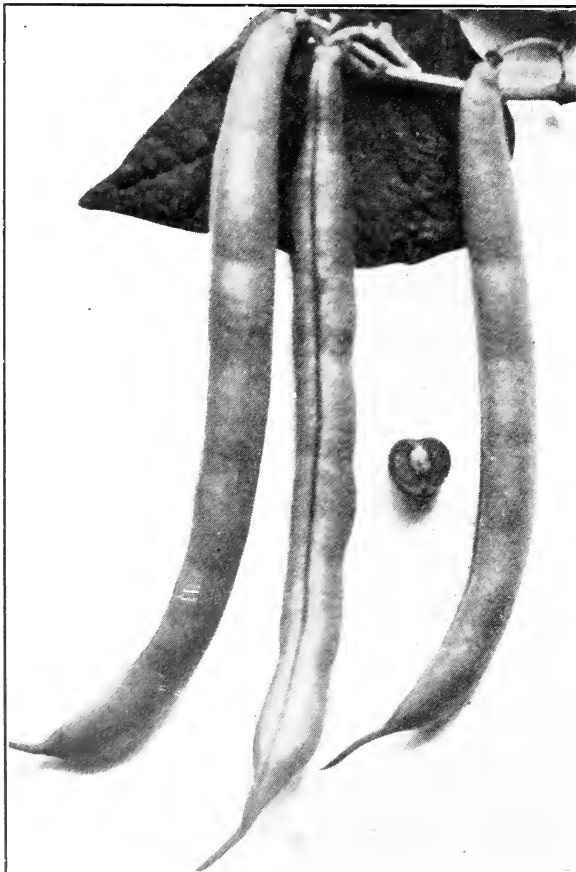

FULL MEASURE.

A SECOND EARLY GREEN POD OF FINEST QUALITY

Note—Not less than 5 pounds beans sold at the 10-pound rate, or 25 pounds at the 100-pound rate. Postage extra on Beans, Sweet Corn and Peas, except in pkts. Beans and Peas weigh about 2 lbs. per qt.; Sweet Corn $1\frac{1}{2}$ lbs. Add for postage according to zone. (See page 2).

Pkts. any variety Beans, 15c. each

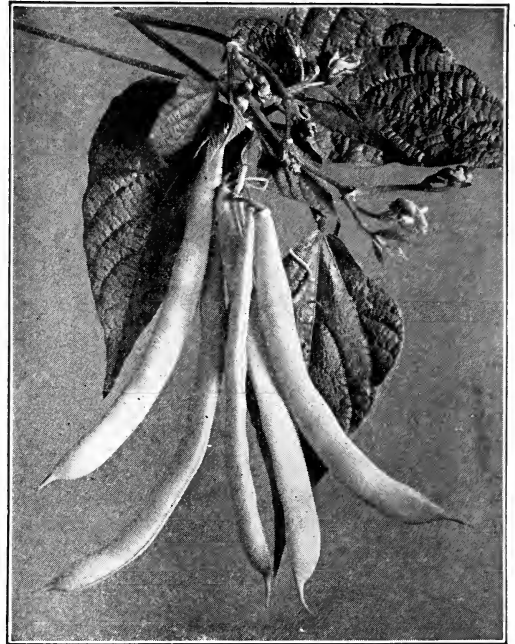

CRACKERJACK WAX.

Round Pod Kidney Wax. (Brittle Wax). Early, round podded, 5 to 6 inches long, stringless and of fine quality. Seed white with very little brownish black marking at the eye. Price per pt., 35c.; per qt., 60c.; 10 lbs., \$2.40; 100 lbs., \$21.00.

Wardwell's Kidney Wax. Pods attractive, 6 inches long, broad, flat, nearly stringless; medium early. Beans white, mottled with purple. Per pt., 35c. per qt., 60c.; 10 lbs., \$2.30; 100 lbs., \$20.00.

Improved Golden Wax. Thick, straight, broad pods, 4 to $4\frac{1}{2}$ inches long, seed mottled. Price per pt., 35c.; per qt., 60c.; 10 lbs., \$2.30; 100 lbs., \$20.00.

Davis White Kidney Wax. Handsome flat pods, 6 to 7 inches long, seed white, very productive; has considerable string and fibre; valued principally as a market gardener's sort, or excellent shell bean. Price per pt., 35c.; per qt., 60c.; 10 lbs., \$2.30; 100 lbs., \$20.00.

Hodson Wax. Long, semi-round, straight, light yellow pods, very late, quality fair. Price per pt., 35c.; per qt., 60c.; 10 lbs., \$2.30; 100 lbs., \$20.00.

GREEN PODDED VARIETIES.

Stringless Black Valentine. New. A bean of better quality, similar in type to Black Valentine; a long, sleek, oval pod, completely stringless and attractive. It makes a strong appeal to the taste through its delicate flavor. A splendid heavy cropping variety for Market Gardeners. Limited supply. Price per pt., 40c.; per qt., 70c.; 10 lbs., \$2.90; 100 lbs., \$26.00.

Black Valentine. Very hardy and productive. Extra early. Vigorous vine; pods straight and semi-round, not stringless. A large crop can be depended on. Per pt., 30c.; qt., 55c.; 10 lbs., \$2.10; 100 lbs., \$18.00.

Bountiful. Pods $6\frac{1}{2}$ to 7 inches long, slightly curved, stringless, excellent quality. Seeds bright yellow. Continues to bear over a longer period than most sorts; suitable for home or market. The best second early flat green pod. Per pt., 35c.; per qt., 60c.; 10 lbs., \$2.30; 100 lbs., \$20.00.

Beans—Continued.

Pkts. any variety Beans 15c. each.

Stringless Green Pod. Very early. The pods are round, five inches long and brittle. Fine quality. Per pt., 35c.; per qt., 60c.; 10 lbs., \$2.30; 100 lbs., \$20.00.

Low's Champion. Flat pods, usually five inches long, entirely stringless and very tender. Price per pt., 35c.; per qt., 60c.; 10 lbs., \$2.30; 100 lbs., \$20.00.

Full Measure. In our opinion, the highest quality round green podded bean in existence. The pods are absolutely stringless, slightly curved and average 6 inches long. In season it is a second early, being about one week later than Bountiful. Full Measure has a rare combination of extreme tender fleshiness and flavor. Useful for your second early and succession crops. Price per pt., 35c.; per qt., 60c.; 10 lbs., \$2.30; 100 lbs., \$20.00.

Refugee Stringless Green Pod. Late, heavy cropping, round pod, fine quality, absolutely stringless, dark seed. Price per pt., 35c.; per qt., 60c.; 10 lbs., \$2.30; 100 lbs., \$20.00.

Dwarf Horticultural. Large round beans in fine mottled pods; used mostly as an early shell bean. Per pt., 35c.; per qt., 60c.; 10 lbs., \$2.30; 100 lbs., \$20.00.

French Horticultural. An excellent shell bean. Pods 7 to 8 inches long; broad, marked with vivid carmine. Very attractive appearance but stringy and fibrous, thus not adapted as a snap bean. Per pt., 35c.; qt., 60c.; 10 lbs., \$2.70; 100 lbs., \$24.00.

Large White Kidney or Royal Dwarf. One of the best shell beans, green or dried. Price per pt., 30c.; per qt., 60c.; 10 lbs., \$2.30; 100 lbs., \$20.00.

Red Kidney or Chilian. Cultivated as a field bean and used dry; the flavor is distinctly fine quality. Per pt., 30c.; per qt., 50c.; 10 lbs., \$1.70; 100 lbs., \$14.00.

Yellow Eye. Generally grown as a field variety; very productive and superior quality for boiling or baking. Price per pt., 30c.; per qt., 50c.; 10 lbs., \$1.80; 100 lbs., \$15.00.

White Pea or Navy. Boston baking bean. Per pt., 30c.; per qt., 50c.; 10 lbs., \$1.70; 100 lbs., \$14.00.

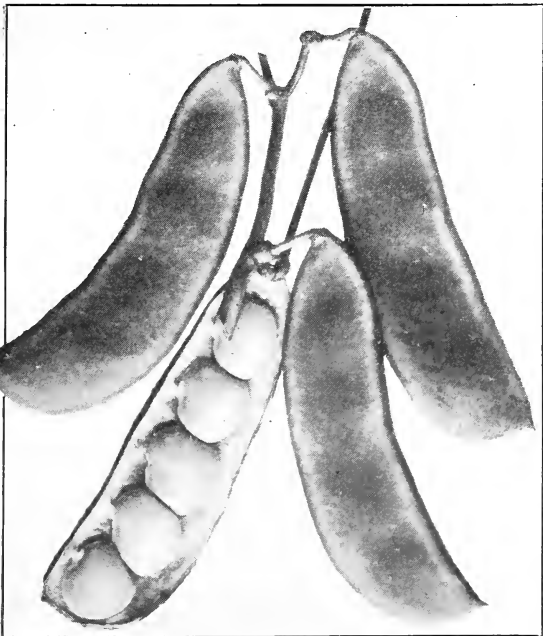

FORDHOOK BUSH LIMA.

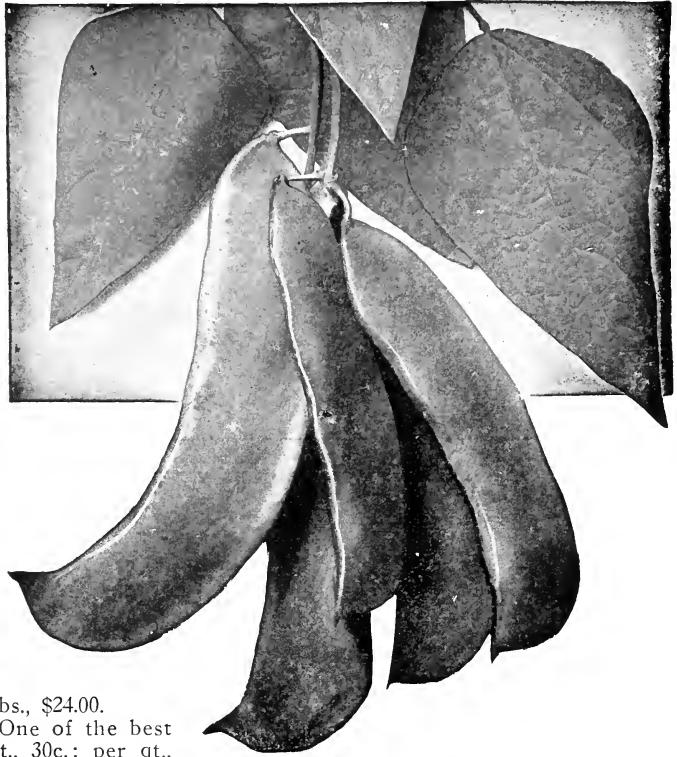

White Marrow. Best adapted to field culture and sale in dry state. Per pt., 30c.; per qt., 50c.; 10 lbs., \$1.80; 100 lbs., \$15.00.

ENGLISH OR BROAD.

Broad Windsor. A bush or stump variety; ripens unevenly, thus prolonging the season. Thrives best in good rich, rather damp soil. (Bu., 50 lbs.). Per pkt., 15c.; per pt., 35c.; per qt., 65c.; 10 lbs., \$2.90.

Dwarf or Bush Lima.

Burpee's Bush Lima. 18 in. to 2 ft. high. Original large-seeded bush lima. Seed flat, 3 to 4 in. pod; 4 to 4½ in. long. Per pt., 35c.; per qt., 60c.; 10 lbs., \$2.50; 100 lbs., \$22.00.

Burpee's Improved Bush Lima. A true bush lima; when fully grown about 24 in. high; pods borne abundantly 5 to 6 in. long by 1¼ wide. Beans larger, much thicker than old type and will outyield it by nearly a third; in season about one week earlier; quality finest. Per pt., 35c.; per qt., 65c.; 10 lbs., \$2.60; 100 lbs., \$23.00.

Fordhook Bush. The vigorous upright plants come into bearing early and produce an abundant continuous crop of pods borne in clusters well up from the ground. Pods are from 4 to 5 in. long; thick and heavy, as they are tightly filled with three to five seeds of excellent quality. Type preferred in the market, and Fordhooks are more extensively grown by market gardeners in the East than any other variety. Lima beans were one of our specialties before the first bush lima was introduced, and we take special pride in the quality of our stocks. Price per pkt., 15c.; per pt., 35c.; per qt., 65c.; 10 lbs., \$2.70; 100 lbs., \$24.00.

Henderson's Bush Lima. Small, flat-seeded. It is the earliest of the limas. Price per pt., 30c. per qt., 55c.; 10 lbs., \$2.20; 100 lbs., \$19.00.

Beans—Continued.

Pkts. any variety Pole Beans 15c. each

POLE OR RUNNING.

They succeed best in sandy loam, which should be liberally enriched with thoroughly rotted manure in the hills, which are formed according to the variety, from three to four feet apart.

Platt's King of the Garden Lima. Early and prolific; pods large, 6 to 8 inches long, bearing four to six, sometimes seven beans. Introduced by us in 1883. Now widely known, and continues to be the general favorite pole lima

Early Leviathan. Earliest large pod, containing 5 to 6 white beans

Carpinteria or Ideal. Long pods containing 4 or 5 green-tinted seeds of finest flavor

Small Lima or Sieva. A small-seeded early variety, immensely productive, excellent also for dried shell beans; called butter beans in the South

Scarlet Runner. The beans are very dark; flowers bright scarlet; very ornamental; is also used as a snap of fine quality when young. Plants of strong, quick growth. (Bu., 50 lbs.)

Dutch Case Knife. Early and prolific, long, flat pods with white seeds; best as a green or dry shell bean

Lazy Wife. Pods four to five inches in length, rather broad, thick and fleshy, entirely stringless. The dry beans are round and pure white

Mammoth Horticultural or Speckled Cranberry. Pods stringless, striped with red, seeds oval, medium size; suitable for snap or shell

Kentucky Wonder or Old Homestead. Immensely productive; large green pods, 8 to 9 inches long, round, fleshy, finest quality, stringless until nearly mature; one of the best green podded pole snaps; seeds light brown

Burger's Green Pod. White-seeded Kentucky Wonder

Early Golden Cluster. Pods from six to eight inches long; attractive, straight, fleshy, flat and stringless, golden yellow, seeds white

French Yard Long. Curious slender green pods, two to three feet long; requires long season. Per pkt., 15c.

| | Pt. | Qt. | 10 lbs. | 100 lbs. |
|---|------|------|---------|----------|
| Platt's King of the Garden Lima | 35c. | 60c. | \$2.40 | \$21.00 |
| Early Leviathan | 35c. | 60c. | 2.40 | 21.00 |
| Carpinteria or Ideal | 35c. | 60c. | 2.40 | 21.00 |
| Small Lima or Sieva | 30c. | 55c. | 2.20 | 19.00 |
| Scarlet Runner | 35c. | 60c. | 2.50 | 22.00 |
| Dutch Case Knife | 35c. | 60c. | 2.40 | 21.00 |
| Lazy Wife | 35c. | 60c. | 2.30 | 20.00 |
| Mammoth Horticultural or Speckled Cranberry | 30c. | 55c. | 2.20 | 19.00 |
| Kentucky Wonder or Old Homestead | 30c. | 55c. | 2.20 | 19.00 |
| Burger's Green Pod | 35c. | 60c. | 2.30 | 20.00 |
| Early Golden Cluster | 35c. | 65c. | 2.60 | 23.00 |

Beets.

Pkts. any variety Beet 10c. each

Runkle Rube—Remolecha—Bietoli

The beet is used in all stages of its growth. All the varieties succeed best in a deep, rich sandy loam, and requires thinning when small and kept free from weeds. For early beets sow as soon as the ground will admit, in drills fourteen inches apart, and thin to four inches distant. For winter use sow in May or June.

Extra Early Flat Egyptian.

The earliest beet in cultivation; for forcing or transplanting; flat, tender when young; very dark red; small tops; a market sort. Crosby's and Early Wonder are of better table quality

| | Oz. | ¼-lb. | Lb. |
|-----------------------------------|------|-------|--------|
| of better table quality | 15c. | 30c. | \$1.00 |

Crosby's Egyptian. An improved type of the Egyptian Beet. A flattened globe in shape, deep red; fine quality early sort, for home or market bunching

| | | |
|------|------|------|
| 15c. | 30c. | 1.00 |
|------|------|------|

Early Wonder. A select strain of the Crosby type; only a few days later than the Extra Early Egyptian. Our stock has been persistently selected for the qualities sought by market gardeners; a flattened globe in shape, dark red color, earliness and uniformity; tops small; an ideal bunching variety

| | | |
|------|------|------|
| 15c. | 30c. | 1.00 |
| 15c. | 30c. | 1.00 |

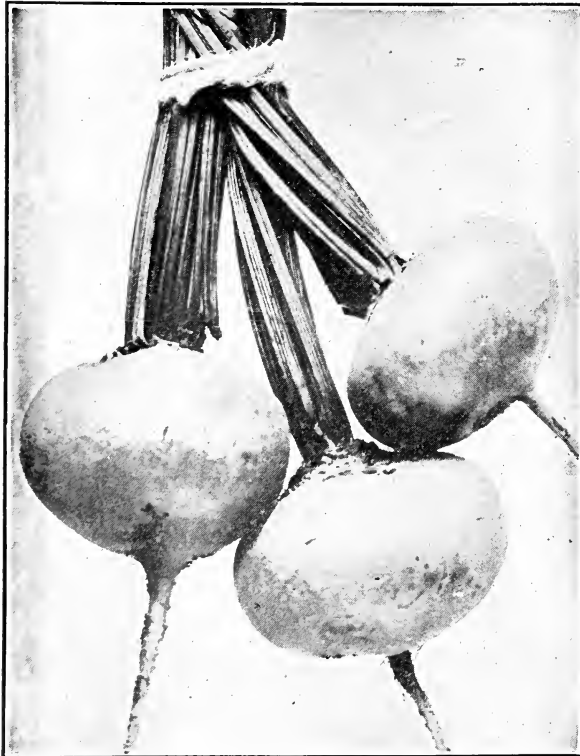

EARLY WONDER BEET.

Crimson Globe. The flesh is fine grained, dark crimson, with skin of lighter shade.

Detroit Dark Red. Tops small; roots ovoid and smooth; color dark blood red; best for main crop, remaining tender longer than the early sorts

Eclipse. Early; dark red, small tops, almost spherical

Edmand's Blood Turnip. Deep blood skin, and very dark flesh; excellent keeper

Early Blood Turnip. A good variety for general use

Early Bassano. Flesh circled with bright red and white, flat, large tops adapted for use as greens

| | | |
|------|------|------|
| 15c. | 30c. | 1.00 |
| 15c. | 30c. | 1.00 |
| 15c. | 25c. | .85 |
| 15c. | 25c. | .85 |
| 15c. | 25c. | .85 |
| 15c. | 25c. | .85 |



SWISS CHARD LUCULLUS IMPROVED.

ing 30 to 40 tons per acre of valuable food for stock; roots grow well above ground, therefore easy to harvest. Per oz., 10c.; per ¼-lb., 20c.; lb., 60c.

Giant Sludstrup. An orange yellow sort, ovoid in shape, not the largest in bulk yield, but excels in amount of dry matter per acre yield. Price per oz., 10c.; per ¼-lb., 20c.; per lb., 60c.

Golden Tankard. Half long nearly uniform diameter from top to bottom. Price per oz., 10c.; per ¼-lb., 20c.; per lb., 60c.

Sugar Beets.

White French Sugar. For feeding or beet sugar, making one of the richest in sugar content. Price per oz., 10c.; per ¼-lb., 20c.; per lb., 60c.

Lane's Improved Imperial Sugar. An American selection from the French Sugar Beet. Price per oz., 10c.; per ¼-lb., 20c.; per lb., 60c.

Klein Wauzeben Sugar. Long, medium size; color, rosy orange; very sweet. Price per oz., 10c.; per ¼-lb., 20c.; per lb., 60c.

Broccoli.

Spargel Kohl—Brocoli—Broccoli.

Broccoli is closely allied to cauliflower; succeeds only under cool, damp conditions. Sow thinly in seed beds about the middle of spring, transplant and cultivate according to directions for winter cabbage.

Early White Cape. The heads when full grown are large, white and compact. Price per pkt., 10c.; per oz., 60c.; per ¼-lb., \$1.75.

Early Green Calabrese. Entirely distinct from the above sorts. Cultivated for its green bud clusters and tender terminal leaves. The main stalk cluster when cut encourages many side sprouts with smaller clusters. Price per pkt., 10c.; per oz., 90c.; ¼-lb., \$2.50; per lb., \$9.00.



BROCCOLI CALABRESE.

Brussels Sprouts.

Rosenkohl—Berza de Brussels—Brocoli di Cavolo.

The plants grow two or three feet high and produce, from the sides of the stalk, numerous little sprouts one or two inches in diameter, resembling cabbages. The leaves look like the Savoy, and should be broken down in the fall, to give the little cabbages more room to grow.

Dalkeith. Dwarf, compact, producing large sprouts. Price per pkt., 10c.; per oz., 20c.; per ¼-lb., 55c.; per lb., \$1.75.

Beets—Continued.

Dewing's Early Blood Turnip. Deep blood red; good for summer, autumn or winter. Per oz., 15c.; per ¼-lb., 25c.; per lb., 85c.

Early Yellow Turnip. Flesh yellow. Per oz., 15c.; per ¼-lb., 25c.; per lb., 85c.

Half Long Blood. Late variety and finest quality for winter use; smooth skin; flesh dark red, sweet and exceptionally tender. Per oz., 15c.; per ¼-lb., 30c.; per lb., \$1.00.

Swiss Chard or Spinach Beet.

Cultivated for its leaves. The mid-rib is boiled and served like asparagus, and the other portions of the leaves are used as spinach. When wanted, cut close down to the ground without injury to the crown, and new leaves will grow continuously from early summer until frost.

Swiss Chard or Silver. This is the smooth-leaved variety. Per pkt., 10c.; per oz., 15c.; per ¼-lb., 30c.; per lb., \$1.00.

Giant Lucullus Improved. The rib and stem are very wide, pearly white and tender. A great improvement over the old sort. Large dark green, crumpled leaf. Price per pkt., 10c.; per oz., 15c.; per ¼-lb., 40c.; per lb., \$1.25.

Beets--Mangel Wurtzel.

For Feeding Stock.

Red Globe. A large, round, red-skinned variety. Price per oz., 10c.; per ¼-lb., 20c.; per lb., 60c.

Mammoth Long Red. Grows to an enormous size, producing an enormous amount of food for stock; roots grow well above ground, therefore easy to harvest. Price per oz., 10c.; per ¼-lb., 20c.; per lb., 60c.



MAMMOTH LONG RED MANGEL.

Cabbage.

Kopfkohle—Berza de Repeollo—Cappucie.

The Cabbage requires a deep, rich soil and thorough working. For early use the plants should be started in a hotbed or cold frame; but seed for winter cabbage should be sown in a seed bed for Connecticut the last of May and transplanted when 4 to 6 inches high. Some of the large late varieties seem to do well if the seed is sown in the hills where they are to remain, and in that case sow two or three seeds where each plant is desired, and then pull up all but the strongest. Plant the large varieties three feet apart; the small, early sorts from a foot to eighteen inches. The Savoy cabbages have crumpled leaves, and are of fine flavor, especially after a little frost has touched them in the autumn.

Golden Acre Cabbage. The earliest round headed cabbage, similar in type, somewhat smaller, and ten days earlier than Copenhagen Market. Price per pkt., 10c.; per oz., 40c.; per ¼-lb., \$1.10; lb., \$4.00.

Copenhagen Market. Exceptionally hard and solid, round heads; average eight pounds each, of fine quality, few outer leaves, small core and nearly as early as Jersey Wakefield, with greater yield, also desirable for fall and early winter use. Our seed is grown for us in Denmark, where the finest stocks of Copenhagen Market Cabbage are produced. Price per pkt., 10c.; per oz., 30c.; per ¼-lb., 85c.; per lb., \$3.00.

Early Jersey Wakefield. Heads very solid, pyramidal, blunted at the top. The best and most popular early pointed head. Our stock is especially bred for earliness and uniformity. Price per pkt., 10c.; per oz., 30c.; per ¼-lb., 85c.; per lb., \$3.00.

Charleston or Large Wakefield. Similar to Early Jersey Wakefield, but larger and a little later. Price per pkt., 10c.; per oz., 30c.; per ¼-lb., 85c.; per lb., \$3.00.

All Head Early. A large, flat, early summer variety of fine quality, good keeper if sown late. Price per pkt., 10c.; per oz., 30c.; per ¼-lb., 85c.; per lb., \$3.00.

All Seasons. The heads of this cabbage are large and thick through, a desirable sort for kraut. Price per pkt., 10c.; per oz., 25c.; per ¼-lb. 75c.; per lb., \$2.50.

Glory of Enkhuizen. An excellent, second early, two weeks later than Copenhagen Market. The large round, solid, very uniform head, with short stem and few outer leaves, allows close planting. It is a good cropper and adapted not only as a second early but for fall and early winter use. Price per pkt., 10c.; per oz., 30c.; per ¼-lb., 85c.; per lb., \$3.00.

Early Summer. Medium early, good size, of the Drumhead order. Price per pkt., 10c.; per oz., 30c.; per ¼-lb., 85c.; per lb., \$3.00.

Surehead. Large, thick, flattened heads of flat Dutch type. Per pkt., 10c.; oz., 30c.; ¼-lb., 85c.; lb., \$3.00.

Succession. A large, second early drumhead, sure heading sort for summer and fall use. Price per pkt., 10c.; per oz., 30c.; ¼-lb., 85c.; per lb., \$3.00.

Danish Ball Head. Medium stem. (Fine Danish-grown seed). Late, round, hard-headed; the longest keeper and finest quality. Seed should be sown two weeks earlier than for Flat Dutch or most other late. Per pkt., 10c.; per oz., 30c.; per ¼-lb., 85c.; per lb., \$3.00.

Premium Flat Dutch. Heads large, solid. A standard variety. Per pkt., 10c.; per oz., 25c.; per ¼-lb., 75c.; per lb., \$2.50.

SAVOY, OR CURLING VARIETIES.

Perfection Drumhead Savoy. Reliable, large, round, late heading, densely crumpled. The Savoy Cabbage is of richer quality and should be more extensively grown. Takes about same time to make crop as the Danish Ball Head. Per pkt., 10c.; oz., 30c.; ¼-lb., 85c.; lb., \$3.00.

RED VARIETIES.

Mammoth Rock Red. Heads large, round and thick, very dark from surface to center. Sow seed same time as for Ball Head. Per pkt., 10c.; per oz., 35c.; per ¼-lb., \$1.00; per lb., \$3.50.

CHINESE CABBAGE.

Pe Tsai. Sometimes called Chinese celery cabbage, though resembling more nearly the Cos Lettuce; used as a salad or cooked as cabbage. Sow seed about July 1 in this latitude, as if sown early it runs to seed. Transplant to 12 inches apart in the row. Per pkt., 10c.; per oz., 35c.; per ¼-lb., \$1.00; per lb., \$3.50.



EARLY JERSEY WAKEFIELD.



COPENHAGEN MARKET CABBAGE.

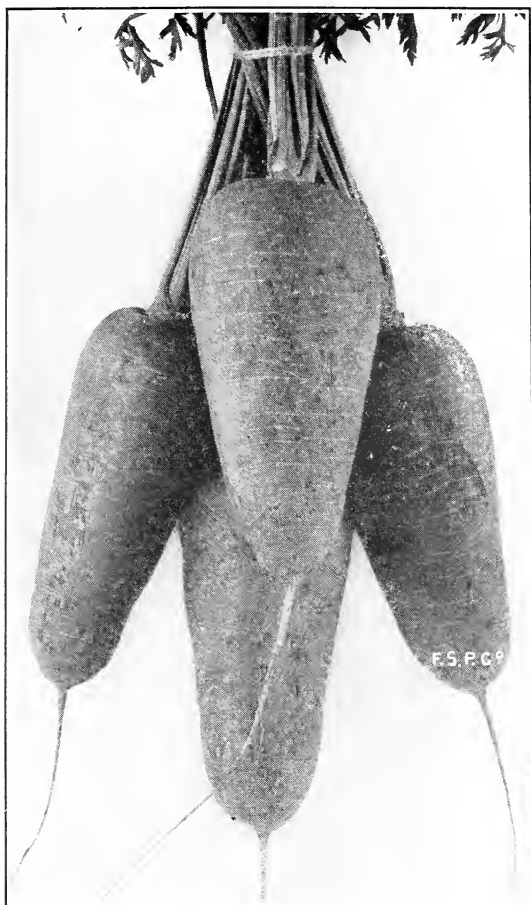

CHANTENAY CARROT.

early as the very small sorts. Chantenay is most extensively used for bunching, but if allowed to develop fully yields a heavy crop. Price per pkt., 10c.; per oz., 15c.; per ¼-lb., 35c.; per lb., \$1.00.

Chantenay Red Cored. To develop a carrot with the sturdiness and fine qualities of Chantenay, but with a red core, which would be as palatable and attractive as Nantes, has been something to be desired. That task, after several years, has resulted in offering Red Cored Chantenay. We recommend you consider it for your use. Price per pkt., 10c.; per oz., 15c.; per ¼-lb., 50c.; per lb., \$1.50.

Danvers Half-Long. The best known second early or main crop variety, popular with our trade, both private and market. Roots are bright orange scarlet, seven to eight inches long, tapering gently, stump or semi-pointed. A heavy yielder and good keeper, of fine quality for winter use. Price per pkt., 10c.; per oz., 15c.; per ¼-lb., 30c.; per lb., \$1.00.

Hutchinson. A very large, nearly cylindrical, stump-rooted carrot, 10-12 inches in length; good color and immensely productive. Price per pkt., 10c.; per oz., 15c.; per ¼-lb., 50c.; per lb., \$1.50.

Long Orange Improved. Large size, tapering to a point of deep orange color, and adapted to garden or field culture. A valuable food for stock. Price per pkt., 10c.; per oz., 15c.; per ¼-lb., 35c.; per lb., \$1.00.

White Giant, Green Top. Used for feeding stock; one of the best because of its enormous productiveness. Price per pkt., 10c.; per oz., 15c.; per ¼-lb., 30c.; per lb., 90c.

Cardoon.

Kardon—Cardo—Cardone.

Cardoon is grown for the midrib of the leaf, and requires blanching in the same manner as celery. Sow early in the spring, where the plants are to remain, in drills about three feet apart, an inch and a half deep, and thin out the young plants to a foot apart in drills.

Large Spanish. Price per pkt., 10c.; per oz., 30c.; per ¼-lb., 85c.; per lb., \$3.00.

Carrots are an All Season vegetable. It is carrot planting time from March until July. The young carrot is now a regular member of the menu all over the country, an all season vegetable, and it is never so good, so tender, so well-flavored, as when freshly pulled. Baby carrots take up little space and plantings at intervals will keep a supply all season.

Carrots.

Mochre—Zanahoria—Carote.

The carrot, like other root crops, delights in a sandy loam, deeply tilled. For early crops sow in the spring, as soon as the ground is in good working order; for late crops they may be sown any time until the middle of June. Sow in rows about fifteen inches apart.

French Forcing. The earliest, small, almost round, two inches long, fine flavor and color. Price per pkt., 10c.; per oz., 15c.; per ¼-lb., 35c.; per lb., \$1.25.

Early Scarlet Horn. An early summer variety; color deep orange; roots grow about three inches long. Price per pkt., 10c.; per oz., 15c.; per ¼-lb., 35c.; per lb., \$1.25.

Nantes. Stump rooted, early, almost cylindrical, about six inches long by 1½ inches diameter. Flesh is deep orange, very tender and sweet, of finest quality. Price per pkt., 10c.; per oz., 15c.; per ¼-lb., 35c.; per lb., \$1.25.

Guerrande or Oxheart. Very large at the top, three to five inches long and terminating abruptly. Price per pkt., 10c.; per oz., 15c.; per ¼-lb., 35c.; per lb., \$1.00.

Chantenay or Model. An excellent and popular, quick-growing carrot of fine table quality. The roots average 2½ inches diameter by 6 inches long; have a slight shoulder; taper gently to near the tip, then terminate abruptly into a fine small root. The flesh is deep orange, crisp and tender. Roots are suitable for use almost as

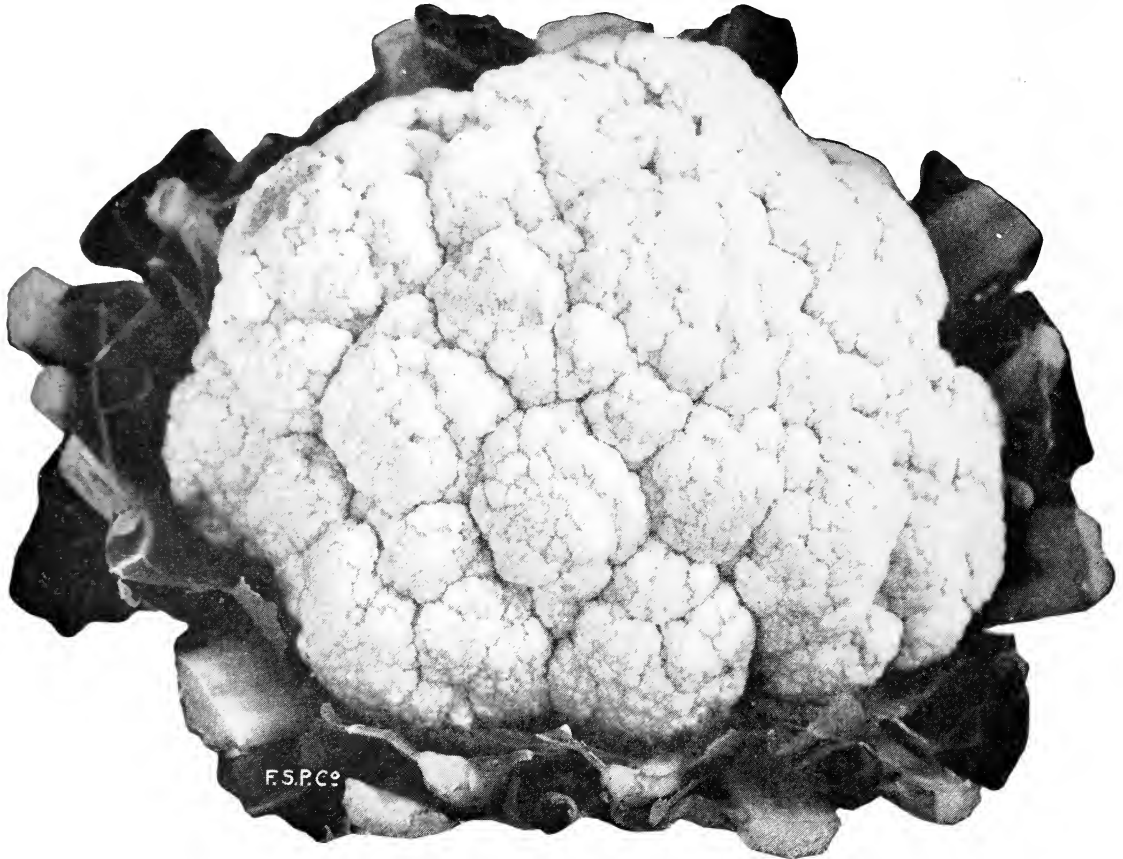

SNOWBALL CAULIFLOWER.

Cauliflower.

Blumen Kohl—Coliflor—Cavolfiore.

Should be sown according to instructions for cabbage. It will thrive best in cool, moist situations.

Early Snowball. The finest early variety and more generally grown than any other. Handsome, almost snow-white. Heads of medium size, firm and well formed. Plant is compact, short-stemmed, with few short upright leaves. Keen competition among growers has produced several excellent strains, some of which are offered on the market under various names. However, careful comparisons on Long Island, in Connecticut and New York State show our strain to be a stock of superior quality and well suited to this territory. Price per pkt., 25c.; per oz. \$2.50; per ¼-lb., \$7.00; per lb., \$25.00.

Super Snowball. This new Snowball is a real marvel in earliness and simultaneousness in heading. In trials the past two seasons it has headed from two to three weeks sooner than the earliest stocks with which we are acquainted and so simultaneously throughout the field that nothing like it has ever been seen before. Moreover, the heads are large, deep and solid and the foliage is strong and vigorous, forming a good protection. Price per pkt., 25c.; per oz., \$2.75; per ¼-lb., \$10.50; per lb., \$38.00.

Early Dwarf Erfurt. An excellent stock of the Snowball type, though not so early. Price per pkt., 20c.; per oz., \$2.00; per ¼-lb., \$6.00; per lb., \$22.00.

Danish Giant. (Dry Weather). It is well known that a constant moisture supply in the soil is necessary to a successful Cauliflower crop. It has been found, however, that Danish Giant will stand more unfavorable conditions in this respect than either Snowball or Erfurt. It is about two weeks later and fully twenty per cent larger heading, produced on a much larger plant. The head is pure white and of fine quality. Price per pkt., 25c.; per oz., \$2.50; per ¼-lb., \$8.00; per lb., \$27.00.

Celeriac or Turnip-Rooted Celery.

A variety of celery, having turnip-shaped roots which may be cooked, or sliced and used with vinegar, making a most excellent salad. It is a more hardy, and may be treated in the same manner as celery.

| | Pkt. | Oz. | Lb. |
|--|------|------|--------|
| Turnip-Rooted. Turnip-shaped and well flavored | 10c. | 20c. | \$2.00 |
| Large Prague. Nearly round, smooth and good quality | 10c. | 20c. | 2.00 |

Celery.

Seleri—Apios—Sedanio Acci.

Sow seeds in hotbed or very early in open ground (it is slow to germinate, and should be kept moist). Sow in straight rows for convenience in weeding when plants are small. When five or six inches high thin out or transplant to five inches apart. Celery requires very rich soil and plenty of water.



GOLDEN PHENOMENAL.

Emperor. A late, excellent keeping variety of outstanding merit. Plants stocky, 15 to 18 inches tall, and therefore easily handled. Foliage dark green; stalks white, thick and crisp, without strings. Flavor is unsurpassed. Price per pkt., 10c.; per oz., 40c.; per ¼-lb., \$1.10; per lb., \$4.00.

Giant Pascal. Stocky, vigorous plants, dark green foliage, stalks solid and after blanching a rich golden yellow; crisp and tender. A standard of fine quality and flavor for late winter use. Price per pkt., 10c.; per oz., 30c.; per ¼-lb., 85c.; per lb., \$3.00.

Winter Queen. Medium height, thick, light green, solid stalks, with a large heart crisp, blanches well. Price per pkt., 10c.; per oz., 35c.; per ¼-lb., 75c.; per lb., \$2.50.

Celery Seed. For flavoring. Old Seed. Price per oz., 10c.; per lb., 75c.; per 100 lbs., \$65.00.

Plants may be set from May to the middle of August. Large growers set the crop level with the surface, having previously plowed in all the manure possible, and setting in rows three to four feet apart and five or six inches in the row.

Golden Plume. Authorities pronounce this the best golden self-blanching celery in existence; the result of more than twenty years' extreme care and selection. Golden Plume has taken first prize at several National Vegetable Growers' Conventions. Our stock is an extra choice improved strain of "Golden Plume," also called "Wonderful" developed from originator's stock, and grown from best and earliest plants. It excels other self-blanching sorts in earliness, size, attractive appearance and table quality. Golden Plume is blight-resistant, and free from strings or hollow stalks. Price per pkt., 10c.; oz., \$1.00; ¼-lb., \$2.75; lb., \$10.00.

Florida Golden. Florida Golden is the same in season as Golden Plume, which it resembles. The great difference is that the edible portion of the stem is longer and the plant remains in condition longer than Golden Plume. Florida Golden is just a little taller than Golden Plume and a very great improvement over that variety. The plants are full-hearted, blanch to a rich cream color of exceptionally fine quality and excellent flavor. The stems are crisp and free from strings. Price per pkt., 25c.; per oz., \$1.75; per ¼-lb., \$5.00; per lb., \$18.00.

Golden Self-Blanching. Original strain. French-grown seed. For many years the leading early golden yellow celery. Dwarf compact habit, numerous stalks, large solid heart blanching easily. Our seed is grown by the originator. Per pkt., 10c.; per oz., \$1.00; per ¼-lb. \$2.75; per lb., \$10.00.

Easy Blanching. A very select strain of this valuable early green celery. The plants are from 20 to 24 inches tall, uniform in size, full hearted, crisp, rich in flavor, maturing early, blanching in ten days to two weeks; a light golden yellow, free from pithy stalks and keeping well until after the holidays. The seed offered is a very select strain. Price per pkt., 10c.; per oz., 35c.; per ¼-lb., \$1.00; per lb., \$3.50.

White Plume. Very early; blanching easily, the leaves to an attractive greenish white, the stalks nearly white; quality fair. Price per pkt., 10c.; per oz., 35c.; per ¼-lb., \$1.00; per lb., \$3.50.

Chervil.

Gartenkerbel—Perifollo—Cerfoglio.

Cultivated and used like parsley. The young leaves are used for flavoring. For summer use sow in March, and in July for winter.

Curled. Price per pkt., 10c.; oz., 20c.; lb., \$1.75.

Chives.

Schnettlauch—Cibollino.

Chives are perfectly hardy little perennial members of the onion tribe, and are grown exclusively for their tops, which are used whenever the flavor of onion is required. Planted in small clumps in any common garden soil, they will grow rapidly, and in time increase so as to render a division necessary. The tops appear very early in spring, and can be cut through the season.

Roots only, per bunch, 15c. Postage extra, ½-lb each.

Chicory.

Cichorten—Cicoria.

The roots of this vegetable are much used as a substitute for coffee. The young leaves are also used for salad.

Large Rooted or Coffee. Per pkt., 10c.; oz., 15c.; ¼-lb., 50c.; lb., \$1.50.

Chufas or Earth Almonds.

Resemble in sweetness and flavor a cocoanut. Very prolific, a single one yielding from one to two hundred. Plant 1 ft. to 18 in. apart.

Chufas. Price per oz., 10c.; per lb., 50c.

Collards or Coleworts.

Junge-Kohl—Cabu—Cavolo.

A variety of cabbage greens, used extensively in the south.

True Creole or Southern. Price per pkt., 10c.; per oz., 15c.; per lb., \$1.00.

Sweet Corn.

Pkts. any variety Sweet Corn 10c. each
except where noted.*Zucher Mais—Mais Granone volce.*

It is generally conceded that Connecticut grown seed sweet corn is of superior quality. Seed is produced here in large quantities for shipment to the most critical trade.

EXTRA EARLY VARIETIES.

Early Surprise. A valuable extra early white corn. Early Surprise, according to trial ground tests, is even earlier than the Early Dighton or Alpha. Seed planted May 22nd was ready in 69 days. A large, attractive, strictly white ear with 12 rows; stalks 4 to 4½ feet. It surely is a winner for the market gardener. Price per pt., 30c.; per qt., 50c.; 10 lbs., \$2.30; 100 lbs., \$20.00.

Mayflower. Very early white, good-sized ears, 10 to 12 rowed. Stalks 4 to 5 feet high, hardy and popular early. Per pt., 30c.; per qt., 50c.; 10 lbs., \$2.30; 100 lbs., \$20.00.

Whipple's White. An early white corn ready five days after Early Mayflower or about five days earlier than Early Crosby. Ears rather blocky, 8 inches long, with 16 to 18 rows, well filled to the tip with deep grains of excellent quality. Per pt., 30c.; per qt., 50c.; 10 lbs., \$2.30; 100 lbs., \$20.00.

Whipple's Yellow. A decided improvement in yellow sweet corn; ready about same time as Golden Bantam, but nearly twice the size; ears 7 to 8 inches long, 12 to 16 rowed. The quality is excellent. Price per pt., 30c.; per qt., 50c.; 10 lbs., \$2.30; 100 lbs., \$20.00.

Golden Bantam. Original type. Medium size, 8-rowed, ears of finest quality, which has never been improved on in that respect. The seed when dry is a beautiful golden color. Many prefer it to the larger sorts and make successive plantings every two weeks up to July 15 for this vicinity. Price per pt., 30c.; per qt., 50c.; 10 lbs., \$2.30; 100 lbs., \$20.00.

Golden Sunshine. The most outstanding development in sweet corn since the introduction of the original Golden Bantam. Nine days earlier than Golden Bantam; slightly larger with quite uniformly twelve rows instead of eight and possessing that superb quality of the original not found in other yellow sorts. We are conservative in these statements, for many claim it to be twelve or more days earlier and even better quality. In our trials it was a great surprise to find every claim for it fully justified and even more. Surely everybody should plant Golden Sunshine, whether for home or market. Price per pkt., 15c.; per pt., 30c.; per qt., 50c.; 10 lbs., \$2.30; 100 lbs., \$20.00.

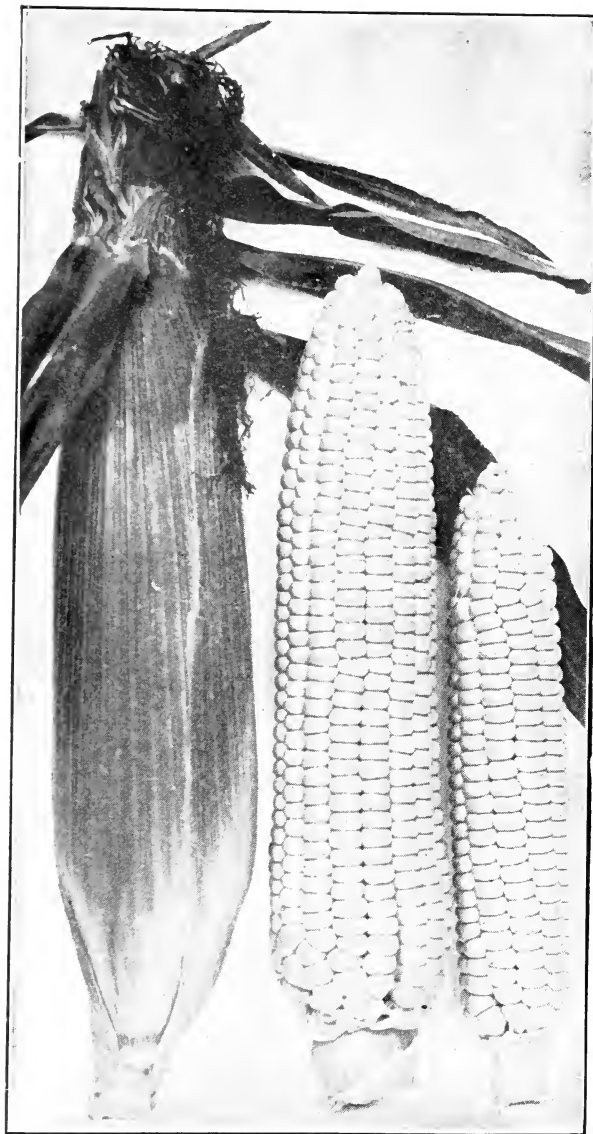

WHIPPLE'S YELLOW. GOLDEN BANTAM.

MEDIUM VARIETIES.

Crosby's Early. Very sweet, fine grains, grows ten to twelve rows on a medium sized ear, averaging seven inches long. Per pt., 30c.; per qt., 50c.; 10 lbs., \$2.30; 100 lbs., \$20.00.

Bantam Evergreen. A cross between Golden Bantam and Stowell's Evergreen, giving us a corn of fine quality and good size, ears 7 to 8 inches long. Ready about the same time as Howling Mob. Price per pt., 30c.; per qt., 50c.; 10 lbs., \$2.30; 100 lbs., \$20.00.

Howling Mob. One of the large-eared, early twelve-rowed class of much merit and a profitable crop for the trucker. Price per pt., 30c.; per qt., 50c.; 10 lbs., \$2.30; 100 lbs., \$20.00.

Metropolitan. One of the sweetest and largest of the second earliest; twelve-rowed. Price per pt., 30c.; per qt., 50c.; 10 lbs., \$2.30; 100 lbs., \$20.00.

Potter's Excelsior or Squantum. Medium early. Large ears of excellent quality. Price per pt., 30c.; per qt., 50c.; 10 lbs., \$2.30; 100 lbs., \$20.00.

Mexican Sugar. Black. Medium early and very sweet; eight-rowed; when young the color is very slight. Price per pt., 30c.; per qt., 50c.; 10 lbs., \$2.30; 100 lbs., \$20.00.

Note—Not less than 5 pounds Corn sold at the 10-pound rate or less than 25 pounds at the 100-pound rate. Postage extra on Sweet Corn, Beans and Peas, except in pkts. Beans and Peas weigh about 12 lbs. per qt.; Sweet Corn 1½ lbs. Add for postage according to zone (see page 2).

Sweet Corn—Continued.

LATE VARIETIES.

Platt's Fancy Evergreen. A very superior strain earlier and more productive than Stowell's. Price per pt., 30c.; per qt., 50c.; 10 lbs., \$2.50; 100 lbs., \$22.00.

Stowell's Evergreen. A large variety, 8 to 9 inches long; the standard late for family or market use; of highest quality. Price per pt., 30c.; per qt., 50c.; 10 lbs., \$2.10; 100 lbs., \$18.00.

Country Gentleman. (Shoe Peg). Medium late; good size ears, irregularly crowded full of slender, deep grains, deliciously sweet and finest flavored. Price per pt., 30c.; per qt., 50c.; 10 lbs., \$2.30; 100 lbs., \$20.00.

Long Island Beauty. A very late corn with immense ears, often 12 inches long, sixteen or eighteen rows of pearly white grain, tender and delicious, in an attractive dark green husk. A most excellent sort for home canning. Price per pt., 30c.; per qt., 50c.; 10 lbs., \$2.30; 100 lbs., \$20.00.

Sweet Corn for Fodder. The sweet corn fodder is decidedly preferred by stock to the field varieties. Price per 10 lbs., \$1.00; per 100 lbs., \$7.00.

Pop Corn Selected for Seed.

Granone per Scoppio.

White Rice. Sharp-pointed kernels, twelve to sixteen-rowed, more generally grown than any other. Price per lb., shelled, 20c.

Red Beauty. Sharp-pointed kernels, twelve to sixteen-rowed. An improved red rice, considered by many the finest of all, being very free from tough fibre; pops large, and delicately flavored. Price per lb., shelled, 20c.

Queen's Golden Pop. Twelve to sixteen-rowed, smooth kernel, bright yellow. Price per lb., shelled, 20c.



EUERKA ENSILAGE CORN.

Corn--Varieties for Field Culture.

Granone e Grano—Turco.

Note. Seed Corn postpaid to any post office within 150 miles for 60c. per bu. extra, plus cost of bag—2 bu. burlap, 10c.; cotton 35c. It pays to use improved seed. Our corn has been especially grown for seed. Prices subject to market fluctuations.

FLINT VARIETIES.

Early Eight-Rowed Yellow Canada or 90-Day Corn. The Flints will always be favorites for certain uses and conditions. Earliness and ability to yield well on light ground; they have qualities that make the finest grade of meal (Indian meal). Will produce a profitable crop where the later and heavier sorts would be a failure. Early Canada is the earliest of these Qt. Bu. (56 lbs.) 25c. \$4.50

Longfellow. The ears are larger and longer than Early Canada, cob small, kernels large; eight-rowed yellow flint 25c. 4.00

Improved Sanford. Large white ears, 12 to 15 inches long, very productive and producing also a good leafy growth 25c. 4.25

DENT VARIETIES.

Queen of the Prairie or Pride of the North. This is an early Yellow Dent, medium size, uniform ears, cob small; a winner in many shelling contests 25c. 3.00

Improved Leaming. Select stock. The ears are large, with deep dented grain, twelve to sixteen-rowed. Extensively grown for both grain and silo. Matures in 100 to 110 days 25c. 3.00

Sweepstakes Ensilage. Earliest big-eared Dent, heavy producing silage corn for Connecticut and north. It is very important to secure seed of superior quality produced only in limited areas of Northeastern Pennsylvania. This stock grows 12 to 15 feet high, and produces in 90 to 100 days, 15 to 20 tons per acre, silage of high food value, containing a large amount of grain in the glazed stage, considered ideal 25c. 4.00

Eureka Ensilage. One of our specialties, an extra large southern corn grown and selected with great care to keep the true vigorous stock. White seed, luxuriant and heavy in stalk and foliage. Will ordinarily produce more tons of ensilage than any other. We have had stalks 17 feet 10 inches tall 25c. 3.50



CORN SALAD OR FETTICUS.

Corn Salad or Feticcus.

Ackersalat—Macha o Valerianilla
—*Valerianello o Insalata.*

It is sown on the first opening of spring in rows one foot apart, and is fit for use in six weeks from the time of sowing. If wanted for very early spring, it may be sown in September and covered as soon as cold weather sets in, and is wintered over the same as spinach.

Large Leaved. Price per pkt., 10c.; per oz., 15c.; per $\frac{1}{4}$ lb., 50c.; per lb., \$1.50.



CRESS OR PEPPER GRASS.

Cress or Pepper Grass.

Kresse—Berro o Masteurso—Crescione.

Extensively used as a small salad. Sow early in the spring, very thickly in shallow drills. The sowing should be repeated at intervals, as it soon runs to seed. One ounce of seed will sow a bed of sixteen square feet.

Extra Curled. Fine curly-leaved. Price per pkt., 10c.; per oz., 15c.; per lb., 80c.

Upland. Resembles the water cress in flavor; same culture as spinach; a perennial plant. Price per pkt., 10c.; per oz., 20c.; per lb., \$1.75.

Cress--Water.

Wasser Kresse—Crescione Acquatico.

This is a well-known hardy, perennial aquatic plant, growing abundantly along the margins of running streams, ditches and ponds. Where it



WATER CRESS.

does not grow naturally it is easily introduced by planting, and it increases, both by spreading of the roots, and by seeding.

True Water Cress. Price per pkt., 10c.; per oz., 45c.; per lb., \$4.50.



EARLY FORTUNE CUCUMBER.

Cucumbers.

Garken—Pepino—Cetriolo.

Make rich hills of well-rotten manure, two feet in diameter, and plant a dozen or more seeds, covering half an inch deep. When all danger from insects is over, pull all but three or four of the strongest plants. The middle of June is early enough to plant for pickling. Make the hills about six feet apart. For early cucumbers the hot-bed is necessary.

EARLY AND SMALL PICKLING VARIETIES.

Early Cluster. Very early; short and sets closely. Price per pkt., 10c.; per oz., 15c.; per $\frac{1}{4}$ -lb., 40c.; per lb., \$1.25.

Boston Pickling or Green Prolific. Medium long, smooth, good color. Price per pkt., 10c.; per oz., 15c.; per $\frac{1}{4}$ -lb., 40c.; per lb., \$1.25.

Cucumber—Continued.

Gherkins or West India. Very small, fruit covered with spines, and used for pickles only; extremely prolific; the vine resembles the watermelon and may be run over an arbor or trellis. Price per pkt., 10c.; per oz., 20c.; per ¼-lb., 55c.; per lb., \$1.75.



LONGFELLOW CUCUMBER.

FOR SLICING AND LARGE PICKLES.

Early White Spine. Large, bright green, smooth and prolific. Price per pkt., 10c.; per oz., 15c.; per ¼-lb., 40c.; per lb., \$1.25.

Evergreen White Spine. Extra long and straight, dark green. Price per pkt., 10c.; per oz., 15c.; per ¼-lb., 40c.; per lb., \$1.25.

Arlington Early White Spine. For slicing or pickling. Price per pkt., 10c.; per oz., 15c.; per ¼-lb., 40c.; per lb., \$1.25.

Japanese Climbing. Vines are vigorous and throw out strong, grasping tendrils. Fruits long, even and crisp. Price per pkt., 10c.; per oz., 15c.; per ¼-lb., 50c.; per lb., \$1.50.



DAVIS PERFECT CUCUMBER.

Early Fortune. This belongs to the white spine type, and is the finest yet produced for general use. It is early, productive and blight-resisting; remarkably uniform fruits about nine inches long by two and one-half in diameter, holding their fine dark green color long after pickling; flesh firm, crisp, and few seeds. Owing to its vigor and blight-resisting qualities, we believe is due the high percentage of perfect fruits. Our market gardeners shipping to New York and Brooklyn markets have found it to be their most profitable sort. Price per pkt., 10c.; per oz., 15c.; per ¼-lb., 50c.; per lb., \$1.50.

Davis Perfect. A fine, extra long, solid, smooth and slender, dark green type of White Spine, equally good for field or forcing culture. The fault with the original strain, which was inclined to be necky, has been entirely overcome by several years' selection. Price per pkt., 10c.; per oz., 15c.; per ¼-lb., 50c.; per lb., \$1.50.

Longfellow Cucumber. (New). An excellent, long, slender, dark green variety of the White Spine type, suitable for either greenhouse or outdoor culture. An ideal variety for the private garden or as a "straight pack" for shipment to high-grade markets. Cucumbers 12 to 14 inches long by 2½ inches diameter. Price per pkt., 15c.; per oz., 25c.; per ¼-lb., 75c.; per lb., \$2.50.

Improved Long Green. A dark green, productive late table sort, twelve to fifteen inches long, more or less warted; flesh white and firm; used extensively for large pickles. Price per pkt., 10c.; per oz., 15c.; per ¼-lb., 40c.; per lb., \$1.25.

Dandelion.

Lowenzahn—Amaigon—Cicorea.

The Dandelion affords one of the earliest as well as one of the best and most healthful spring greens. It is also sometimes blanched and used as a salad. The seeds may be sown from May to August, in drills ten inches apart; thin out the young plants to about three inches apart; cultivate during the

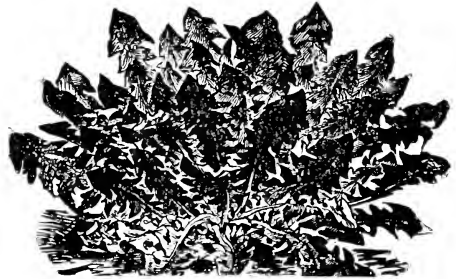

DANDELION.

season, and the following spring the plants will be fit for the table.

French Common. Very early, vigorous growth. Per pkt., 10c.; oz., 30c.; ¼-lb., 50c.; lb., \$1.50.

Improved Thick-Leaved, or Cabbaging. Distinct variety forming a regular upright tuft at the center; blanches easily. Superior to the common. Per pkt., 10c.; per oz., 60c.; per ¼-lb., \$1.75; per lb., \$6.00.

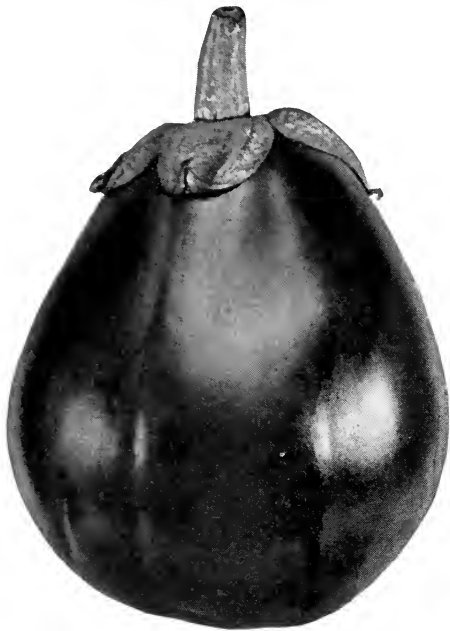

IMPROVE NEW YORK SPINELESS.

middle of June and again about the middle of July; and for plants to stand the winter, sow early in August. When the plants are about two inches high, transplant into rich, well-prepared soil.

Green Curled. Leaves curly and finely fringed; the center blanches readily to a cream color. Very hardy and fine quality. Price per pkt., 10c.; per oz., 15c.; per ¼-lb., 40c.; per lb., \$1.25.

Giant Fringed or Oyster. Beautifully fringed; vigorous; with large white heart. Price per pkt., 10c.; per oz., 15c.; per ¼-lb., 40c. per lb., \$1.25.

Broad-Leaved Batavian (Escarole). A large fleshy-leaved sort, deep green, more or less twisted and folding, forming a crisp sort of head in the center, which blanches to a creamy white. A very desirable salad plant belonging to the chicory family. Price per pkt., 10c.; oz., 15c.; ¼-lb., 40c.; lb., \$1.25.

Egg Plant.

Eierpflanze—Berengena—Melanzana

Sow in a hot-bed in February and March; when the plants are one or two inches high, transplant or thin out to two or three inches apart. When the weather is warm and settled, they may be planted out in a warm situation, two feet apart each way.

Improved New York Spineless. Fruit large size, oval and dark purple. Price per pkt., 10c.; per oz., 50c.; per ¼-lb., \$1.35; per lb., \$5.00.

Black Beauty. Fruit ten to fifteen days earlier than New York, not quite as large, more nearly egg shaped, dark purple. Price per pkt., 10c.; per oz., 50c.; per ¼-lb., \$1.35; per lb., \$5.00.

Early Long Purple. Fruits average 6 to 8 inches long and 2½ inches in diameter, early and productive. Price per pkt., 10c.; per oz., 50c.; per ¼-lb., \$1.35; per lb., \$5.00.

Endive.

Endivien—Endixia—Indivia o Escarola.

Make the first sowing about the middle of May, on a bed of well-pulverized, rich soil, scattering the seed thinly, and covering it lightly. For the main crop, sow in the



GREEN CURLED ENDIVE.

BROAD LEAVED BATAVIAN
ENDIVE.

French Endive. (See Witloof).

Florence or Naples Fennel.

Finnocchio di Napoli.

Sow in early spring in rows fifteen to twenty inches apart, in rich, moist soil. Thin out or transplant to six or eight inches. It is usually boiled for the table. It somewhat resembles celery, possessing a sweet and agreeable smell and flavor. Eaten raw when young and tender. Price per pkt., 10c.; per oz., 20c.; per ¼-lb., 60c.; per lb., \$2.00.

Garlic.

Aglio.

Garlic thrives best in a light, well-enriched soil; the sets should be planted in early spring, in rows one foot apart and from one to five inches in the rows. The crop matures in August, when it is harvested like the onion.

Garlic Sets. Price per lb., 40c.; postage extra.

Kale or Borecole.

Blatter Kohl—Col—Cavalo Riccio.

Sow in April, in drills fourteen to eighteen inches apart, covering the seeds thinly and evenly, and thin out when hoeing to from four to six inches apart. The varieties are extremely hardy, and are best when touched by frost. For winter and spring use, sow in August or September.

Extra Dwarf Curled Scotch. Spreading habit, hardy and improved by light frost. Price per pkt., 10c.; per oz., 15c.; per ¼-lb., 35c.; per lb., \$1.00.

Bloomdale Curled Scotch. An improved type of the Extra Dwarf Curled Scotch. The very curly dense foliage is a darker, more attractive color. It is also more hardy than the Dwarf Scotch. Per pkt., 10c.; oz., 15c.; per ¼-lb., 40c.; per lb., \$1.25.

Tall Curled Scotch. Similar to the Dwarf except that it grows two to three feet high. Price per pkt., 10c.; oz., 15c.; ¼-lb., 40c.; per lb., \$1.25.

Improved Siberian. German Greens or Spouts. Dwarf, curly, dark green leaves, very hardy and an immense cropper. Undoubtedly the most hardy and more extensively grown than any other variety; in fall seeding to winter over and cutting for spring greens. Per pkt., 10c.; oz., 15c.; ¼-lb., 25c.; lb., 85c.

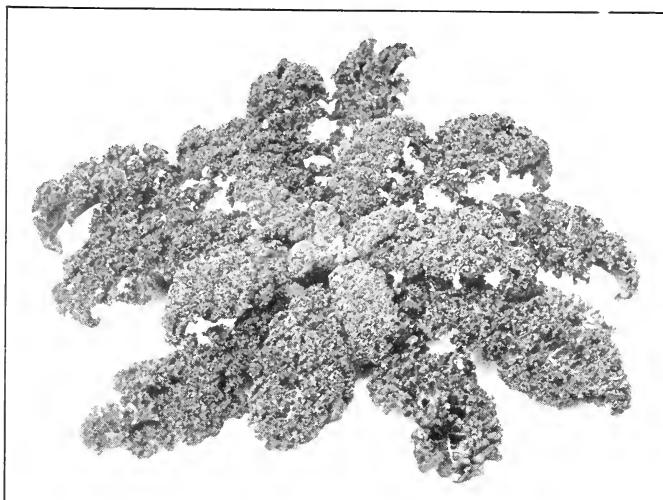

EXTRA DWARF CURLED SCOTCH.

Kohl-Rabi or Turnip Cabbage. *Kohlrabi—Colinabo—Rapa.*

Half-way between a turnip and a cabbage, partaking of the nature and flavor of both. The bulbs, formed above ground, are cooked like turnips. Sow from April to July; plant and cultivate the same as cabbage. As they are difficult to transplant, they are usually sown where they are to stand, and afterwards thinned out.

Early White Vienna. Grows to a fair size, skin light green; flesh white; short stumps and tops. Per pkt., 10c.; per oz., 20c.; per ¼-lb., 55c.; per lb., \$1.75.

Early Purple. Differs from the above in color only. Per pkt., 10c.; oz., 25c.; ¼-lb., 65c.; lb., \$2.25.

Leek.

Lauch—Porro—Cipollette.



LARGE MUSSELBURG LEEK.

Sow as early in the spring as season permits, either in seed beds or places where they are intended to grow. When four inches in height thin to three inches; when from six to eight, transplant to ten inches apart, leaving those in drills about six inches apart. Set as deep as possible without covering the small center leaves.

American Flag. A favorite variety, long, large stalk, broad-leaved, white and when properly blanched. Per pkt., 10c.; oz., 25c.; ¼-lb., 65c.; lb., \$2.25.

Large Musselberg. Thick, long stems, productive. Per pkt., 10c.; oz., 25c.; ¼-lb., 65c.; lb., \$2.25.

Giant Carentan. Largest and most hardy, semi-bulbous, mild. Per pkt., 10c.; per oz., 25c.; per ¼-lb., 65c.; per lb., \$2.25.

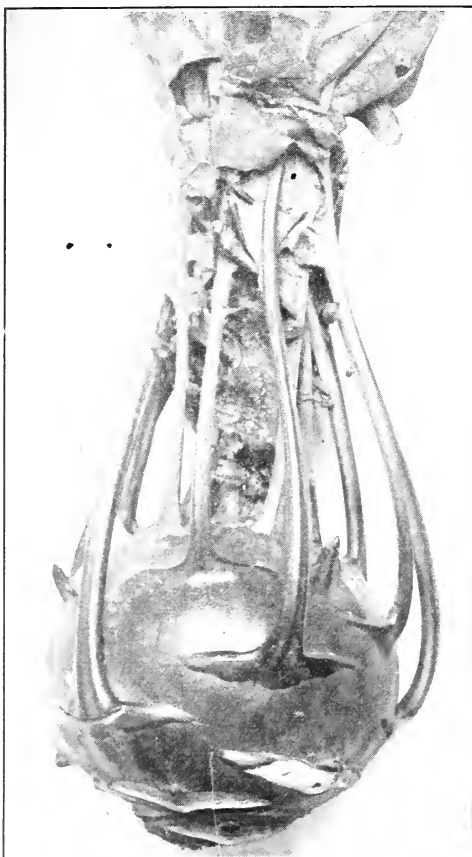

KOHL-RABI OR TURNIP CABBAGE.

Lettuce.

Kopfsalat—Lechuga—Lattuga.

Culture. Sow early in spring in a hot-bed; transplant in April for summer use. Again, sow from April at intervals in the open ground, and for winter and spring use, in August and September. Protect by means of cold frame during the winter.

CURLED OR LOOSE-LEAVED VARIETIES.

Grand Rapids. The plant is distinct, of upright growth; leaves light green, much fringed and crumpled, forming a loose cluster. Very extensively grown under glass. The seed will not grow if sown more than one-eighth inch deep. Price per pkt., 10c.; per oz., 20c.; per ¼-lb., 60c.; per lb., \$2.00.



Prize Head Early. Of non-heading habit, large bronzed leaves, crisp and tender. Price per pkt., 10c.; oz., 20c.; ¼-lb., 50c.; lb., \$1.50.

Simpson Black-Seeded. Rapid growing; stands the summer heat well, and attains a large size; quality excellent. Price per pkt., 10c.; per oz., 20c.; per ¼-lb., 50c.; per lb., \$1.50.

Simpson White-Seeded or Silesia. Very tender and crisp, forming loose cluster. Per pkt., 10c.; per oz., 20c.; per ¼-lb., 50c.; per lb., \$1.50.

HEADING OR CABBAGE VARIETIES.

Big Boston. Medium large cabbage butter-head type, finely shaped globular, medium light green smooth leaves, with a slight tinge of brown on margins on the outer leaves. Interior of the head is brittle, buttery and golden yellow. It is early, hardy and stands shipping well. Big Boston is recommended

UNRIVALLED, GREEN LEAVED BIG BOSTON LETTUCE.

for spring and autumn and for cold frame forcing, but not during the hot weather

| | | | | |
|--|------|------|------|--------|
| California Cream Butter or Royal Cabbage. Large-leaved, light green, buttery | 10c. | 20c. | 55c. | \$2.00 |
| Crisp-as-Ice. (Hartford Bronze). A bronze head variety of finest quality and appearance, the crumpled, shiny bronze leaves enclose a firm, crisp head of medium size. | 10c. | 20c. | 75c. | 2.50 |
| Deacon. A large Butter-Head variety. Pale yellow center of fine quality | 10c. | 20c. | 50c. | 1.50 |
| Hanson. Heads very large and solid; one of the most desirable crisp head variety for late home use. | 10c. | 20c. | 55c. | 1.75 |
| Mammoth Black-Seeded Butter. A yellowish green, compact head of large size and excellent quality | 10c. | 20c. | 55c. | 1.75 |
| May King. Early, light green, head solid, good shipper | 10c. | 20c. | 55c. | 1.75 |
| New York or Wonderful. A distinct, very large, flatish globular head; outer leaves dark green frilled at the edge, inner portion crisp, compact, beautifully blanched and tender; of excellent quality; stands hot weather well. It is also known as Los Angeles and is the variety grown extensively on the Pacific Coast for eastern markets, where it is reported 6,000 carloads were produced in the Imperial Valley alone last season and sold under the name of Iceberg. However, that name belongs to another sort, which leads to confusion. | 10c. | 25c. | 65c. | 2.25 |

Salamander. (Black Seeded Tennisball).

A compact, medium large, light green cabbage, butter-head, of excellent quality; withstands hot weather well; one of the most popular

| | | | |
|------|------|------|------|
| 10c. | 20c. | 55c. | 1.75 |
|------|------|------|------|

White Boston (Unrivalled.) A new and greatly improved strain of this important, very attractive cabbage butter-head of excellent quality, medium large size, light green, ten days earlier than Big Boston, with no tinge of brown. It is often called Green Leaved Big Boston. May be used at any time of the year, stands hot weather remarkably well

| | | | |
|------|------|------|------|
| 10c. | 20c. | 60c. | 2.00 |
|------|------|------|------|



BIG BOSTON LETTUCE.

COS OR ROMAINE LETTUCE.

Paris White Cos. (Trianon). This is considered the most reliable cos variety, grows upright, with long, spoon-shaped leaves, forms well-filled head of fine quality

| | | | |
|------|------|------|------|
| 10c. | 20c. | 55c. | 1.75 |
|------|------|------|------|

Musk Melon.

Cantaloupe—Melon Muscatel—Phone o Mellone.

Pkts. any variety Musk
Melon 10c. each.

Culture. Plant in the spring, in hills five or six feet apart each way, well manured with old rotten compost. Scatter a dozen seeds to the hill, and after they are out of danger from bugs, thin to three or four plants. A light, dry, sandy soil and a dry atmosphere are most suitable. Melons should not be planted near any other varieties if it is desired to preserve them pure.

GREEN-FLESHED VARIETIES.

Rocky Ford. Oval-shaped, nearly round, medium size, and thickly netted, with no trace of ribs. The flesh is green, and for sweetness and spiciness is unexcelled. However, salmon-fleshed selections have now almost entirely superseded it as a shipping melon for reasons of rust resistance and shipping qualities. Price per oz., 15c.; per ¼-lb., 40c.; per lb., \$1.25.

Hackensack or Nutmeg. An old standby which has prominent ribs; attains a large size, is late, round in shape, flattened at the ends, green flesh. Price per oz., 15c.; per ¼-lb., 40c.; per lb., \$1.25.

SALMON-FLESHED VARIETIES.

Bender's Surprise. A large, oval-shaped high-class melon with deep salmon flesh of most delicious flavor; keeps and ships remarkably well, in fact, actually improves after picking. Price per oz., 20c.; per ¼-lb., 55c.; per lb., \$1.75.

Extra Early Osage. This is a fine early melon of the Osage type, medium size, oval, slightly netted and richly flavored, with a spicy lusciousness peculiarly its own; flesh thick and firm, but when fully ripe dissolving and delectable. Price per oz., 20c.; per ¼-lb., 55c.; per lb., \$1.75.

Hale's Best. A new, extra early melon which originated in the Imperial Valley, California; an oval about 8x4½ inches, with heavy netting and fairly prominent ribs; salmon flesh of exceptional thickness. Hale's Best has become a most important early shipping sort. Price per oz., 20c.; per ¼-lb., 55c.; per lb., \$1.75.

Sugar Rock. A new, salmon-fleshed melon from Michigan where it has become very popular. It seems to combine quality and attractiveness, with great yield and shipping qualities. We advise that you give it a trial. Price per pkt., 10c.; per oz., 20c.; per ¼-lb., 55c.; per lb., \$1.75.

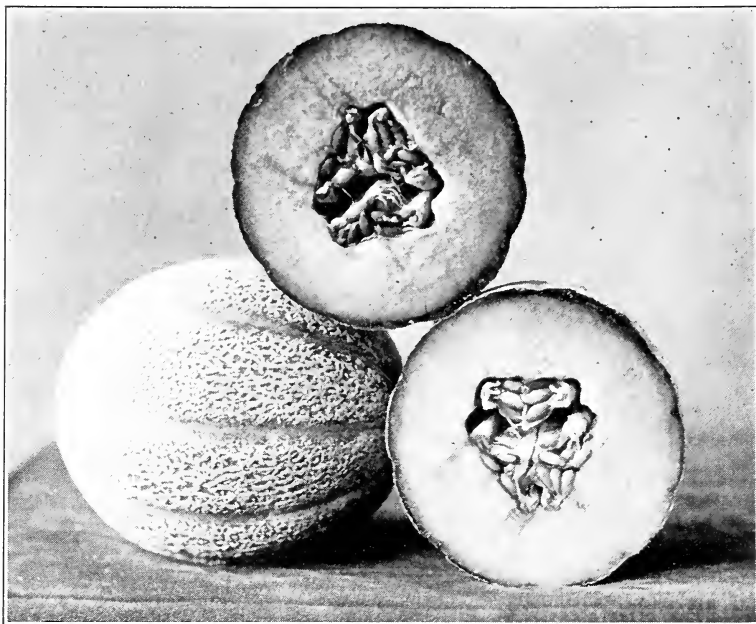

HALE'S BEST.

Milwaukee Market. A new melon very much like Bender's Surprise in size and appearance, though about a week later. The flesh is equally tender, thick and delicious. An exceptionally high quality melon for nearby market and home use. Per pkt., 10c.; oz., 20c.; ¼-lb., 55c.; lb., \$1.75.

New Pollock No. 10-25. The result of long-continued work in the famous Rocky Ford melon section to produce a salmon flesh "Rocky Ford," highly rust resistant. It is now the only melon grown to any great extent in that district. A rather late melon, nearly round, 5½x5 inches, heavily netted, no trace of ribs, flesh exceptionally thick. Price per oz., 15c.; per ¼-lb., 40c.; per lb., \$1.25.

Emerald Gem. Small but prolific. Has a thin green rind, which makes it unsuitable for shipping; a very small seed cavity, rich and luscious meat of a salmon color. Price per oz., 15c.; per ¼-lb., 40c.; per lb., \$1.25.

Osage or Miller's Cream. Smooth, or slightly netted, green exterior, medium size, oval slightly ribbed, thick, hard, salmon flesh; larger and about a week later than Early Osage; one of the finest melons grown. Per oz., 15c.; ¼-lb., 40c.; lb., \$1.25.

Tip Top. Very large, deeply ribbed, and thickly netted. Flesh yellow, thick and very sweet. Price per oz., 15c.; per ¼-lb., 40c.; per lb., \$1.25.

Martynia.

The seed pods are used to considerable extent for pickling, when gathered green and tender. Sow in the open ground in May, and transplant two feet apart.

Martynia Proboscidea. Price per pkt., 10c.; per oz., 50c.; per lb., \$5.00.

Water-Melon.

Wassermelone—Sandia—Anguria o Mellone.

Culture. Plant in hills six or eight feet apart, in May. Select warm, light, dry ground and in preparing the hills let them be dug out as broad and deep as the soil will admit; fill at least one-third full of the best decomposed stable manure, and mix thoroughly with the soil; fill up a little above the level of the ground.

Cole's Early. A striped variety, nearly round, medium size; excellent quality; seed black. Price per pkt., 10c.; per oz., 15c.; per ¼-lb., 35c.; per lb., \$1.00.

Monte Cristo or Kleckley's Sweets. Skin dark green, thin rind, flesh scarlet, very solid, firm and luscious; seed white. Price per pkt., 10c.; per oz., 15c.; per ¼-lb., 35c.; per lb., \$1.00.

Halbert's Honey. Large, oblong, dark green, medium early, very sweet, crimson flesh, white seeded, quality the best. Price per pkt., 10c.; per oz., 15c.; per ¼-lb., 35c.; per lb., \$1.00.

Ice Cream or Peerless. White seeded; early oblong; medium size; flesh sweet and tender; green skin, very thin rind. Price per pkt., 10c.; per oz., 15c.; per ¼-lb., 35c.; per lb., \$1.00.

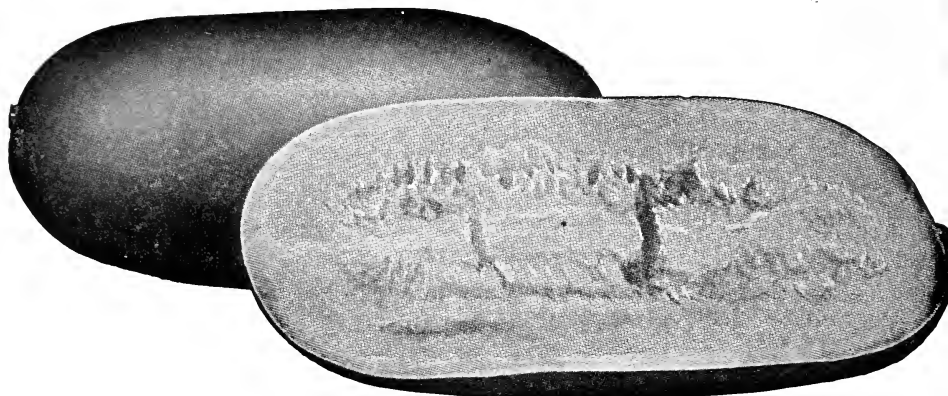

HALBERT'S HONEY WATERMELON.

Klondike. A new, early, high-quality, medium, sized melon for home or nearby market. While cylindrical in shape, the Klondike tapers toward the blossom end. Size about 10 x 16 inches; rind dark green; flesh deep red, free from fiber; in season about five days earlier than Halbert Honey. Price per pkt., 10c.; per oz., 15c.; per ¼-lb., 50c.; per lb., \$1.50.

Sweet Heart. A rather late, mottled light green; large, oval, black-seeded sort of excellent quality. Price per pkt., 10c.; per oz., 15c.; per ¼-lb., 35c.; per lb., \$1.00.

Tom Watson. A large, late, long dark green melon with bright red flesh, brown seed. Its tough rind makes a good shipper. Price per pkt., 10c.; per oz., 15c.; per ¼-lb., 35c.; per lb., \$1.00.

Citron.

Citron for Preserves and Sweetmeats. Round, striped, red seeds. Price per pkt., 10c.; per oz., 15c.; per ¼-lb., 35c.; per lb., \$1.00.

Colorado Preserving Citron. Oblong and very large. Price per pkt., 10c.; per oz., 15c.; per ¼-lb., 35c.; per lb., \$1.00.

Mushroom Spawn.

Blanc de Champignon—Seta—Champignonbrut

Mushroom Culture. Mushrooms are an edible fungus and may be grown wherever the temperature of fifty degrees can be kept up through the winter. The beds should be made from November to February, according to the time the mushrooms are wanted. It requires about two months for them to begin bearing.

American Pure Culture Spawn (bricks). Ten bricks will spawn 100 sq. ft. (10 x 10 ft.) One brick, 30c.; 10 bricks, \$2.50. Postage extra, 1¼ lbs. each.

Mustard.

Senf—Mostaza—Mortarda.

Sow in April, in drills a foot apart, and thin out moderately when about three inches high. For succession sow every three or four weeks.

Fordhook Fancy. Handsomely curled and fringed, dark-leaved, vigorous growing variety; mild and remaining a long time before going to seed. Fine for salads and garnishings. Price per pkt., 10c.; per oz., 15c.; per ¼-lb., 35c.; per lb., \$1.00.

Southern Giant Curled. A very hardy light green variety. Very popular, especially in the South during winter and early spring; excellent for salads. Price per pkt., 10c.; per oz., 15c.; per ¼-lb., 25c.; per lb., 75c.

White London. Used for salads or greens when young. Per pkt., 10c.; per oz., 15c.; per ¼-lb., 20c.; per lb., 60c.



MUSHROOMS.

Onions.

Zwiebel—Cebolla—Cipolla.

Onion seeds should be sown as early as it is possible to work the ground, in drills one inch deep and twelve to sixteen inches apart, in rich soil, deeply tilled and lightly rolled. Thin to one inch apart. When sowing for sets, seed must be put in very thick, at the rate of about twenty pounds to the acre. The same patch may be used year after year for onions and never made too rich.

Danvers Yellow Globe. Large, mild, nearly globe shaped, has small neck, ripens up uniformly and is a good keeper. Especially popular in Connecticut Valley. Price per pkt., 10c.; per oz., 25c.; per ¼-lb., 65c.; per lb., \$2.25.

Southport Yellow Globe. Deep globe-shaped and a heavy late cropper; one of the most extensively grown, for winter markets. Price per pkt., 10c.; per oz., 25c.; per ¼-lb., 75c.; per lb., \$2.50.

Yellow Dutch or Strasburg. Large and flat. A great yielder. Sown extensively for sets. Price per pkt., 10c.; per oz., 25c.; per ¼-lb., 65c.; per lb., \$2.25.

Prize Taker. Rich straw color, of enormous size. The flavor is mild and delicate. Price per pkt., 10c.; per oz., 25c.; per ¼-lb., 75c.; per lb., \$2.50.

Ailsa Craig. An English sort of the very largest, frequently five inches in diameter, weighing two pounds each. Skin straw color; flesh white, firm and mild. For exhibition sow in hot-bed and transplant. Price per pkt., 10c.; per oz., 35c.; per ¼-lb., \$1.00; per lb., \$3.50.

Extra Early Red. Ten days earlier than Large Red. Price per pkt., 10c.; per oz., 30c.; per ¼-lb., 85c.; per lb., \$3.00.

Large Red Wethersfield. A large flat variety, very productive, keeps well. Price per pkt., 10c.; per oz., 25c.; per ¼-lb., 65c.; per lb., \$2.25.

Southport Red Globe. This is a large, globe, deep red-skinned variety; very mild, best keeper. Per pkt., 10c.; per oz., 30c.; per ¼-lb., 80c.; per lb., \$2.75.

Southport White Globe. In form nearly ovoid, very regular and symmetrical; skin white, flesh fine grained snowy white, mild. Price per pkt., 10c.; per oz., 30c.; per ¼-lb., 80c.; per lb., \$2.75.

White Portugal or Silver Skin. Flat, very early, mild flavor. Price per pkt., 10c.; per oz., 30c.; per ¼-lb., 85c.; per lb., \$3.00.

Mammoth Silver King. Very large, white and flat. Price per pkt., 10c.; per oz., 30c.; per ¼-lb., 85c.; per lbs., \$3.00.

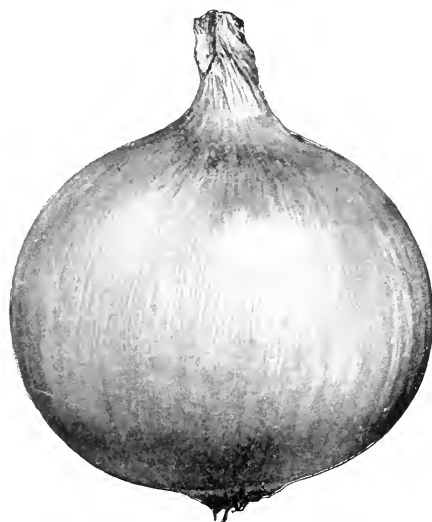

DANVERS YELLOW GLOBE.



EBENEZER ONIONS GROWN FROM SETS.

Onion Sets.

Onion sets, for both rare-ripes and tops, are set in twelve-inch drills, about three inches apart, and lightly covered. By this process early onions may be obtained several weeks earlier than from seed.

Ebenezer Onion Sets. (Yellow.) Much the best sort of yellow sets for earliness, quality and production. Few seed stalks is a valuable feature. Per qt., 30c.; per pk., \$1.50; per bu., \$4.75.

White Onion Sets. Per qt., 30c.; per pk., \$1.50; per bu., \$5.00.

Red Onion Sets. Per qt., 25c.; per pk., \$1.25; per bu., \$4.50.

Egyptian or Perennial Tree. Set out in July and August for early spring use. Per qt., 15c.; per pk., 85c.; per bu., \$3.00.

For sets in quantities, get special quotations, as prices vary during the season of planting.

Postage on Onion Sets extra, 1 lb. per qt.

Okra or Gumbo

Safran—Quimbombo—Othro.

Select warm, rich soil and plant in rows two feet apart, thinning plants to a foot apart in the row. The pods are used to thicken soups, being gathered young. Okra is preserved for winter use by slicing the pods into rings and drying them upon strings hung up and exposed to the air.

White Velvet. Pods round, smooth and free from seams. Price per pkt., 10c.; per oz., 15c.; per ¼-lb., 25c.; per lb., 75c.

Dwarf Green Prolific or Density. Early variety, pods green, slightly ridged and thickly set. Price per pkt., 10c.; per oz., 15c.; per ¼-lb., 25c.; per lb., 75c.



DWARF GREEN OKRA.

Parsley.

Petersilis—Perejil—Prezzemolo.

Parsley succeeds best in rich mellow soil. As the seeds germinate very slowly, three or four weeks elapsing before it makes its appearance, it should be sown

early in the spring. Sow thickly in rows a foot apart and half an inch deep. For winter use, protect in a frame or light cellar.

Champion Moss Curled. Very closely curled, dark green, the most popular. Price per pkt., 10c.; per oz., 15c.; per ¼-lb., 35c.; per lb., \$1.00.

Fern Leaf. A fine curled, fern-like variety. Price per pkt., 10c.; per oz., 15c., per ¼-lb., 50c.; per lb., \$1.50.

Plain Leaf. Leaves dark green, deeply cut but not curled, more flavor and hardier than the curled variety. Price per pkt., 10c.; per oz., 15c.; per ¼-lb., 35c.; per lb., \$1.00.

Hamburg Large-Rooted. The root is the edible portion. This is white; resembles a small parsnip. Price per pkt., 10c.; per oz., 15c.; per ¼-lb., 35c.; per lb., \$1.00.



MOSS CURLED PARSLEY.

Parsnips.

Partinake—Chirivia—Pastainaca.

Sow as early in spring as the weather will permit, in drills fifteen inches apart, covering lightly. When well up, thin out to five or six inches apart in the rows. They are improved by frost, and it is a good plan to take up in the fall a certain quantity for winter use, leaving the rest in the ground until spring, to be dug up as required. They should be more extensively grown for stock feeding, being more nutritious than turnips, and an immense cropper.

Half Long Thick Shoulder. This is an intermediate. Wide at the top. Price per pkt., 10c.; per oz., 15c.; per ¼-lb., 35c.; per lb., \$1.00.

Hollow Crowned. Broad shoulder, medium long. The Hollow Crowns are considered superior to other kinds, and our stock of this is especially fine. Price per pkt., 10c.; per oz., 15c.; per ¼-lb., 35c.; per lb., \$1.00.

Long White Smooth or Sugar. Large and quite long, free from side root; sweet and excellent flavor. Price per pkt., 10c.; per oz., 15c.; per ¼-lb., 35c.; per lb., \$1.00.



HOLLOW CROWNED PARSNIP.

Peas.

Erbesen—Ginsante—Pisrelli.

Culture. Peas, for an early crop, should be sown as soon as the ground is in working condition. Soil should be light and dry. For general crops the ground should be well manured the previous year. They are usually planted in double rows three or four inches apart, and covered to the depth of two and one-half to three inches. All wrinkled peas are superior and more delicate in flavor than those that present a full and perfect form; like sugar corn, the saccharine matter which they contain causes them to shrivel when dried, and they will remain much longer in season than the other kinds.

Earliest Peas.

Pkts. any variety Peas 15c. each
except where noted.

Two or Three Feet High.

Alaska, or Earliest of All. The earliest pea in cultivation, very hardy, seed small, round, bluish green, vines 2½ to 3½ feet high, pods 2½ inches long, 4 to 6 peas in a pod. The crop matures evenly, mostly gathered in one picking. Price per pt., 30c.; per qt., 50c.; 10 lbs., \$1.80; 100 lbs., \$15.00.

Pedigree Extra Early. This is the finest strain of extra earlys, only about two days later than Alaska; pods averaging slightly larger, vines 2½ to 3 feet high, dry seed, white or manilla color, considered better quality than Alaska. Price per pt., 30c.; per qt., 50c.; 10 lbs., \$1.90; 100 lbs., \$16.00.

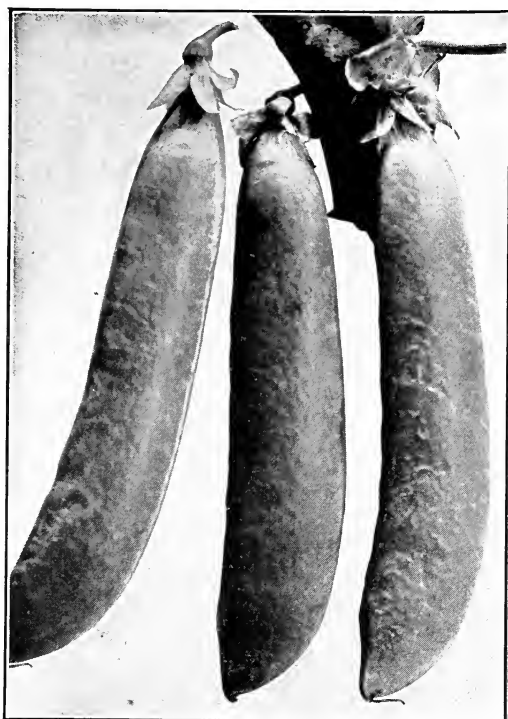

GRADUS PEAS.
WORLD'S RECORD STRAIN.

Gradus. World's Record Strain. The earliest large-podded pea in cultivation. Vine about three feet, light green. Pods dark green, four inches long, peas extra size and delicious flavor. Price per pt., 30c.; per qt., 55c.; 10 lbs., \$2.10; 100 lbs., \$18.00.

Thomas Laxton. Resembles Gradus somewhat in habit and rapidity of growth, earliness and luxuriance of foliage though darker and more productive, possibly three days later. Pods large, blunt ended, well filled, quality unsurpassed, seed wrinkled, cream color, tinged with green. Height three feet. Price per pkt., 30c.; per qt., 55c.; 10 lbs \$2.10; 100 lbs., \$18.00.

Peas, Dwarf.

Little Marvel. Resembles Nott's Excelsior, though larger in vine and growth, ordinarily fifteen to twenty inches high, pods borne in pairs, three inches long, very tightly filled. Price per pt., 30c.; per qt., 55c.; 10 lbs., \$2.10; 100 lbs., \$18.00.

Laxtonian. A dwarf pea (eighteen inches) with large, dark green pods four inches long. Matures about the same time as Gradus. A fine pea of superb quality for either private or market gardeners. Blue Bantam and Hundredfold belong to the same group, which is the highest quality class of dwarf peas. Our stock of this pea is especially fine. Price per pt., 30c.; per qt., 55c.; 10 lbs., \$2.10; 100 lbs., \$18.00.



LAXTONIAN PEAS.

Note—Not less than 5 pounds at the 10-pound rate or less than 25 pounds at the 100-pound rate. Postage extra in Peas, Beans and Sweet Corn, except in pkts. Peas and Beans weigh about 2 lbs. per qt.; Sweet Corn 1½ lbs. Add for postage according to zone (see page 2).

Peas—Continued.

Pkts. any variety Peas 15c. each
except where noted.

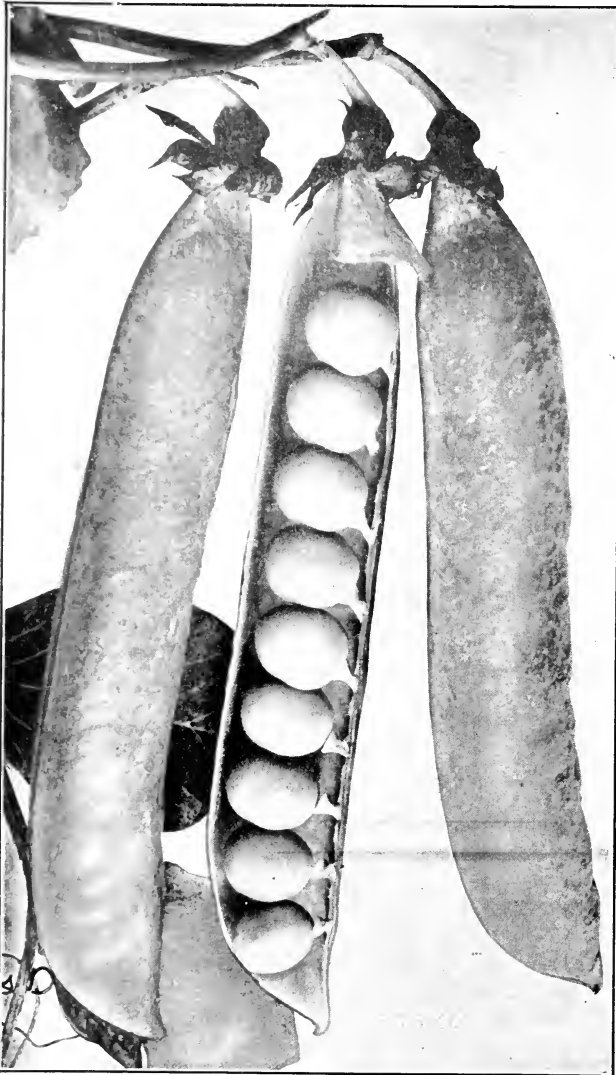

TELEPHONE PEAS.

yield abundantly. Pods $4\frac{1}{4}$ inches long and broad, filled with peas of corresponding size. Price per pt., 30c.; per qt., 55c.; per 10 lbs., \$2.00; per 100 lbs., \$17.00.

NOTE REGARDING OLD VARIETIES OF PEAS. We have discontinued several of the old varieties, such as Champion of England, Duke of Albany, White and Black-Eyed Morrowfat, Stratagem, Bliss Evergreen Little Gem and other antiquated varieties still being called for. We recommend that you use the newer and better sorts. In Connecticut, for the past several years, early sorts have done better than late, for they are through before hot weather arrives. Peas do not thrive in hot weather.

EDIBLE PODDED PEAS.

Melting Sugar. Bears fleshy edible pods from four to five inches long and an inch wide. Very tender when young; cooked much the same as snap beans. The vines grow five feet long and require support. Price per pt., 40c.; per qt., 70c.; 10 lbs., \$3.00; 100 lbs., \$27.00.

PEAS FOR SOWING BROADCAST.

Canada Field. For field culture only. In their dry state they are used for feeding stock, making soups, etc. They are usually sown broadcast and often with oats or barley, cut and fed green, or left to ripen and then threshed. Price per qt., 25c.; 10 lbs., \$1.00; 100 lbs., \$7.00.

Laxton's Progress. A new pea of the Laxtonian type, four days earlier, eighteen inches high, with deep green, broad pods four inches long, averaging eight, one more pea to the pod. It is of highest quality and productive. Price per pkt., 15c.; per pt., 30c.; qt., 55c.; 10 lbs., \$2.10; 100 lbs., \$18.00.

Sutton's Excelsior. Large seeded, dwarf, early, wrinkled pea. Pods long, broad, straight, pale green vines. Price per pt., 30c.; per qt., 55c.; 10 lbs., \$2.10; 100 lbs., \$18.00.

American Wonder. One of the old sorts. very dwarf, growing but ten to fifteen inches high; pods two and three-quarters inches long. Price per pt., 30c.; per qt., 55c.; 10 lbs., \$2.10; 100 lbs., \$18.00.

Nott's Excelsior. Early sort of the American Wonder and Little Gem type, very dwarf, twelve to fifteen inches high, pods medium size, blunt ended $2\frac{3}{4}$ inches long, tightly filled with 6 to 8 peas of high quality. Price per pt., 30c.; per qt., 55c.; 10 lbs., \$2.10; 100 lbs., \$18.00.

General and Late Crop.

Two and one-half to Five Feet High.

Onward. (New.) A distinct, heavy-cropping, mid-season, dwarf variety with strong, medium-green foliage. The large, blunt pods are tightly filled with peas of good quality. Height 2 to $2\frac{1}{2}$ feet. pods 4 inches. Price per pt., 30c.; per qt., 55c.; 10 lbs., \$2.10; 100 lbs., \$18.00.

Telephone. Extra fine, large, dark green pods, $4\frac{1}{2}$ inches long, of highest quality. Vine, four feet. The standard for late crop. Various strains of Telephone Peas differ greatly. For appearance of pods, flavor and productiveness, our stock is equal to the best. Price per pt., 30c.; per qt., 55c.; 10 lbs., \$2.00; 100 lbs., \$17.00.

Alderman. A tall-growing late variety of the large, broad-podded, dark green type, very prolific. Price per pt., 30c.; per qt., 55c.; 10 lbs., \$2.00; 100 lbs., \$17.00.

Prince Edward. Height four feet. One of the largest podded peas. Vines make a rank growth under good cultivation and

Peas belong to the legume family, and can be inoculated with Cultures, enabling them to improve the soil supply of nitrogen. This should be taken advantage of, especially in large plantings. See page 37.

Peppers.

Pkts. any variety Peppers
10c. each
except where noted.

Pfeffer—Pimiento—Peperone.

Peppers should be started under glass. Transplant into the open ground towards the close of May, having the rows eighteen inches apart; plant a foot apart in the rows. The ground should be made very rich, either by high manuring before the plants are transplanted, or by the liberal application of guano or liquid manure afterwards.

Harris' Earliest. A very prolific pepper, of medium size, extremely early, earlier than Neapolitan, of the Ruby King form. Fruits three and one-half inches high by two and one-half inches in diameter; three lobed and sweet. Plants small and compact. Per pkt., 10c.; oz., 60c.; ¼-lb., \$1.75; lb., \$6.00.

Early Giant. A new, valuable, very early pepper; earlier and more productive than any other large-fruited variety. The sweet thick-fleshed fruits average 5 inches long by 3½ inches in diameter. The plant is sturdy and compact, 24 inches tall. It is the greatest development in peppers in many years and is bound to supersede many of the older varieties, both for home and commercial use. Price per pkt., 10c.; per oz., 50c.; per ¼-lb., \$1.35; per lb., \$5.00.

Neapolitan. Very early; large slightly tapered, sweet thick flesh, productive. Price per oz., 40c.; per ¼-lb., \$1.00; per lb., \$3.75.

Ruby King. Very mild; the peppers attain large size. When ripe they are bright ruby red. A few days earlier than Ruby Giant and one of the most extensively grown for market. Price per oz., 35c.; per ¼-lb., \$1.00; per lb., \$3.50.

Ruby Giant or Worldbeater. A cross of the Chinese Giant and Ruby King. A very large, sweet mango pepper. Ideal shape, thick flesh and more prolific than Chinese Giant. Price per oz., 40c.; per ¼-lb., \$1.10; per lb., \$4.00.

California Wonder. A pepper with exceptionally heavy walls, heavier than any other sort. A most attractive pepper resembling Ruby Giant in size and season. Bright green changing to brilliant crimson; the flesh is sweet. Per pkt., 10c.; per oz., 60c.; ¼-lb., \$1.75; lb., \$6.00.

Large Bell or Bull Nose. (Hot Strain). An early variety, fruit three to five inches long, flesh thick and pungent. Price per oz., 40c., ¼-lb., \$1.10; per lb., \$4.00.

Chinese Giant. One of the largest. It is the square-shouldered type, thick, sweet flesh. Price per oz., 65c.; per ¼-lb., \$1.85; per lb., \$6.50.

Sunnybrook. An improved squash or tomato-shaped pepper, twice the size of the old sort, one of the very thick walled pappers. Fruits 3 to 3½ inches diameter by 2½ to 3 inches deep. Absolutely sweet. Per oz., 45c.; ¼-lb., \$1.25; lb., \$4.50.

Red Cherry. (Large) A small round variety of dwarf growth, very piquant and quite ornamental. Per oz., 60c.; per ¼-lb., \$1.50.

Mammoth Cayenne. (Anheim Chili). Fruit hot, bright red, five to six inches long by one thick at the stem and tapering to a point. Price per oz., 60c.; per ¼-lb., \$1.50.

Tabasco. The hottest of peppers, small bright red when ripe. Price per oz., 60c.; per ¼-lb., \$1.50.

Small Chili. Very piquant and prolific. Price per oz., 60c.; per ¼-lb., \$1.50.

Red Cluster. Small thin peppers of a coral red color; very hot and pungent. Price per oz., 60c.; per ¼-lb., \$1.50.

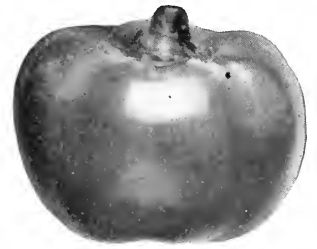

SUNNYBROOK PEPPER.



RUBY GIANT PEPPER.



RED CLUSTER.



IRIS COBBLER POTATOES.

Potatoes.

As prices of potatoes fluctuate according to supply and demand, it is impossible to make prices for seed stock that will hold throughout the planting season. Catalogue goes to press in December. Quotations will be given on application. All our seed stock is northern grown by specialists and sold at very close prices. Orders booked in advance are usually lowest.

Irish Cobbler. A very prolific, early, round, white. We have arranged for a supply of certified seed stock of this popular sort.

Potatoes—Continued.

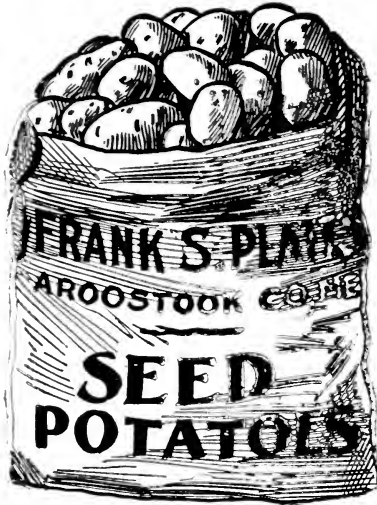

- New Queen.** Early, oblong, light pink.
- Early Norther.** Large size, oblong, light pink.
- Early Rose.** True stock, grown in Maine.
- Gold Coin.** Large, oval, cream white, second early and good for main crop.
- Delaware.** Large, white, and late.
- Spaulding Rose.** Large, oval, pink skin.
- Green Mountain.** Vines strong and vigorous; tubers white, smooth and medium large. Will have a supply of certified seed stock of this staple variety, also stock grown from certified seed at about 20c. per bushel less.
- Note.** The Irish Cobbler for early and Green Mountain for late crop are now more extensively used than any other sorts. Consequently have received more attention in building up high-yielding quality strains. We can recommend them strongly.

Pumpkin.

Pkts. any variety
Pumpkin 10c. each

Kurbiss—Calabaza—Zucca.

Plant about the middle of spring in manured hills eight feet apart, and leave but two or three plants in a hill; or plant in spring with Indian corn. Avoid planting near other vines.

Sugar. (New England Pie). Small, orange-colored, sweet and fine grained, finest quality. Price per oz., 15c.; per ¼-lb., 35c.; per lb., \$1.00.

Winter Luxury. Medium size, round, russet yellow, netted skin, excellent keeper, high quality. Price per oz. 15c.; per ¼-lb., 35c.; per lb., \$1.00.



SUGAR PUMPKIN.

Large Cheese
Cheese shape, creamy yellow color, flesh fine grained. Per oz., 15c.; per ¼-lb. 35c.; per lb., \$1.00.



LARGE CHEESE.

Connecticut Field. Large, round, orange yellow. A productive sort, principally for feed; not equal in quality to Large Cheese or Winter Luxury for pies. Price per oz., 15c.; per ¼-lb., 35c.; per lb., \$1.00.

Winter Crookneck or Cashaw. A large two-foot-long, fine grained class of pumpkins, equally good for cooking (especially for pies) as well as stock feeding. The long neck is always solid; is very prolific and a good keeper. The white or cream color are the favorite. Price per oz., 15c.; per ¼-lb., 40c.; per lb., \$1.25.

Large Tours or Mammoth. A very large, productive variety. Price per oz., 15c.; per ¼-lb., 40c.; per lb., \$1.25.

King of Mammoths, Jumbo or Potiron. One of the largest pumpkins; slightly ribbed, skin salmon-orange, flesh bright yellow. Price per oz., 15c.; per ¼-lb., 50c.; per lb., \$1.50.

Radish.

Rettig—Rabanos—Ravanello.

Sow early varieties in the spring as early as the ground can be worked, in drills ten inches apart, covering the seed half an inch deep; thin the plants to an inch apart in the row, as they are more tender and succulent when grown quickly. A rich, moist, sandy soil should be selected, and frequently watered in dry weather. For a succession, sow every two weeks until midsummer.

Saxa Extra Early. Special strain for under glass. The earliest forcing sort; ready in eighteen to twenty days. Bright red, globe-shaped, small leaved; select stock. Does well outside for very early planting. Price per pkt., 10c.; per oz., 15c.; per ½-lb., 40c.; per lb., \$1.25.

Radish—Continued. Pkts. any variety
Radishes 10c. each

Early Scarlet Globe. A splendid early radish either for forcing or outdoor; globe shaped, bright cardinal color, flesh white and remaining crisp for a long period, tops small; its fine appearance and quality have made it the most popular bunching sort. Price per oz., 15c.; per ¼-lb., 35c.; per lb., \$1.00.

Early Scarlet Turnip (White Tipped). Early, fine grain and flavor, round with white tip. Price per oz., 15c.; per ¼-lb., 25c.; per lb., 90c.

Early Scarlet Turnip. Small, round, mild and crisp. Price per oz., 15c.; per ¼-lb., 25c.; per lb., 90c.

Olive-Shaped Scarlet. Very early, oval in shape. Price per oz., 15c.; per ¼-lb., 25c.; per lb., 90c.

French Breakfast. A quick-growing, oval-shaped radish, light color and white tip. Price per oz., 15c.; per ¼-lb., 25c.; per lb., 90c.

Early Long Scarlet Short Top. Bright red color, very small tops. Price per oz., 15c.; per ¼-lb., 25c.; per lb., 90c.

Chartier or Shepherd. An early summer, half-long variety; deep pink, white at the tip. Price per oz., 15c.; per ¼-lb., 25c.; per lb., 90c.

Olive-Shaped White Forcing (Earliest White). Very mild and fine for forcing or outside planting. Price per oz., 15c.; per ¼-lb., 35c.; per lb., \$1.00.

White Icicle. The roots grow about four inches long and are ready for use within twenty-two days from the time of sowing. Price per oz., 15c.; per ¼-lb., 35c.; per lb., \$1.00.

White Summer Turnip. Round, pure white. Price per oz., 15c.; per ¼-lb., 35c.; per lb., \$1.00.

Stuttgart. A large round, white, solid variety for summer use, but keeping well into fall or winter. Price per oz., 15c.; per ¼-lb., 25c.; per lb., 90c.

White Strasburg. Five inches long, thick at shoulder, tapering abruptly, pure white, firm and brittle; grows to large size. Price per oz., 15c.; per ¼-lb., 25c.; per lb., 90c.

Mixed Radish Seed.

This is a mixture of the different varieties. It is prepared for those who want some of several kinds, but not a full planting of any one variety. As they mature irregularly the plantings may be less frequent.

Round and Olive. Price per oz., 15c.; per ¼-lb., 25c.; per lb., 85c.

Long. Price per oz., 15c.; per ¼-lb., 25c.; per lb., 85c.

Winter. Price per oz., 15c.; per ¼-lb., 25c.; per lb., 85c.

Pkts. any variety Radish 10c. each.



SCARLET GLOBE RADISHES.



OLIVE-SHAPED SCARLET RADISH.



ICICLE RADISH.

Winter Radishes.

Black Spinach (Round). For winter use; texture firm and solid. Price per oz., 15c.; per ¼-lb., 35c.; per lb., \$1.00.

Black Spanish (Long). Like the above, differing only in shape. Price per oz., 15c.; per ¼-lb., 35c.; per lb., \$1.00.

China Rose or Winter. Very fine for winter use; large and tender. Price per oz., 15c.; per ¼-lb., 35c.; per lb., \$1.00.

White China or Celestial. A winter sort, grows six to eight inches long, 2½ to 3 inches in diameter, and keeps well. Price per oz., 15c.; per ¼-lb., 35c.; per lb., \$1.00.

Rape--English.

Forage plants of great value. Its fattening properties about twice that of first-class clover. Of rapid and luxuriant growth, attaining a height of two or three feet. It may be sown throughout the season, and in a few weeks from sowing, stock can be turned in on it. For broadcasting, sow ten pounds to the acre; in drills, five pounds.

Dwarf Essex. Used also for greens and salad. Price per lb., 25c.; per 10 lbs., \$2.00; per 100 lbs., \$18.00.

Rhubarb or Pie Plant.

Rhubarb, familiarly known as Pie Plant, or Wine Plant, is cultivated in gardens for its leaf stalks. Rhubarb succeeds best in deep, somewhat retentive soil, and the richer this is, the better. Sow in drills an inch deep, and thin out the plants to six inches apart. In the fall, or spring, transplant into very highly manured soil, setting them three feet apart each way, and giving a dressing of coarse manure every fall. The stalks should not be gathered until the second year.

Myatt's Victoria. Price per pkt., 10c.; per oz., 15c.; per ¼-lb., 50c.; per lb., \$1.50.

Salsify or Oyster Plant.

Sow in early spring, in light, rich soil, in drills fourteen inches apart; thin the plants to three inches in the row. The roots will be ready for use in October; and, like the parsnip, improve by remaining in the ground through the winter.

Mammoth Sandwich Island. Roots grow long, smooth and white. Price per pkt., 10c.; per oz., 25c.; per ¼-lb., 75c.; per lb., \$2.50.

Long White French. Large, smooth and white. Price per pkt., 10c.; per oz., 25c.; per ¼-lb., 75c.; per lb., \$2.50.

Sorrel.

Sow early in spring in drills. It is perennial and runs quickly to seed unless kept cut close.

Large French. Price per pkt., 10c.; per oz., 20c.; per ¼-lb., 55c.; per lb., \$1.75.

Spinach.

The introduction of new types of Spinach recently makes it possible not only to grow heavier crops of better quality, but these types are slower to run up seed stalks. During the extra 12 to 14 days the plant makes more and larger foliage growth. We recommend using different varieties during the season, according to their hardiness and warm weather tolerance, about as follows: Early spring, Re-selected Savoy; late spring, Savoy Long Standing. Juliana stands more hot weather than any other. Late August to early September, Savoy Long Standing; September, Virginia Yellows Resistant where necessary because of yellows, otherwise Re-selected Savoy; fall to winter over, Re-selected Savoy or Giant Thick Leaf.



NEW ZEALAND SPINACH.

SALSIFY
OR OYSTER PLANT.



RESELECTED NORFOLK SAVOY SPINACH.

Spinach—Continued.

Giant Thick Leaved Longstanding. (New). Grows as quickly as the other early, smooth-leaved varieties, but is far superior to them because it stands up much longer. The leaves are very large, broad and thick. This sort is sold by some under the name of Nobel Spinach. Per pkt., 10c.; per ¼-lb., 15c.; per lb., 45c.

Norfolk Savoy Leaved. Reselected. (Bloomsdale). A handsome, very early, productive and hardy crumple-leaved, dark green. It is the standard sort for fall sowing and to winter over. Also for early spring seeding, but not later, on account of its running to seed quickly in warm weather. Per pkt., 10c.; ¼-lb., 15c.; lb., 45c.

Savoy Long Standing. A valuable selection from Savoy to eliminate the plants which bolt to seed early. This strain will stand from seven to ten days longer than the regular and produces a heavy crop of handsome appearance. Price per pkt., 10c.; ¼-lb., 15c.; lb., 45c.

Virginia Savoy Spinach. A yellows-resistant strain of interesting history brought about by the crossing with a Manchurian sort. The Virginia Truck Experiment Station is continuing its work, with constant improvement in the

type. It is, therefore, important to secure seed, as we offer only one generation removed from the stock seed. Spinach yellows has been a serious trouble in New England. This type is unsuitable for use except during the fall months for fall cutting. Price per pkt., 10c.; per ¼-lb., 15c.; per lb., 45c.

King of Denmark Spinach. A spinach for late spring sowing; the plants are slow to run to seed. The leaves are large, round, dark green and crumpled or savoyed. Per pkt., 10c.; per ¼-lb., 15c.; per lb., 45c.

Princess Juliana. This new spinach is compact, having a very short petiole (leaf stem), extremely dark green leaf of heavy substance and crumpled. It is a slow grower, being fully ten days later than King of Denmark, which makes it valuable for late spring and early summer use, when other sorts would bolt to seed. Price per pkt., 10c.; per ¼-lb., 15c.; per lb., 45c.

New Zealand. A branching plant of thick, fleshy, succulent growth. It is not strictly of the spinach family. Used same as spinach; flourishes under the heat of summer, and continues growing vigorously in most any kind of soil until killed by frost. The young branches are cut off as required. Price per pkt., 10c.; per ¼-lb., 25c.; per lb., 75c.

Note. Market growers' special prices on spinach in 100-lb. lots and over quoted on application.

Squash.

Speise Kurbis—Calabaza—Zucca.

Pkts. any variety Squash
10c. each

The squash is a very tender vine and so sensitive that it cannot be planted out with safety until the weather becomes warm and settled. Plant in hills ten feet apart for running varieties; five feet for bush sorts; working some fine rich manure into each hill. Sprinkle liberally with plaster, wood ashes, or air-slacked lime, in the early stages of growth. Cultivate until runners are well started.

Yellow Bush Scallop Summer. One of the earliest; grows flat, with scalloped edges. Price per oz., 15c.; per ¼-lb., 35c.; per lb., \$1.00.

White Bush Scallop. Like the above in everything except color, which is creamy white. Price per oz., 15c.; per ¼-lb., 35c.; per lb., \$1.00.

Early Summer Crookneck Bush. Early and productive; moderately warted golden yellow, 12 to 14 inches long. Per oz., 15c.; per ¼-lb., 40c.; per lb., \$1.25.

Giant Crookneck. (Summer). Early yellow and warted; rapid growing; attains large size, average 16 to 20 inches. Per oz., 15c.; per ¼-lb., 40c.; per lb., \$1.25.

Giant Straightneck. A selection from Crookneck. Per pkt., 10c.; per oz., 20c.; per ¼-lb., 55c.; per lb., \$1.75.

Fordhook Bush. Eight to ten inches long, cream color outside and straw yellow within. For summer and fall use, very dry and sweet. Price per oz., 15c.; per ¼-lb., 40c.; per lb., \$1.25.

Delicious. Fall or winter sort of medium size, 6 to 10 lbs. each, top shaped dark green shell, flesh thick bright yellow, dry and sweet. Per oz., 15c.; per ¼-lb., 40c.; per lb., \$1.25.

Hubbard. Dark green, hard-shelled variety; flesh fine grained, dry and of good flavor. Per oz., 15c.; per ¼-lb., 40c.; per lb., \$1.25.

Warted Hubbard. Similar in shape and color to the original Hubbard Squash, but larger fruits, with hard, roughly warted surface. Quality of flesh is equal to any of its class. Per oz. 15c.; per ¼-lb., 40c.; per lb., \$1.25.

Golden Hubbard. In color a bright deep orange yellow. Flesh golden yellow and fine grain, excellent flavor. Per oz., 15c.; per ¼-lb., 40c.; per lb., \$1.25

Boston Marrow. A superior fall squash, of rich orange color, and very productive. Per oz., 15c.; ¼-lb., 35c.; lb., \$1.00.

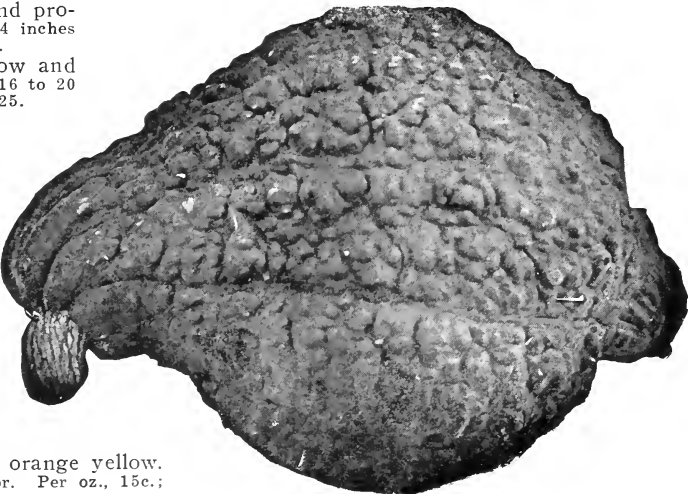

WARTED HUBBARD.

Squash—Continued. VEGETABLE MARROWS.

English. Very prolific; smooth, cream colored skin; maturing between the early summer and winter sorts. The fruits are best for the table when young or half matured. Price per pkt., 10c.; per oz., 15c.; per ¼-lb., 40c.; per lb., \$1.35.

Italian (Cocozelle Long Green Bush). Grows from ten to twenty inches long; diameter about four inches; skin smooth, dark green color, marbled yellow or pale green. Per pkt., 10c.; per oz., 15c.; per ¼-lb., 50c.; per lb., \$1.50.

Italian Cocozelle Longe. This is a favorite Italian Marrow and generally allowed to run over brush supports or fences. It is quite ornamental, when trained over the pergola or arbor, furnishing both shade and edible fruits; cream color, two to three feet long and three to four inches in diameter. Per pkt., 10c.; per oz., 30c.; per ¼-lb., 85c.; per lb., \$3.00.

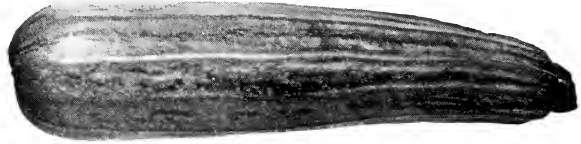

COCOZELLE LONG GREEN BUSH.

Tobacco.

Sow the seed in frames the latter part of March, or in the open ground when the soil has become settled and warm. Keep well watered, and when the plants are two inches high they may be transplanted in rows three feet apart each way. Tobacco requires a very rich, light, mellow soil.

Connecticut Seed Leaf. The popular variety in this vicinity, produces a very heavy crop of the fine broad leaves, mostly used for cigar wrappers. Per pkt., 10c.; per oz., 40c.; per ¼-lb., \$1.10; per lb., \$4.00.

Havana. An excellent variety; leaves narrow, long and pointed. Price per pkt., 10c.; per oz., 40c.; per ¼-lb., \$1.10; per lb., \$4.00.

Tomato.

Liebesapfel—Tomatoes—Pomodoro.

Pkts. any variety Tomato 10c.
each, except where noted

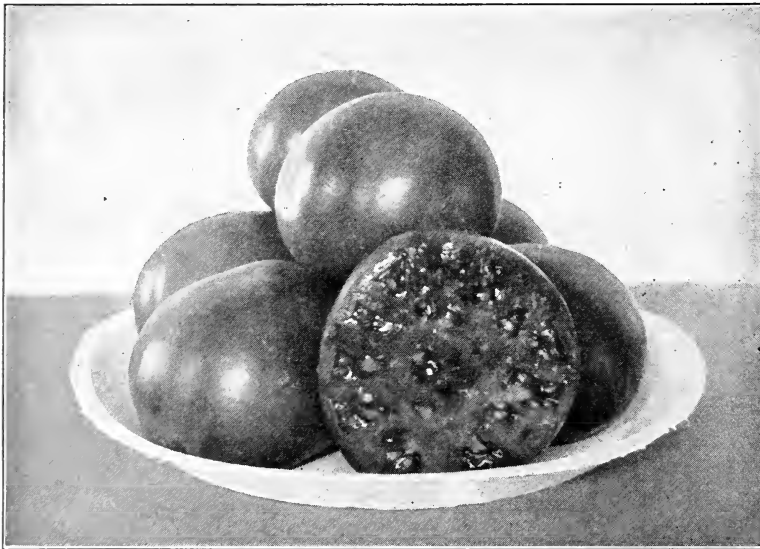

SPECIAL EARLIANA.

To obtain fruit very early, sow the seeds in greenhouse during February or March, or in hotbed when season has sufficiently advanced. In about five weeks plants should be transplanted to another hotbed, until about the middle of May, when they may be put into the ground in hills, about four feet apart each way. The richer the soil the ranker will be the growth of the vines, but an ordinary warm, light soil, with fine, well-rotted manure in the hill, and a sunny location, will produce the more handsome and plentiful fruit.

Earliana. The most extensively grown extra early. Fruits medium in size, bright red. Vines usually through bearing or dead by September first. The most important feature of Earliana is its extreme earliness, with as firm smooth fruits as can be had,

without sacrificing this feature. The seed we offer is a fine strain. It has been produced with care to combine these features to a remarkable extent. Price per oz., 35c.; per ¼-lb., \$1.00; per lb., \$3.50.

Earliana Special. A strain we have a very limited amount of, on which has been spent much time in individual plant selection, resulting in greater uniformity, smoothness and productiveness than in any other strain we have ever seen. It is undoubtedly profitable for market growers to use such seed when obtainable. Price per pkt., 15c.; per oz., 75c.; per ¼-lb., \$2.00; per lb., \$7.50.

Pritchard. (New) A great advance in the early class. First fruits ripen with Earliana and considerably ahead of Bonny Best. A cross between Marglobe and Cooper's Special by the late Dr. F. J. Pritchard. Fruits good size, intense scarlet and do not turn yellow or blister; similar in structure to Marglobe, solid, almost no core, small seed pockets; excellent in appearance and quality. The plants produced an unusually heavy crop the past season. We believe the Pritchard will prove valuable for both market and home use. Price per pkt., 15c.; per oz., \$1.50.

Bonny Best. An early, round, smooth, bright scarlet Tomato, similar to Chalk's Early Jewel; about a week earlier and slightly smaller, producing especially well the early clusters of 3 to 5 attractive, solid fruits. Price per oz., 40c.; per ¼-lb., \$1.00; per lb., \$3.75.

Tomato—Continued.

Pkts. any variety Tomato
10c. each, except where noted

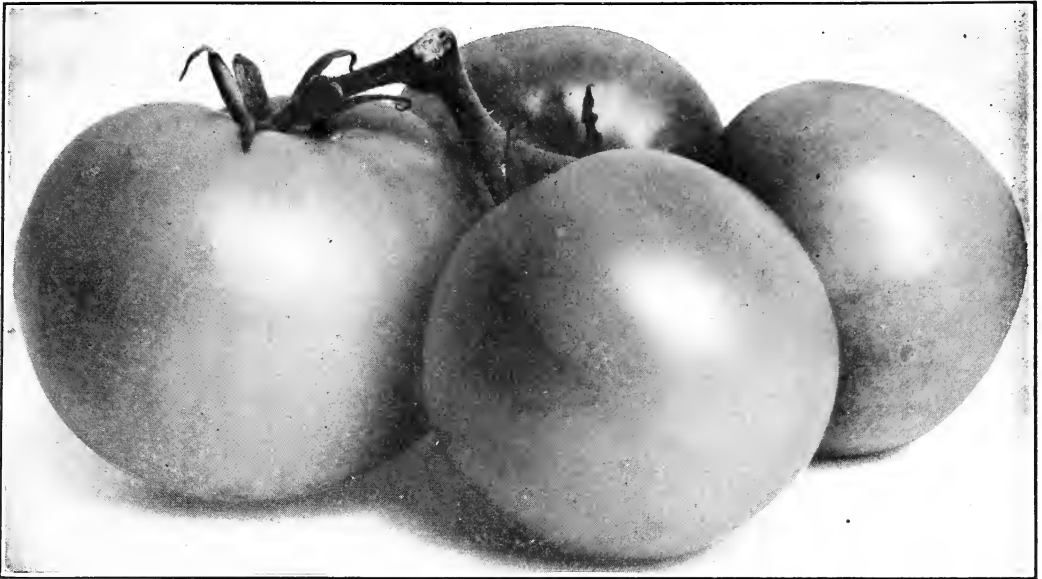

A SELECT STOCK OF CHALK'S EARLY JEWEL TOMATO.

Chalk's Early Jewel. Medium size, bright red, smooth and solid; vines vigorous and heavy cropper, production continues over a long season, the best all-around second early. For many years a system of plant selection has been carried out in the growing of our tomato seed that has resulted in remarkably fine strains. The Chalk's Early Jewel has received particularly rigid selection. You will find this stock exceptionally fine. Price per oz., 40c.; per ¼-lb., \$1.00; per lb., \$3.75.

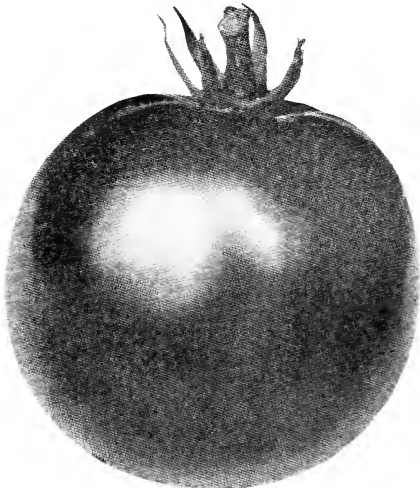

MARGLOBE.

John Bear. An excellent quality; firm, good-sized, smooth, scarlet fruited tomato. A selection from Chalk's Early Jewel; exceptionally productive and one of the best second early or main crop tomatoes for market and canning. Price per oz., 40c.; per ¼-lb., \$1.00; per lb., \$3.75.

Dwarf Champion. Plant of compact, upright growth, fruits in clusters of 3 to 5; smooth, solid, medium-sized, pink-fruited, ripening with the second earlies and main crop sorts. Price per oz., 40c.; per ¼-lb., \$1.0; per lb., \$4.00.

Marglobe. A disease-resistant variety introduced by the U. S. Department of Agriculture. Globe shaped, bright scarlet inside and out, very solid, almost coreless and productive; in season about 5 days' earlier than Stone. Price per pkt., 10c.; per oz., 50c.; per ¼-lb., \$1.35; per lb., \$5.00.

Improved Stone. Large, bright, scarlet, very smooth, ripening evenly; solid and firm. This most important main crop variety has received the same rigid selection that has been carried out on our Chalk's Early Jewel, with the result of making it the finest stock we know of, notwithstanding many so-called new sorts, for which great claims are made. It is about 10 days earlier than the old strain. Price per oz., 35c.; per ¼-lb., \$1.00; per lb., \$3.50.

Oxheart. A very large, late, pink-fruited tomato. It is oxheart in shape, heavy and solid, setting in clusters of 3 to 7, has few seeds and excellent quality. A novelty in size, and shape but not a market variety. Price per pkt., 15c.; per oz., \$1.00.

Ponderosa. This excels in size, weight and solidity. Its color is purplish pink, and almost seedless. Price per oz., 55c.; per ¼-lb., \$1.50; per lb., \$5.50.

Golden Queen. A yellow sort of first quality. Solid, very smooth, large and ripens early. Price per oz., 50c.; per ¼-lb., \$1.35; per lb., \$5.00.

Yellow Pear. Pear shaped and used for pickling or preserving. Price per oz., 55c.; per ¼-lb., \$1.50; per lb., \$5.50.

Red Plum. Similar to the Pear, except in shape, which is full at top instead of tapering, and used for the same purposes. Price per oz., 55c.; per ¼-lb., \$1.50; per lb., \$5.50.

Red Cherry. A small, round, red tomato; size and shape like a cherry. Price per oz., 55c.; per ¼-lb., \$1.50; per lb., \$5.50.

Strawberry or Ground Cherry. This grows in a husk or pod, and may be kept all winter if the husks are not removed. The fruit is yellow and has a very sweet, pleasant flavor; may be eaten raw, but is generally used for preserves. Price per oz., 55c.; per ¼-lb., \$1.50; per lb., \$5.50.

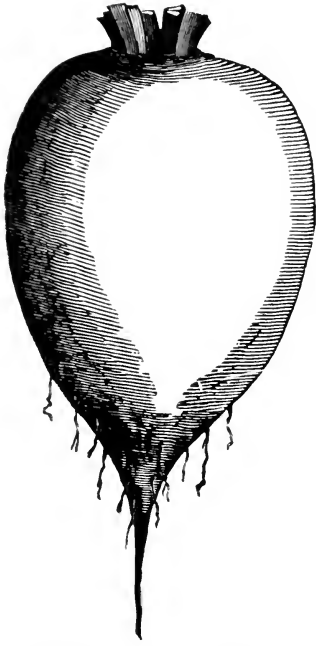

WHITE EGG TURNIP.

Turnip.

Rube—Nabo—Navone.

For early use, sow as soon as the ground can be worked in the spring, in drills fourteen inches apart, covering but slightly, except in dry weather. The soil should be light, and, if possible, new. Manure with plaster, ashes or phosphate. Thin the early varieties to six inches apart, and the *Ruta Bagas* from eight to ten inches. For fall and winter use, the early kinds should be sown in July and August and the *Ruta Bagas* through June. Hoe them a month after sowing.

Platt's White Egg. It is an early; very smooth, fine grained, white oval turnip, as its name indicates, and is unsurpassed for table use. Originated in a field of Cow Horn turnips growing in the vicinity of New Haven in 1870. It was introduced into commerce by Mr. Platt in 1877, and is now offered in nearly every seed catalogue of importance in America and Europe. Price per oz., 10c.; per ¼-lb., 25c.; per lb., 75c.

Early White Flat Dutch. A fine garden variety, differing from White Strap Leaf only in the shape of its leaf, which is broader and rough edged. Price per oz., 10c.; per ¼-lb., 25c.; per lb., 75c.

Early Red-Top Strap Leaf. A good flat turnip for early or late culture, and grows to large size. The top of the turnip is red or purple. Price per oz., 10c.; per ¼-lb., 20c.; per lb., 65c.

Long White or Cow Horn. A long, quick-growing turnip, fine grained, tender and sweet. Price per oz., 10c.; per ¼-lb., 20c.; per lb., 65c.

Red Top White Globe. Pure white with a red top, excellent table variety. Price per oz., 10c.; per ¼-lb., 20c.; per lb., 65c.

Golden Ball. Rapid grower, globe shaped, and of a deep yellow color, finest quality. Price per oz., 10c.; per ¼-lb., 25c.; per lb., 75c.

Amber Globe. Grows to a large size, light yellow, and is one of the best for general crop. Price per oz., 10c.; per ¼-lb., 25c.; per lb., 75c.

Yellow Aberdeen. (Green Top). This is globe shaped and a good keeper. Price per oz., 10c.; per ¼-lb., 20c.; per lb., 65c.

Seven Top. Cultivated for its abundance of tops, which are used for greens when young. Price per oz., 10c.; per ¼-lb., 20c.; per lb., 65c.



RED TOP WHITE GLOBE.

Swedish or Ruta Baga Varieties.

Platt's Golden Winter Ruta Baga. (The Best). This is the finest grained, hard, solid and sweet turnip; it is very productive and a good keeper; more wedge or spike shaped than other sorts. Price per pkt., 10c.; per oz., 15c.; per ¼-lb., 35c.; per lb., \$1.00.

American Purple Top Ruta Baga. A very hardy strain, selected for small tops and neck, deep globe-shaped, flesh bright yellow, hard and sweet, excellent for table or stock feeding; very popular with market gardeners. Price per oz., 10c.; per ¼-lb., 25c.; per lb., 75c.

White French. Sometimes called White Rock, on account of its firmness and solidity; flesh pure white, mild, very sweet. Price per oz., 10c.; ¼-lb., 25c.; lb., 75c.

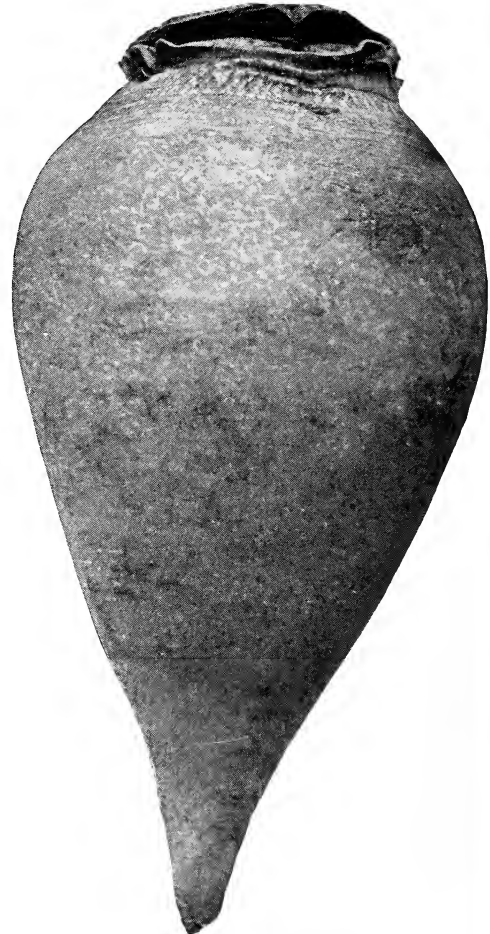

GOLDEN RUTA BAGA.

Witloof Chicory.

A crisp, Winter vegetable. Sometimes called French Endive. This makes one of the most delicious of all salads. It is also an excellent dish boiled. The seed is planted in May or June in the open ground and in the fall the roots are dug. The roots are then planted in earth in a dark cool place in the cellar or under greenhouse bench. Finely balanced, crisp leaves are then thrown out, and when cut new leaves form. The roots keep a long time and may be planted so that a fresh and delicious salad may be had all winter. Fancy fruit and vegetable dealers have imported this vegetable from France on account of its delicious flavor. Price per pkt., 10c.; per oz., 20c.; per ¼-lb., 60c.; per lb., \$2.00.



SAGE.



WITLOOF CHICORY.



SWEET MARJORAM.

Sweet, or Pot and Medicinal Herbs.

A few pot herbs, or sweet herbs, as they are usually called, should have a place in every vegetable garden. A very small space in the garden will give all the herbs needed in any family. The culture is very simple, and the best way is to make a little seed bed in early spring and set the plants out as soon as large enough. As a general rule, it is best to cut herbs when in flower, tie them up in small bunches and hang in the shade to dry.

The following is a list of herbs most cultivated and prized:

| | Pkt. | Oz. | ¼-lb. | Lb. |
|---------------------------|------|------|--------|--------|
| Anise | 10c. | 15c. | 50c. | \$1.50 |
| Balm | 10c. | 50c. | \$1.35 | \$5.00 |
| Sweet Basil | 10c. | 20c. | 50c. | \$1.50 |
| Borage | 10c. | 20c. | 50c. | \$1.50 |
| Caraway | 10c. | 15c. | 35c. | \$1.00 |
| Catnip | 10c. | 85c. | | |
| Coriander | 10c. | 15c. | 35c. | \$1.00 |
| Dill | 10c. | 15c. | 25c. | \$.75 |
| Sweet Fennel (large) | 10c. | 15c. | 40c. | \$1.50 |
| Horehound | 10c. | 30c. | 85c. | \$3.00 |
| Lavender (Vera) true | 10c. | 55c. | \$1.50 | \$5.50 |
| Sweet Marjoram | 10c. | 20c. | 50c. | \$1.75 |
| Rue | 10c. | 45c. | \$1.25 | \$4.50 |
| Sage, Broad Leaf English | 10c. | 20c. | 60c. | \$2.00 |
| Summer Savory | 10c. | 20c. | 50c. | \$1.75 |
| Thyme, Broad Leaf English | 10c. | 50c. | \$1.35 | \$5.00 |
| Wormwood | 10c. | 50c. | \$1.35 | \$5.00 |

INOCULATE ALL LEGUMES

Alfalfa, all Clovers, Soy Beans, Cow Peas, Peas, Beans, Vetch with

For profitable results, Agricultural Colleges advise inoculation for all legume seed, because it pays well in producing larger quality yields. Fresh, high count NITRAGIN, containing billions of nitrogen-gathering germs build up the soil. Costs less than others—is cheapest crop insurance. Insist on NITRAGIN.

Special Garden Size Composite Culture (4-in-one) to inoculate Garden Peas and Beans, Lima Beans and Sweet Peas. Sufficient for 8 lbs. Seed. . . . \$.25



THE ORIGINAL SOIL INOCULATOR
With the Date and Germ Count on every can

Every Can Stamped with Expiration Date
Fresh Each Year



Every 1 Bu. Size Can Packed with More Than 7 Billion Legume Germs

NITRAGIN PRICES

Culture A to inoculate Alfalfa and Sweet Clover also Culture B to inoculate Red, White, Alsike and Crimson Clover.

| Size | Inoculates | Price |
|--------|---------------|-------|
| ¼-bu., | 15 lbs. Seed | \$.40 |
| 1-bu., | 60 lbs. Seed | 1.00 |
| 5-bu., | 300 lbs. Seed | 4.75 |

Culture C for Peas and Vetch also Culture D for Field and Garden Beans.

| | | |
|--------|---------------|-------|
| ½-bu., | 30 lbs. Seed | \$.40 |
| 1-bu., | 60 lbs. Seed | .60 |
| 5-bu., | 300 lbs. Seed | 2.50 |

Culture E for Cow Peas and Lima Beans also Culture S for Soja Beans.

| | | |
|--------|--------------|-------|
| 1-bu., | 60 lbs. Seed | \$.40 |
|--------|--------------|-------|

IMPORTANT: When ordering NITRAGIN, always be sure to state kind of legume seed you wish to inoculate.

Nitragin has served the American Farmer since 1898.

The Frank S. Platt Company's

Choice Selection of High Germination and Purity Test

GRAINS, GRASSES AND FARM SEEDS

Our Special Mixture For Lawns, Permanent Pastures and Hay Are Unexcelled



HARVESTING LEAP'S PROLIFIC WHEAT.

Farm Seeds.

Prices on all grass and grain seeds subject to market fluctuations.

Sudan Grass. A forage crop of great value. Belongs to the sorghum family, is strictly an annual, 3 to 5 feet tall. Sow in drills or broadcast, 20 lbs. to the acre for hay or cutting green. When cut, grows again until frost. Price per lb., 13c.; per 100 lbs., \$8.00.

Evergreen Broom Corn. Best for general cultivation; brush fine and long. Price per lb., 20c.; per 100 lbs., \$15.00.

Sorghum or Early Amber Sugar Cane. Grows 10 to 12 feet high. Matures early and best adapted to the northern states, for syrup making. Used also for ensilage. Price per lb., 13c.; per 100 lbs., \$8.00.

Kaffir Corn. Both grain and fodder are excellent, the whole stalk tender to the full maturity of seed. The grain is used for feeding poultry. Price per lb., 11c.; per 100 lbs., \$6.00.

Flax Seed. Price per lb., 15c.; per 100 lbs., \$10.00.

Sunflower. Mammoth Russian. Large heads, grown for seeds. Per lb., 15c.; per 100 lbs., \$10.00.

Hemp. Price per lb., 11c.; per 100 lbs., \$6.00.

Vetches, Spring, or Tares. (*Vicia Sativa*). Of the Pea family, round black seeds. Usually sown with oats or barley for fodder. Culture same as field peas, two bushels per acre. Price per lb., 13c.; per 100 lbs., \$8.00.

Vetch, Sand, Winter or Hairy. (*Vicia Villosa*). Sow in early fall or spring, usually with rye for support; grows three to four feet and is ready to cut as soon as bloom appears, and again for seed. Price per lb., 20c.; per 100 lbs., \$15.00.

Peas, Canada Field. (See page 28). Price per quart, 25c.; per 100 lbs., \$7.00.

Whippoorwill, Southern Cow Peas. Is really a bean and should not be confused with Canada Field Peas. They are more tender than Soja Beans, which are better adapted to points north of New Jersey. Used for plowing under, sow 90 lbs. per acre. Price per lb., 13c.; per 100 lbs., \$6.00.

Soja Bean, Hollybrook or Midwest. We have found this to be one of the most desirable sorts for our northern states for use either as a forage crop or plowing in. The pods develop sufficiently if sown in May or June to add greatly to the food value. Price per lb., 11c.; per 100 lbs., \$6.00.



SAND, WINTER OR HAIRY VETCH WITH RYE.

Spring Wheat.

Prices on all grains subject to market fluctuations.

Marquis. Beardless. This is the **\$1,000.00 Prize Spring Wheat**, and also graded A1 flour product at the Saskatchewan Baking Contest. It is a plump, hard, dark red berry, making a fine appearance in bulk. It matures about ten days earlier than our ordinary varieties, bearing its head of good size, well up on good stiff straw. Price per ¼-bu., 60c.; per bu., \$2.00.

Winter Wheat.

Prices on all grains subject to market fluctuations.

Leap's Prolific. Beardless, golden chaff, grain hard; large dark red. Straw long and stiff; ripens early. Sow 1½ bushels per acre. Price per bu., \$2.00.

Klondyke. Bald. White variety of special value in the East; large berry and very productive. Price per bu., \$2.00.

Buckwheat.

Prices on all grains subject to market fluctuations.

Japanese. Straw heavier, branches more, and not sown thick as other kinds. Price per ¼-bu., 60c.; per bu., \$2.00.

Silver Hull. Heavy yielder; berry is small, light, silvery gray color. Price per ¼-bu., 60c.; per bu., \$2.00.

Spring Barley.

Prices on all grains subject to market fluctuations.

Two-Rowed Chevalier. Very large, plump berry. Per ¼-bu., 75c.; bu., \$2.50.

Oderbrucker (Wisconsin No. 55). Six-rowed; heavy yielding sort, with long, full heads; stools freely; the protein content is very high, nearly twice the ordinary. Per ¼-bu., 50c.; per bu., \$1.75.

Beardless. Similar in appearance to the six-rowed varieties while growing, but the beard does not develop and it is much pleasanter to handle while harvesting and cleaning. It is also better for feeding, as stock do not suffer from the sharp needle-like spines. Per ¼-bu., 75c.; bu., \$2.75.

Rye.

Prices on all grains subject to market fluctuations.

Spring. It is an excellent catch-crop where winter grain has been killed out, making good straw and fair yield of grain. Per ¼-bu., 60c.; per bu., \$2.00.

FALL OR WINTER RYE.

Rosen. A very superior and productive sort from Russia, introduced by the Michigan Agricultural College. The yield is often double that of the common. We exercise care to obtain only pure seed. Per pk., 60c.; per bu., \$1.50.

Oats.

Prices on all grains subject to market fluctuations.

Choice White. Per ¼-bu., 35c.; bu., \$1.25.

Swedish Select. It will pay well, whether for cutting green or grain is desired, to sow these heavy yielding oats; kernel white, very large, strong, stiff straw. Where common have been grown the yield is often increased 25 to 50 per cent. Price per ¼-bu., 45c.; per bu., \$1.50.



SWEDISH SELECT OATS.

OUR SPECIAL GRASS MIXTURES

Owing to Market Fluctuations We Will Give Special Quotations for Bulk Seeds.



Grass Seed for Lawns, Athletic Fields, Etc.

Grass is the most beautiful outdoor carpet. The photos here show a country home before and after seeding, a home lawn in New Haven, the Lee Press on the Post Road and a scene on the New Haven Municipal Golf Course.

We are prepared to make up special formulas on short notice but do not carry in stock the lightweight grades so frequently used to quote low prices, which in reality are high, not only because of the large percentage of inert matter but low germinating power. Coarse grasses, such as Domestic or Italian Rye Grass, should be used only in moderate quantities when a nurse crop is required.

In laying out a piece of ground for a lawn, care should be exercised to obtain the grade, and perfect the general plan of the ground before attempting to sow any seed at all. After the correct grade has been obtained and the surface sufficiently plowed or spaded it should be thoroughly harrowed to pulverize the lumps and so left that there will be at least four inches of good rich top soil over the whole surface. Remove all roots and loose stones, brush the surface or rake down perfectly smooth, and in a suitable condition for successful germination and growth of the fine seed, which is used for seeding. Leave the soil in this condition 5 to 15 days or more before seeding is desirable, when possible, especially in spring sowing. During this time many weed seeds in the soil germinate and are easily killed by pulling or very shallow raking.

A lawn is kept closely cut and a dense turf of fine grasses is desired. For that reason seed should be sown much thicker (100-150 lbs. per acre) than the coarse sorts that are used in field seeding. After sowing the seed, rake the surface lightly; roll to firm the soil if necessary. Avoid forming a crust or hard surface often caused by rolling too heavy or when wet.

Platt's Evergreen Lawn Seed.

Best for general purposes. Contains heavy grade, thoroughly re-cleaned seeds only of Kentucky Blue Grass, Red Top, Rhode Island Bent, White Clover and Italian Rye Grass. The many beautiful lawns that have been produced with Platt's Evergreen Lawn Seed and Platt's Shady Nook, about private homes, churches, universities and other public buildings are proofs of the exceptionally high-grade and suitable seeds used in these formulas. Please note our seed weighs 28 lbs. per bushel. Price per pt., 25c.; per qt., 40c.; per ½-bu., \$1.35; per ¼-bu., \$2.50; per ½-bu., \$4.75; per bu., \$9.50. Use ⅓-bu. for each 1000 sq. ft. new seeding.

Edgewood Park Lawn Grass Seed.

This formula is well-balanced and contains heavy re-cleaned Kentucky Blue Grass and Red Top only. We are satisfied these grasses are an excellent combination for lawns, fairways and places where neither White Clover or any Bent grass is desired. The seeds used in this mixture are of exceptional purity, graded, fancy re-cleaned. On account of their character and purity, much less bulk is required for a given area; 100 to 150 lbs. per acre, or 3 lbs. per 1,000 sq. ft. Sold by weight only. Price per lb., 30c.; per 10 lbs., \$2.50; per 100 lbs., \$25.00.

Platt's Premier Lawn Seed.

Sets a new high standard for fine quality and at the same time lends itself with advantage to the so-called Weedless lawn method of fertilizing. The combination of highly refined Rhode Island Bent and Kentucky Blue Grass is unexcelled for fine texture and close turf, of exquisite color. Price subject to change. Per lb., \$1.00; per 10 lbs., \$9.50; per 100 lbs., \$90.00.

Platt's "Shady Nook" Lawn Seed.

Many beautiful lawns are marred by bare spots under trees and near ornamental shrubbery or buildings.

Our Shady Nook is composed mainly of short fine grasses that will withstand such conditions better than our other mixtures. It is important that soil fertility and moisture supply is well provided for in places getting but little sunshine.

For best results the land must be dug deeply, removing roots of trees and vines, these being largely responsible for lack of grass roots. A heavy coat of manure, dug in, and a dressing of bone, when seeding, should complete the usual necessary preparation. Weight per bu., 28 lbs., Price per pt., 30c.; per qt., 45c.; per ½-bu., \$1.60; per ¼-bu., \$2.75; per bu., \$10.00.

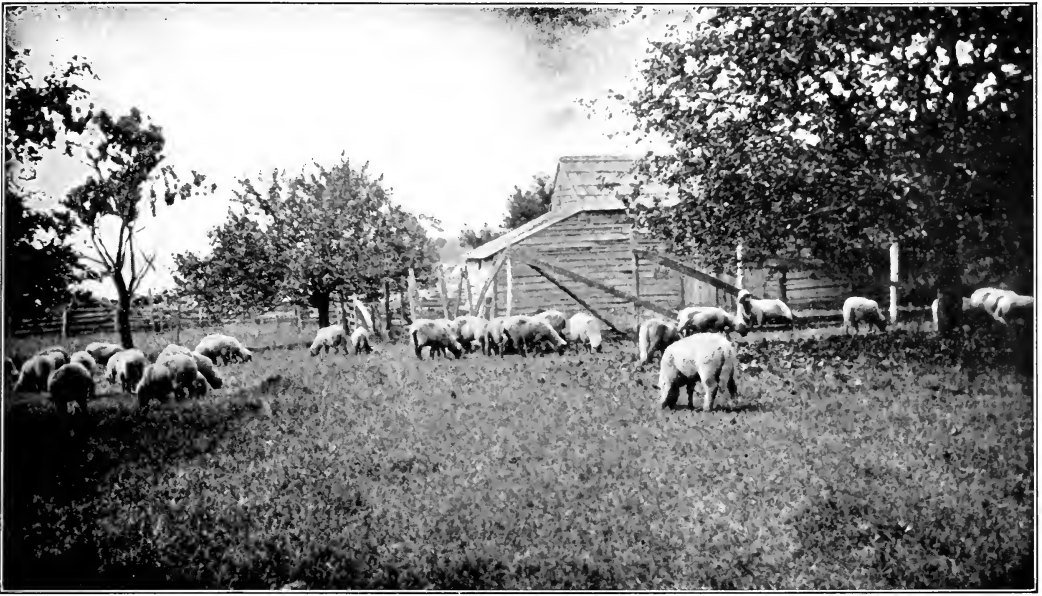

Hay and Pasture Grass Seeds.

Prices subject to variation. Special quotations for large quantities.

Mixture for Hay and Permanent Pasture. Consists of a number of grasses long recognized as the best combination for this latitude; two bushels per acre. Price per $\frac{1}{4}$ -bu., \$1.75; per bu., of 25 lbs., \$6.00.

English Rye Grass. A nutritious, permanent grass for meadows and pastures, also as nurse crop with others for lawns. Price per lb., 20c.; per 100 lbs., \$15.00.

Italian Rye Grass. A quick-germinating, vigorous grass, similar to the English, except not so hardy and therefore preferred as a nurse crop with fine, slow-growing, but more permanent grasses. It is desired to have the nurse crop cease to exist after it has served its purpose. Price per lb., 20c.; per 100 lbs., \$15.00.

Red Top Fancy Cleaned. Heavy re-cleaned seed. Important both agriculturally and for making turf. Excellent in combination with Kentucky Blue or others, but too coarse after first year to be sown alone on fine lawns. Germinates quickly. Price per lb., 20c.; per 100 lbs., \$16.00.

Rhode Island Bent. (*Agrostis Tenuis*). Prince Edward Island grown. Considered the finest and most reliable type of Bent for fine lawns in the Northeastern States. It keeps its roots below the ground surface and is almost immune to fungus diseases. Price per lb., \$1.75; per 100 lbs., \$155.00.

New Zealand grown. Rhode Island Bent. Price per lb., \$1.25; per 100 lbs., \$115.00.

South German Mixed Bent. (*Agrostis* App.). Incorrectly called Creeping Bent. Very fine leaved and of creeping habit. Forms close, dense turf. Used on fine lawns and golf greens. Price per lb., \$1.35; per 100 lbs., \$125.00.

Fancy Kentucky Blue. (*Poa Pratensis*). Valuable for lawns when mixed with other varieties. It germinates slowly two to three weeks and requires a year or more to establish strong turf. It requires a rich soil but not necessarily a limestone

soil. Extra heavy cleaned seed. Price per lb., 30c.; per 100 lbs., \$25.00.

Canada Blue. (*Poa Compressa*). A hardy perennial grass, with creeping rootstalks, forming a durable turf, though not so compact as Kentucky Blue. It grows on poor and dry soils, standing extremes of wet or drought, and keeping green until the severe frosts of winter. It is distinguished from the Kentucky Blue Grass by its flattened, wiry stems and bluer color. (14 lbs. to the bushel). Price per lb., 30c.; per 100 lbs., \$25.00.

Meadow Fescue or English Blue Grass. (*Festuca Pratensis*). A highly valuable species for permanent grass land. It does not, however, attain to its full productive power till the second or third year, when it far exceeds most other sorts in the quantity of its produce and nutritive matter. Price per lb., 25c.; per 100 lbs., \$20.00.

Red Fescue (*Festuca Rubra*). A deep-rooted grass. It thrives on dry sandy soils, and remarkably well in shade, forming a good turf surface, especially valuable for steep slopes on lawns. It is the only fine-leaved fescue forming a dense smooth turf. Price per lb., 50c.; per 100 lbs., \$45.00.

Rough Stalked Meadow Grass. (*Poa Trivialis*). Resembles Kentucky Blue in appearance. Most valuable grass for shady lawns where there is reasonable amount of moisture. Price per lb., 35c.; per 100 lbs., \$30.00.

Orchard Grass. (*Dactylis Glomerata*). One of the most desirable pasture grasses for stock and for shady places. Price per lb., 25c.; per 100 lbs., \$20.00.

Timothy. (*Phleum Pratense*). A well-known grass, and more generally grown than any other variety for hay. High-grade, clean seed is of greatest importance. We carry a large stock of this seed, buying in car lots, which is graded and sold on basis of purity and germination tests. Prices on application.

Millets.

Prices given on application.

Hungarian Millet. Early; height two or three feet; abundant foliage and small heads; yields well on light soils. Per lb., 9c.; per 100 lbs., \$7.00.



GOLDEN MILLET.

True Southern or Tennessee Millet. Equal in quality to any of the other millets and far superior in yield to the Common or Golden, growing from three to five feet high, with abundant foliage, and terminating with large seed heads, formed by numerous panicles of small round, bright golden yellow seeds. Price per lb., 10c.; per 100 lbs., \$7.00.

Japanese or Barn Yard. (Billion Dollar Grass). Forage plants of great value, growing luxuriantly on most any soil and under indifferent conditions. It will grow in seasons of extreme drought and attain a height of six feet. When cut continues to grow until frost. Price per lb., 12c.; per 100 lbs. and over @ \$8.00.

Clover.

Alsike or Hybrid Clover. (*Trifolium Hybridum*). Even poorly drained lands will produce a good crop of this; perennial and very hardy. It is very valuable both for pasturing and soiling; very productive, sweet and fragrant. The flowers are a

distinct light pink, and much liked by bees. Price per lb., 30c.; per 100 lbs., \$25.00.

Crimson Trefoil or Scarlet Italian Clover. (*Trifolium Incarnatum*). An annual, valuable as a cover crop, soil improver or for fodder; attains a height of eighteen inches with pointed bright crimson blossoms. It is not reliably hardy north of Philadelphia. Per lb., 18c.; per 100 lbs., \$15.00.

White Clover. (*Trifolium Repens*.) Thrives best in damp locations, and while not a heavy producer, it is valuable in permanent pastures. In connection with Blue Grass it affords the most nutritious food for sheep and cattle, and also makes a fine addition to mixture for lawns. Choice, (high test seed). Per oz., 10c.; per ¼-lb., 20c.; per lb., 75c.; 25 lbs. and over, price on application on account of market fluctuations.

Sweet Clover. (*Melilotus Alba*). Valuable biennial, thrives almost anywhere except on acid soils. One of the greatest plants known for soil improvement; feed value equal to alfalfa; used extensively by bee-keepers. Sow at rate of 18 to 20 lbs. per acre; April or August usually most satisfactory. Price per lb., 20c.; per 100 lbs., \$14.00.

Red Clover, Medium. (*Trifolium Pratense*). The common variety, used with other grasses for either pasture or meadow. Per lb., 30c.; per 100 lbs., \$26.00.

Red Clover, Mammoth, or Pea Vine. Grows much taller than medium, with large, coarse stalks, and is largely used for plowing under for green manure. Price per lb., 35c.; per 100 lbs., \$28.00.

Alfalfa. (*Medicago Sativa*). Very productive, succeeds in any good soil that is well drained and not acid; lasts for a number of years. It thrives on dry, rich sandy soil, producing three to four cuttings annually, and even in seasons of severe drought it is always fresh and green, because the roots extend so deep into the soil. It grows two to three feet high, with purple blossoms. Hardiness and purity are of more importance when buying alfalfa seed than a slight difference in price. Sow 20 to 25 lbs. per acre. Price per lb., 35c.; per 100 lbs., \$30.00.

Grimm. This is the very hardy variety which has given such satisfaction in our northeastern states. We exercise great care to have the genuine, and usually have State-sealed grades. Per lb., 45c.; per 100 lbs., \$40.00.

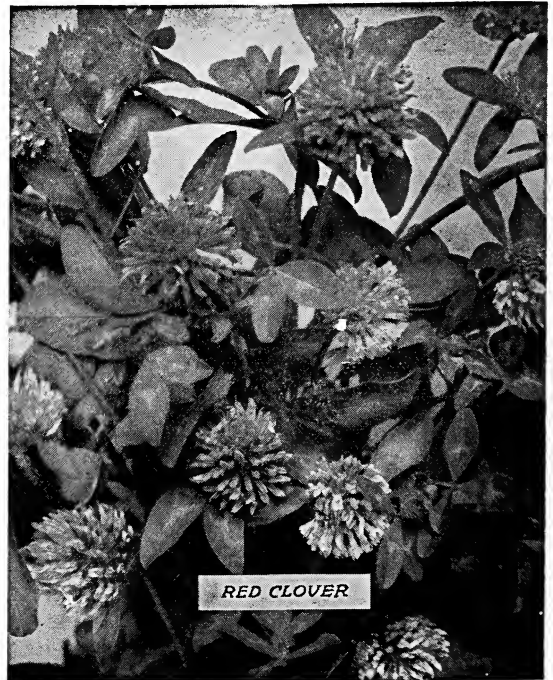

RED CLOVER



Platt's Select Flower Seeds

Specialists in America and Europe have in recent years greatly improved many of our annuals and perennials through scientific plant breeding and selection. Continued important developments are sure to be of interest. We have given much care to secure these finest strains, and careful comparison will show they are superior to those ordinarily obtainable. We feel sure Platt's Seeds will please both old and new customers.

Abronia.

Extremely pretty creeping annual; verbena-like heads of sweet-scented flowers; very effective in beds, rock work or hanging baskets.

Umbellata. Rosy lilac. White eye. Price per oz., 50c.; per pkt., 10c.

Abutilon.

A tender perennial shrub, producing bell-shaped drooping flowers of various colors.

Finest Mixed. Hybridum Maximum. Price per 1/8-oz., \$2.50; per pkt., 25c.

Achillea.

"The Pearl." Ptarmica Fl. Pl. Improved. Double white, hardy perennial, grown easily from seed, blooms first season, if sown early, and continues in profusion all summer. Excellent as a cut flower; height 2 feet. Price per 1/8-oz., \$1.00; per pkt., 10c.

Acroclinium.

Pretty summer-flowering annuals, bearing quantities of large, semi-double, everlasting flowers, of white, rose, etc.

Double Rose. Price per oz., 60c.; per pkt., 10c.

Double Mixed. Price per oz., 60c.; per pkt., 10c.

Ageratum.

A Mexican flower of bush-like appearance, suitable for bedding or pot culture. Blooms continually. Annual.

Blue Perfection. Large flowered, free-blooming, the darkest blue, ten inches. Per oz., 60c.; per pkt., 10c.

Imperial Dwarf White. Eight inches. Price per oz., 75c.; per pkt., 10c.

Imperial Dwarf Blue. Clear blue, eight inches. Price per oz., 60c.; per pkt., 10c.

Agrostemma.

An attractive, free-flowering hardy perennial, producing flowers on long, slender stems like a single pink; blossoms the first season.

Coronaria. (Rose of Heaven). Dark blood red. Price per oz., 35c.; per pkt., 10c.

Alyssum Sweet.

A very pretty little plant for edging or ribbon lines, blooming all summer. Hardy annual.

Maritimum. Fragrant white; flowers all summer; somewhat trailing, suitable for broad edges and vases. Price per oz., 25c.; per pkt., 5c.

Carpet of Snow. Two to three inches high. Fine for edging. Price per oz., 60c.; per pkt., 10c.

Compactum, Little Gem. Grows compact and erect; six inches. Price per oz., 50c.; per pkt., 10c.

Saxatile Compactum. Single plants produce many hundred of bright yellow flower-heads; one foot. Hardy perennial. Price per oz., \$1.00; per pkt., 10c.

Amaranthus.

Ornamental foliage plants of extremely brilliant and showy colors. Half-hardy annual.

Tricolor. (Joseph's Coat). Leaves yellow, red and green. Price per oz., 75c.; per pkt., 10c.

Caudatus. (Love Lies Bleeding). Flowers in bunches of long, drooping, chenille-like tassels. Price per oz., 30c.; per pkt., 10c.

Salicifolius. (Fountain Plant). Gracefully drooping, willow-shaped leaves. Per oz., \$1.00; per pkt., 10c.

Fine Mixed. Price per oz., 30c.; per pkt., 10c.

Ampelopsis.

Veitchii. (Boston or Japanese Ivy). Valuable hardy climber, clinging to stone or brick walls, ivy green foliage. Price per oz., 50c.; per pkt., 10c.

Anchusa.

Italica Dropmore Variety. A greatly improved perennial type, grows 3 feet tall, blooms during June and July and if cut back will flower again in September. The flowers resemble large forget-me-nots of lovely gentian blue. Price per oz., \$1.00; per pkt., 10c.

Carpensis. (Summer Forget-me-not). Best treated as an annual, height 18 inches, blooms freely all summer; fine for cut flowers. Price per oz., 50c.; per pkt., 10c.

Blue Bird. Annual. New Compact indigo blue. Price per oz., 75c.; per pkt., 10c.

Antirrhinum.

Snapdragon.

One of the most useful summer-flowering perennials, producing long spikes and beautiful bright-colored flowers the first season. The following are selected for their type and color from stocks grown by specialists. New Maximum group, surpassing anything yet introduced.

| | | |
|---|------------|-------------|
| Canary Bird. (Florists' strain). Ca. nary yellow | Oz. | Pkt. |
| | \$4.00 | 15c. |
| Copper King. Bronzy copper | 4.00 | 15c. |
| Old Gold. Rose on yellow ground.. | 4.00 | 15c. |
| Snowflake. White | 3.50 | 15c. |
| The Rose. (Florists' strain). Begonia rose | 4.00 | 15c. |
| Maximum Mixed. All varieties | 1.75 | 10c. |

MANUM GRANDIFLORUM (SEMI-DWARF) LARGE FLOWERED.

| | | |
|---|--------|------|
| Empress. Rich velvety crimson | \$2.50 | 10c. |
| Golden Queen. Clear yellow | 1.75 | 10c. |
| Pink Perfection. New Hermosa-Pink suffused salmon. Better than Silver Pink | 2.50 | 10c. |
| Purity. (Florists' strain). Pure white | 1.75 | 10c. |
| Semi-Dwarf Large Flowered Mixed | 1.50 | 10c. |

Aquilegia.

Columbine.

A very graceful plant, with spurred blossoms in great variety of colors; ranks among the finest early flowering. Hardy perennials.

Chrysantha. Golden spurred flowers \$2.00 10c.
Snow Queen. Long spurred. Pure white flowers. Per 1/8-oz., \$1.25; pkt., 15c.

Pink Shades. Long spurred. Per 1/8-oz., \$1.00; pkt., 15c.

Long Spurred Hybrids. Mrs. Scott Elliott's strain. A very choice strain possessing a wide-range of beautiful new colorings

| | | |
|---|--------|------|
| | \$5.00 | 10c. |
| Double Varieties. All colors mixed.. | 1.25 | 10c. |
| Single Varieties. All colors mixed.. | 1.00 | 10c. |

Aristolochia.

Sipho. (Dutchman's Pipe). Luxuriant, hardy climber with large, dense foliage; flowers small and curiously formed, resembling a Dutchman's pipe. Thirty feet. Price per oz., \$6.00; per pkt., 10c.

Asparagus.

Plumosa Nanus. Graceful, bright green, lacy, fern-like foliage. Per 100 seeds, 75c.; pkt., 15c.

Sprengeri. Decorative drooping fronds; excellent for hanging baskets and window boxes. Per 100 seeds, 50c.; per pkt., 15c.

Asperula.

A profuse blooming hardy annual, attaining an average growth of one foot. The flowers, which are beautiful light blue, are very sweet scented, and last a long time in perfection.

Azurea Setosa. Grows about 9 inches high and covered throughout the summer with light lavender fragrant flowers. Price per oz., 30c.; per pkt., 10c.

Odorata. (Sweet Woodruff). The dried flowers and leaves have a delicious fragrance and impart an agreeable perfume to clothes, etc., when kept among them. Price per oz., \$1.00; per pkt., 10c.

Platt's Superb Asters.

We wish to call special attention to our selection of this popular annual. The seed here offered is grown with the utmost care. No pains have been spared to bring each variety to its present high state of perfection, the very best it is possible to produce. For such seed, our prices are very moderate.

To appreciate asters grow them in separate colors and varieties and have them from July until hard frost.



ASTER, PLATT'S LATE BRANCHING.

Asters.

Queen of the Market. The best first early, a medium sized flower, perfectly double, of branching habit, good form and stem, about two weeks earlier than late branching.

| | | | |
|---------------------|-------------|----------------|------------|
| | Pkt. | 1/8-oz. | Oz. |
| Lavender | 10c. | 40c. | \$1.50 |
| Peach Blossom | 10c. | 40c. | 1.50 |
| Purple | 10c. | 40c. | 1.50 |
| Rose | 10c. | 40c. | 1.50 |
| White | 10c. | 40c. | 1.50 |
| Mixed | 10c. | 40c. | 1.50 |

Asters—Continued.

American Branching. Platt's. Undoubtedly the most popular of this type. While there are many other beautiful varieties for the colors here listed, they are unexcelled as a standard. Plants large, vigorous, branching, with strong stems. Flowers of great size, very full to the center. Our strain of this superb aster has been grown with such care we unhesitatingly believe it is unsurpassed.

| | Pkt. | ¼-oz. | Oz. |
|------------------------------|------|-------|--------|
| Crimson (Heart of France ... | 10c. | 60c. | \$2.25 |
| Lavender | 10c. | 40c. | 1.50 |
| Shell Pink (Mary Semples).. | 10c. | 40c. | 1.50 |
| Purple | 10c. | 40c. | 1.50 |
| Rose (Deep) | 10c. | 40c. | 1.50 |
| White | 10c. | 40c. | 1.50 |
| Mixed | 10c. | 40c. | 1.50 |

Beauty Asters. (Early Type). This type, recently introduced, has all the characteristics of the Late Beauty type; strong branching plants; long stems; large, well-formed flowers, and is valuable for location where the season is too late to flower the Late Beauty (latest of all Asters). It is not an early Aster as compared to Queen of the Market, but earlier than Late Beauty. Blooms at the same time as American Branching and flower is of that type, but larger.

| | Pkt. | ¼-oz. | Oz. |
|--|------|-------|--------|
| Azure Fairy. Azure blue or dark lavender | 10c. | 55c. | \$2.00 |
| Rose | 10c. | 55c. | 2.00 |
| Rose Pink (New) Lavender pink | 10c. | 55c. | 2.00 |
| White | 10c. | 55c. | 2.00 |
| Finest Mixed | 10c. | 55c. | 2.00 |

Giant of California. We highly recommend this grand Aster to both Florists and private gardeners. Great improvement has been made in this pleasing type since its introduction. Giants of California are by far the largest and most beautiful of the Crego or Chrysanthemum class. The flowers measure up to six inches across, packed with broad petals, and may be grown with stems 30 inches long. Peach Blossom is quite distinct. It opens as a white and flushes pink when in full bloom. Light Blue is an exceptionally fine flower, although delicate, has sufficient degree of intensity to please the most critical eye. Rose is a very rich, deep shade. The Horticultural Trade Journal of London, England, in commenting on Giants of California states, "It is truly an aristocrat amongst Asters."

| | Pkt. | ¼-oz. | Oz. |
|---------------------|------|-------|--------|
| Blue (Light) | 15c. | 75c. | \$2.75 |
| Peach Blossom | 15c. | 75c. | 2.75 |
| Purple (Dark) | 15c. | 75c. | 2.75 |
| Rose (Deep) | 15c. | 75c. | 2.75 |
| White | 15c. | 75c. | 2.75 |
| Mixed | 15c. | 75c. | 2.75 |

Astermum. A distinct strain of Comet type. Mixed, per pkt., 10c.; per ¼-oz., 50c.

King Asters. (Needled Type). The plants are similar in growth to the late branching, except the white and rose, which are more upright. The flowers are distinct, having long narrow, folded petals, presenting a most pleasing and beautiful appearance. Blooms about the same time as late branching.

| | Pkt. | ¼-oz. | Oz. |
|-------------------------|------|-------|--------|
| King Mixed Colors | 10c. | 40c. | \$1.50 |

Single Asters. Single Asters have a beautiful charm and simplicity of their own. The colors range same as in the doubles. We believe this new

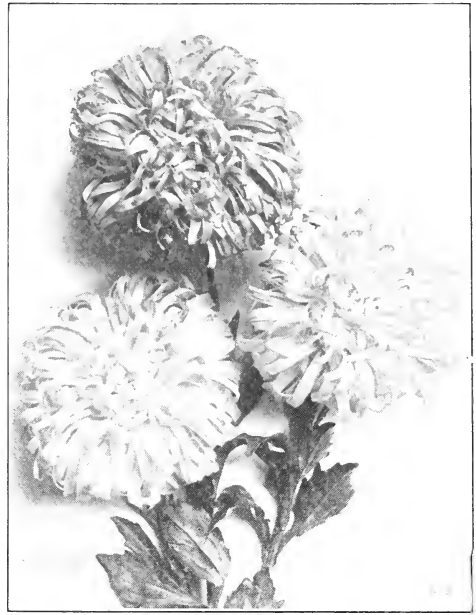

ASTER GIANTS OF CALIFORNIA.

single type of Aster destined to become very popular. Single Giants Mixed. Price per ¼-oz., 50c.; per pkt., 10c.

California Sunshine. Improved. Single Anemone-flowered, center of flower filled with florets. A very artistic, beautiful and useful flower. Stems long and strong. Price per ⅛-oz., 75c.; per pkt., 15c.

Auricula.

See *Primula Auricula*.

Balloon Vine.

Cardiospermum—Love in a Puff.

Rapid-growing climber, remarkable for its inflated seed pods, from which it is sometimes called "Balloon Vine." Annual.

Halicacabum. White. Per oz., 25c.; per pkt., 10c.

Balsam.

They are among the showiest and most popular of our summer garden annuals, forming bushy plants, covered with double flowers of brilliant colors.

Salmon King. Bright salmon pink; very early and double. Price per oz., \$1.00; per pkt., 10c.

Double Scarlet. Camellia flowered. Price per oz., \$1.00; per pkt., 10c.

White Perfection. Camellia flowered. Large double, pure white, Per oz., \$1.00; per pkt., 10c.

Double Camellia Flowered. Finest Mixed. Price per oz., 75c.; per pkt., 10c.

Balsam Apple.

(See *Mormodica*.)

Bartonia.

Showy garden annual with bright yellow flowers 1½ ft. Price per oz., 75c.; per pkt., 10c.

Begonia.

Sow in February or March in pots, without any covering of earth. Cover with glass and keep in a warm but shaded place. The plants will give an abundance of bloom the first year, and if properly kept, tubers will flower more freely than before. Begonias thrive in either shade or sunshine.

TUBEROUS-ROOTED BEGONIAS.

Single Mixed. Splendid large flowered. Price per $\frac{1}{4}$ -oz., \$2.00; per pkt., 25c.

Single Mixed Fringed. New, splendid strain. Price per $\frac{1}{4}$ -oz., \$3.00; per pkt., 25c.

Double Mixed. From a very rich collection. Price per $\frac{1}{4}$ -oz., \$5.00; per pkt., 35c.

FIBROUS-ROOTED BEGONIAS.

Begonias offered under this head have attractive foliage, among the most desirable for flowering in the house. Bedding in partly shaded locations or under full sunshine outdoors continue in full bloom throughout the season.

Erfordia Grandiflora Superba Semperflorens. Rosy carmine, a beautiful free bloomer. Price per $\frac{1}{4}$ -oz., \$4.00; per pkt., 25c.

Prima Donna. Large flowers, limpid rose, shading to carmine. price per $\frac{1}{4}$ -oz., \$6.00; per pkt., 25c.

Vernon Compacta. Flowers brilliant purplish-carmine; bronze leaves; good for bedding. Price per $\frac{1}{2}$ -oz., \$2.50; per pkt., 25c.

Semperflorens Mixed. A variety well adapted for house or outdoor culture. Plants of compact dwarf habit, and are continuous bloomers. Price per $\frac{1}{8}$ -oz., 75c.; per pkt., 10c.

Bellis Perennis.

Double Daisy.

Prefers a cool, sheltered situation, and needs some protection in winter. Flowers are quilled or flat petaled, white, red or variegated. Half-hardy perennial.

Monstrosa Rose. Fine, large, double dark rose flowers. Price per $\frac{1}{8}$ -oz., 75c.; per pkt., 10c.

Monstrosa White. Pure white, large and very double. Price per $\frac{1}{8}$ -oz., 75c.; per pkt., 10c.

Monstrosa Red. Double and unusually large flowers, red shading to rose. Price per $\frac{1}{8}$ -oz., \$2.00; per pkt., 20c.

Monstrosa Double Mixed. Price per $\frac{1}{8}$ -oz., 50c.; per pkt., 10c.

Brachycome.

Swan River Daisy.

A delicate dwarf, half-hardy, annual, effective for edging, beds or rustic baskets. Produces an abundance of daisy-like flowers about an inch in diameter and in shades from dark blue to nearly white. Price per oz., \$1.00; per pkt., 10c.

Browallia.

Profuse blooming plants, continuing throughout the summer, studded with blue and white flowers, growing freely in any rich soil. Half-hardy annual.

Speciosa Majus. Splendid large, blue flowers. Price per $\frac{1}{2}$ -oz., \$2.50; per pkt., 15c.

Elata Mixed. Price per oz., 75c.; per pkt., 10c.

Cacalia.

Tassel Flower.

A pretty half-hardy annual, with tassel-shaped flowers, scarlet and golden yellow. Blooms from July to September.

Mixed Colors. Price per oz., 75c.; per pkt., 10c.

Calandrinia.

Very pretty plants, succulent stems and fleshy leaves, belonging to the Purslane family. Annual.

Grandiflora. Large flowered rosy pink. Price per oz., 75c.; per pkt., 10c.

Calceolaria.

Splendid plants for greenhouse decorations, forming in spring dense masses of beautiful pocket-like flowers. The seeds germinate best without heat, and should be grown in pans or pots.

Hybrida Grandiflora Mixture. Giant strain, large flowers, very choice. Mottled and spotted. Price per $\frac{1}{4}$ -oz., \$3.50; per pkt., 25c.



CALLIOPSIS.

Calliopsis.

Black-Eyed Susan.

Calliopsis (see also Coreopsis).

Few, if any, annuals are more useful than these; the colors are rich and striking; flowers numerous and beautiful. Annual.

(For perennial varieties, see Coreopsis).

Coronata Maxima. Height 18-24 inches. Large single yellow flowers. Price per oz., 40c.; per pkt., 10c.

Dazzler. A new compact variety, height 12 inches, improved in habit and flower. Rich maroon center with broad golden yellow border. Price per oz., 75c.; per pkt., 10c.

Fire King. Compacta. Deep, bright scarlet. Height 18 inches. Price per oz., \$1.75; per pkt., 10c.

Dwarf Mixed. Price per oz., 40c.; per pkt., 10c.

Nigra Speciosa. 2½-3 feet. Rich maroon. Price per oz., 40c.; per pkt., 10c.

Splendens. 2½-3 feet. Large golden flowers with maroon center. Price per oz., 40c.; per pkt., 10c.

Hybrida. Semi-Double Mixed. 2½-3 feet. Price per oz., 40c.; per pkt., 10c.

Calendula.

Pot Marigold.

Showy, free flowering hardy annuals growing in any good garden soil, producing a fine effect in beds or mixed borders and continuing in bloom until killed by hard frosts.

Ball's Gold. (Improved Florists' Strain). Dark golden yellow. Price per oz., \$1.50; per pkt., 10c.

Campfire. (Sensation). New. The flowers are extremely large, dark orange, with a scarlet sheen. Strong stems with few buds gives it advantages over all others for forcing. Price per oz., \$1.50; per pkt., 15c.

Meteor. Large double light yellow flowers, striped with bright orange. Price per oz., 30c.; per pkt., 10c.

Nankeen. Cream flushed apricot. Price per oz., 30c.; pkt., 10c.

Orange King. Splendid, large double-flowered, deep orange. Price per oz., 35c.; per pkt., 10c.

Radio. Distinct new type; globular and quilled; rich orange. Price per oz., 75c.; per pkt., 15c;

The Ball. (Florists' Forcing Strain). A selection from Orange King and now finest of all bright orange with lighter center. Price per oz., \$1.50; per pkt., 10c.

Double Mixed. Price per oz., 25c.; per pkt., 5c.



CALENDULA THE BALL.

Campanula.

Hardy, herbaceous perennials, bearing attractive bell flowers, thriving best in light rich soil; some of the varieties flower first season if planted early. *Carpatica* is fine for beds, edgings and ribbon gardening.

Campanula Pyramidalis. Large flowers of a beautiful blue, borne on spikes 3 to 4 feet tall. Price per oz., \$2.50; per pkt., 10c.

Carpatica Blue. Single. Free flowering; continuing in bloom the whole season; hardy perennials; six inches. Price per oz., \$1.50; per pkt., 10c.

Carpatica Alba. Per oz., \$1.50; per pkt., 10c.

Persicifolia Mixed. Blue and white. Single, flowering in July and August. 2 to 3 feet. Price per oz., \$4.50; per pkt., 10c.

Canary Bird Flower.

Tropaeolum Canariensis.

An ornamental creeper, with bright, yellow fringed flowers, resembling a canary bird with wings, partly spread, and finely divided foliage.

Yellow. Price per oz., 60c.; per pkt., 10c.

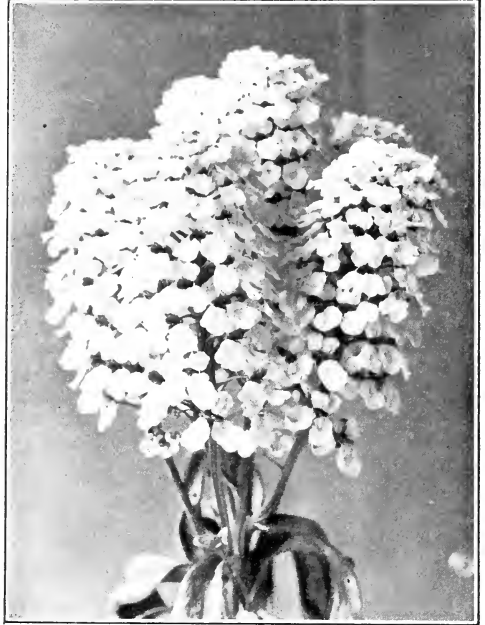

EMPRESS CANDYTUFT.

Candytuft.

Seed sown in April flowers from July to September, and some of the sorts until frost. All the varieties are easy to cultivate. Single plants look well and bloom profusely. Hardy annuals, one foot high.

Empress or White Giant Hyacinth Flowered. Improved strain. Pure white flowers, borne on candelabra-shaped plant. Per oz., 75c.; per pkt., 10c.

Carmine. Rich red. Per oz., 35c.; per pkt., 10c.

Crimson. Dark red. Per oz., 35c.; per pkt., 10c.

Lavender. Delicate rosy lavender. Per oz., 35c.; per pkt., 10c.

Albida. Pure white. Per oz., 35c.; per pkt., 10c.

Rose Cardinal. One of the most effective for bedding. Per oz., 40c.; per pkt., 10c.

Mixed Colors. Special select Umbellata mixture. Price per oz., 25c.; per pkt., 5c.

Perennial. (*Iberis Sempervirens*). Hardy, low growing, compact plant; blooms early in spring in masses of pure white. Fine for border edges or cemetery planting. Price per oz., \$4.00; per pkts., 10c.

Canna.

Indian Shot.

The seed shells are very hard, and to facilitate germination it is a good plan to soak them in warm water ten to twelve hours before planting.

Dwarf Large Flowered French. The flowers range through all the shades of yellow and orange to the richest crimson, scarlet and vermilion; some are also beautifully spotted. Mixed. Price per oz., 50c.; per pkt., 10c.

Canterbury Bells.

Single Mixed. Beautiful, large, bell-shaped flowers; hardy biennials; two feet. Price per oz., 75c.; per pkt., 10c.

Double Mixed. Two feet. Price per oz., \$2.00; per pkt., 10c.

Calycanthemum. (Cup and Saucer). This is the finest variety of Campanula, producing plants with white and blue flowers, resembling cup and saucer. Single mixed. Per oz., \$2.50; per pkt., 10c.

Cardinal Climber. See *Ipomea*.

Carnation.

Carnations are general favorites for their delicious fragrance and richness of colors. The seed we offer will produce many splendid double and semi-double flowers. While not hardy like the Grenadin class and best treated as annuals they are a much better flower. 1½ feet.

Chaubaud's Improved Giant Double White. (Jeane Dionis). Price per oz., \$5.50; per pkt., 25c.

Chaubaud's Improved Giant Double Red. (Sparkler). Price per oz., \$5.50; per pkt., 25c.

Chaubaud's Improved Giant Everblooming. *Enfant DeNice*. This new strain is magnificent and so far is the last word in annual carnations. About 90% of the plants come double. Seed sown in January or February will bloom in July and continue to bloom throughout the winter if potted and grown cool. Price per oz., \$4.50; per pkt., 10c.

Castor Oil Bean. (See *Ricinus*).

Celosia or Cockscomb.

A very desirable and showy plant, producing large combs of crimson or yellow flowers. The "Cristata" sorts are the well-known Cockscombs.



CARNATION,
CHAUBAUD'S NEW EVERBLOOMING.



CENTAUREA CYANUS.

Cristata, the True Cockscomb.

Golden Beauty, Dwarf Golden Yellow. Price per ¼-oz., 50c.; per pkt., 10c.

President Thiers. One of the most dwarf of all the Cockscombs, bearing large crimson combs. Price per oz., \$4.00; per pkt., 10c.

Rosea, Dwarf. Price per ¼-oz., 50c.; per pkt., 10c.

Mixed Cristata. Choice dwarf stock. Including many colors. Price per oz., \$2.50; per pkt., 10c.

Plumosa or Feathered Cockscomb.

Plants surmounted with long feathery plumes; exceedingly handsome; height, 2¼ to 3 feet.

Thompsoni Crimson. Producing graceful feathery flower spikes, which resemble ostrich plumes. Splendid crimson; foliage bronze green. Per oz., \$1.50; per pkt., 10c.

Thompsoni Golden Improved. Golden plume, similar to above except in color. Price per oz., \$1.50; per pkt., 10c.

Childsii or Chinese Wool Flower. Different from the ordinary plumosa in that plume is more like a tuft of wool; geranium red, the size of a goose egg. Very ornamental and fine for bedding. Height, two feet. Per oz., \$2.00; per pkt., 10c.

Centaurea.

Under this heading we have the well-known Cornflower. Blue Bottle, Ragged Sailor, Bachelor's Buttons, Sweet Sultans, Dusty Miller, etc.

Cornflower.

Centaurea Cyanus.

Cyanus Double Blue. The favorite dark blue sort so much in demand for cutting. Per oz., 40c.; per pkt., 10c.

White. Per oz., 25c.; per pkt., 10c.

Rose. Per oz., 35c.; per pkt., 10c.

Mixed. Per oz., 35c.; per pkt., 5c.

Giant Sweet Sultans.

Centaurea Imperialis.

| | Oz. | Pkt. |
|---|------|------|
| Amaranth Red | 1.50 | 10c. |
| Delicate Lilac | 1.00 | 10c. |
| Deep Lavender. Very sweet scented | 1.00 | 10c. |
| Pure White. Best for cutting | 1.00 | 10c. |
| Finest Mixed Colors | 1.00 | 10c. |

Centaurea.

White-Leaved or Dusty Miller Varieties.

Valuable plants for ribbon bedding, the silvery whiteness of the leaves being very effective with other colored-leaved plants.

Gymnacarpa. Graceful, fine-cut, silvery white foliage, 1½ feet. Price per oz., 60c.; per pkt., 10c.

Candidissima. Silvery, broad-cut leaves. Price per oz., \$3.00; per pkt., 10c.

Cineraria.

A magnificent greenhouse plant having a range and brightness of color seldom equalled. Sow seeds from May to July.

Hybrida Grandiflora. Prize varieties, finest obtainable; large flowering. Semi-dwarf. Brilliant blossoms, beautifully marked colors. Price per ½-oz., \$2.50; per pkt., 25c.

Stellata Large Flowered. Handsome star-shaped flowers, free blooming. Price per ¼-oz., \$2.50; per pkt., 25c.

Maritima. (Dusty Miller). Silvery foliage. Fine for bedding, edging and ribbon planting. Price per oz., 50c.; per pkt., 10c.



ANNUAL CHRYSANTHEMUMS.

Chrysanthemums.

ANNUAL VARIETIES (Painted Daisy)

Very showy and effective garden plants, extensively grown for cut flowers. The hardy annuals are summer flowering border plants, and distinct from the autumn flowering varieties.

Burridgeanum. Single carinatum. White petals with zone of rich, brownish red and inner zone of yellow surrounding dark brown disc. Price per oz., 35c.; per pkt., 10c.

Gladstone. Large single carinatum; flowers rich velvety crimson. Price per oz., 35c.; per pkt., 10c.

Morning Star. Segatum. Pale primrose with zone of deeper yellow Award of Merit R. H. S. 1921. Price per oz., 35c.; per pkt., 10c.

Northern Star. Carinatum. White with yellow center and dark disc; large and showy. Award of Merit R. H. S., 1921. Per oz., 35c.; per pkt., 10c.

The Sultan. Carinatum Wallflower red with narrow sulphur yellow zone around a brown disc. Price per oz., 35c.; per pkt., 10c.

Carinatum Single Mixed. Priced per oz., 35c.; per pkt., 5c.

Carinatum Double Mixed. Valuable border plants providing abundance of fine double flowers for cutting during the summer; white and shades of yellow. Price per oz., 75c.; per pkt., 10c.

PERENNIAL VARIETIES.

Japanese Hybrids. Double flowered. The seed here offered has been saved from a choice early flowering strain. Seed sown in spring will flower by autumn. Price per ¼-oz., \$2.00; per pkt., 25c.

Double Early Flowering. A double and semi-double indicum of rich coloring, flowering five months after sowing. Suitable for open ground. Price per ¼-oz., \$1.00; per pkt., 25c.

Chrysanthemum Leucanthemum. (Maximum Alaska Shasta Daisy). Large, single, pure white flowers, borne on long stems. Excellent for border and cutting. Price per oz., \$1.25; per pkt., 10c.

Clarkia.

Beautiful, hardy annuals from California, with rose-colored, white and purple flowers, in delicate but very brilliant shades. The plants are about eighteen inches high and profuse bloomers.

Mixed Double. Price per oz., 85c.; per pkt., 10c.

Cleome.

The Giant Spider Plant.

Seed sown in May will commence blossoming July 1st, and continue until frost. The flowers of this variety are of the largest, making a striking appearance in the border or in masses, color rosy carmine. The stamens are several inches long, which gives it the name of Spider Flower. Five feet.

Gigantea Rose Queen. Price per oz., \$1.00; per pkt., 10c.

Clianthus.

Australian Glory Pea.

Magnificent plants which should be sown in light, rich soil. A shrubby, tender greenhouse perennial.

Dampieri. Flowers in clusters, pea-shaped; of brilliant scarlet, with black center. Price per ¼-oz., \$1.50; per pkt., 10c.

Cobaea.

A beautiful, rapid-growing, climbing plant; large, handsome, bell-shaped flowers. Sow early and plant out about June. In sowing, plant the seeds edgewise, cover lightly.

Scandens. Price per oz., 75c.; per pkt., 10c.

Cockscomb. (See Celosia).

Coleus.

A distinctive foliage plant, with large, brilliantly colored leaves, ranging through shades of scarlet, yellow, green and variegated markings. Sow early in spring.

Large-Leaved Extra Choice. Saved from finest richly colored plants of extra choice strain. Per ¼-oz., \$2.00; per pkt., 25c.

Fine Mixed. This is from choice strains, and contains richly colored assortment. Price per ¼-oz., \$1.50; per pkt., 25c.

Columbine.*(See Aquilegia).***Convolvulus.***Morning Glory.*

Major. Free flowering climber, succeeds in almost any situation. Height, fifteen feet. Fine mixed. Price per pkt., 5c.; per oz., 15c.; per lb., \$1.25.

Tricolor Minor. "Brush Morning Glories," grow only about one foot high. Price per oz., 25c.; per pkt., 5c.

Coreopsis.

Coreopsis. (See also Calliopsis). This is a fine hardy plant with large, bright yellow flowers, produced in abundance from June until frost. Valuable as a cut flower, having long stems and keeping in good condition some time. Easily grown from seed, flowering the first year, if sown early.

Lanceolata Gd. fl. Mayfield Giant. Per oz., 75c.; per pkt., 10c.

Lanceolata Gd. fl. pl. New semi-double; an excellent cut flower. Per oz., \$1.50; per pkt., 10c.

Cosmos.

An autumn plant with feathery foliage. The flowers are borne profusely in loose clusters. Seed should be sown early in the spring and the plants transplanted in the open border when danger from frost is past.

The Early Large Flowering strains are much improved over the old sort; not only larger, but beginning to flower early in July and continuing until cut off by frost.

Early Large Flowering Pink. Per pkt., 10c.; per oz., 50c.

Early Large Flowering White. Price per pkt., 10c.; per oz., 50c.

Early Large Flowering Crimson. Price per pkt., 10c.; per oz., 50c.

Early Large Flowering Mixed. Price per pkt., 10c.; per oz., 50c.

Pink Lady Lenox. Considered the finest of all late Cosmos. Flowers of gigantic size, some ranging 4½ inches across. Color is a beautiful shell pink. Price per pkt., 10c.; per oz., 50c.

White Lady Lenox. This is the same in all respects, except color, as the famous Pink Lady Lenox. Price per pkt., 10c.; per oz., 50c.

Giant Crimson. Per pkt., 10c.; per oz., 50c.

Giant Late Flowering Mixed. Our mixture includes the new White Lady Lenox. Price per pkt., 10c.; per oz., 50c.

Double Crested Mixed. (Anemone Flowered). New early flowering strain. Sometimes called double. These have double centers with rows of petals around base. Very effective; colors pink, crimson and white. Price per oz., \$3.00; per pkt., 15c.

Cucumis.

Flexuosus. (Snake Cucumber). A rapid growing vine, quite ornamental, and often attaining a length of six feet. Annual. Per oz., 60c.; per pkt., 10c.

Cyclamen.

A genus of the most beautiful and elegant winter and spring blooming plants for pot culture. If sown early in spring under glass, will make flowering bulbs in one year.

Giganteum. Extra fine strain. Flowers of an extraordinary size, broad petals and stout flower stalks. Price per ¼-oz., \$3.00; per pkt., 25c.

Cynoglossum Amabile.*Chinese Forget-me-not.*

Grown as an Annual. Flowers on beautiful blue sprays. Grows easily and blooms over a long season. Price per oz., 50c.; per pkt., 10c.

Cypress Vine.

A clinging plant with very delicate, fern-like foliage, and masses of beautiful, star-shaped flowers, borne in clusters. Half-hardy annual. Oz. Pkt.

White 50c. 10c.

Scarlet 50c. 10c.

Mixed 50c. 10c.

Dahlia.

One of our best autumnal flowering plants, blooms until killed by frost; tuberous rooted, half-hardy perennials; blooming the first year from seed, if sown early; protect the roots during winter in a dry cellar in peat moss or sand.

Large Flowering. Finest mixed, unrivalled quality. Decorative and show varieties. Saved from named varieties. Per pkt., 25c.; per ¼-oz., \$1.25.

Cactus. Double mixed. Saved from very choice stock. Large variety, with curled and pointed petals. Price per pkt., 25c.; per ¼-oz., \$1.25.

Small Flowering (Bouquet or Lilliputian). Saved from choice double flowers; mixed colors. Price per ¼-oz., \$1.25; per pkt., 25c.

Single Mixed. Giant Perfection. Very fine; large showy flowers. Per oz., \$1.00; per pkt., 10c.

Coltness Hybrids. A splendid new class of Single Dahlias. The plants are of neat, compact habit, averaging 18 inches high, carrying the flowers of varied colors well above the foliage. Extremely attractive for garden or park decoration. Price per ¼-oz., 75c.; per pkt., 25c.



COSMOS, EARLY LARGE FLOWERING.

Datura.

Trumpet Flower.

Robust ornamental annuals, with large and showy flowers, 2 to 3 feet high.

Double Golden. Deep yellow; delightfully fragrant. Price per oz., 50c.; per pkt., 10c.

Cornucopia. ("Horn of Plenty"). A grand variety; the flowers average 8 inches long by 5 across; French white inside, purple outside; delightfully fragrant; started early will flower from early summer until fall. Per oz., 50c., pkt., 10c.

Delphinium.

Hardy Perennial Larkspur.

Seed may be sown any time from spring till fall. Sow in fine soil, 1/8-inch deep. Seed germinates in about 15 days. Keep moist and shaded until well rooted. Seed sown early spring will give some bloom first year; be in prime the second year.

Hybrids. Platt's Special. For a number of years a specialist has been carefully collecting and selecting delphinium varieties with a view to making a mixture which would contain all the most beautiful shades of color obtainable in a perfect blend. This includes the famous Wrexham and Vanderbilt types that produce such magnificent spire-like spikes of color, from deepest blue through bright blue, mauve and pastel shades. We offer in following color groups: **Light Blue Shades, Deep Blue Shades, Mid-Blue Shades, Pastel Shades. All Shades Mixed.**

Each of above: per 1/4-oz., \$1.00; per pkt., 25c. Any 5 pkts., \$1.00.

Wrexham. Hollyhock type. A magnificent, very superior strain. Enormous spikes of single and double blooms, including all shades of blue. Price per 1/8-oz., \$1.50; per pkt., 50c.

Belladonna Improved. (Cliveden Beauty). This is called the Everblooming Hardy larkspur; in addition, is of the finest type, lovely light blue; height 3 ft. Per 1/4-oz., \$1.75; per pkt., 25c.

Bellamosum. Deep blue, Belladonna type. Price per 1/4-oz., \$1.00; per pkt., 25c.

Formosum. Deep blue, white center; 2 to 3 feet. Price per 1/4-oz., \$3.00; per pkt., 25c.

Formosum Coelestinum. Long spikes of sky-blue flowers, with white center. Price per 1/4-oz., \$3.00; per pkt., 25c.

Chinensis. Cambridge Blue. New. (Annual). Surpassing Belladonna in brilliancy; height 2 to 3 feet. A great cut flower. Price per 1/4-oz., \$1.00; per p.t., 25c.

Dianthus.

This class of pinks are usually treated as hardy annuals. They flower early in summer and continue until frost; excellent for small beds or edgings, flowering profusely. Hardy biennial.

Chinensis Fl. Pl. (Chinese or Indian Pink). The double flowers are produced in great variety of colors; very free flowering. Mixed. 1 foot. Price per oz., 50c.; per pkt., 10c.

Heddewigii Lacinatus Fl. Pl. (Japanese Pink). Large flowering, double choicest mixed, extra fine, colors vary from rich crimson to delicate pink. Price per oz., 75c.; per pkt., 10c.

Heddewigii (Japanese Pink). Single, finest mixed. Price per oz., 60c.; per pkt., 10c.

Fireball. Large, double, brilliant scarlet. 1 foot. Price per oz., \$1.50; per pkt., 10c.

Snowball. Large, double, fringed pure white. 1 foot. Price per oz., 75c.; per pkt., 10c.

Diadematus Double Mixed. Large double flowers, great variation of colors. Edges fringed. 1 foot. Price per oz., 75c.; per pkt., 10c.

Mourning Cloak or White Frill. The flowers are very rich maroon color, margined white. It has a rich clove fragrance. Per oz., \$1.00; per pkt., 10c.

HARDY PERENNIAL VARIETIES.

Highly valued for beauty and fragrance of their flowers. These make splendid bushy plants, one to two feet high, for permanent beds and borders.

Plumaris (Grass Pink or Pheasant-eye Pink). A single hardy. Pink, with fringe-edged white flowers, with dark center. Per oz., \$1.00; per pkt., 10c.

Plumaris Fl. Pl. Mix d (Double Pheasant's Eye Pink). Spicy clove fragrance. Double fringed flowers of white, crimson or purple shades, spotted and variegated. Price per oz., \$1.50; per pkt., 10c.

Semperflorens (Everblooming Hardy Garden Pink). Very beautiful sweet scented, double, semi-double and single flowers. Price per oz., \$3.00; per pkt., 10c.

Didiscus. Blue Lace Flower.

This beautiful annual came recently from Australia and has become very popular. Blooms profusely from July until frost. An excellent cut flower. Price per oz., \$1.75; per pkt., 10c.

Digitalis. Foxglove.

Ornamental plants of stately growth, bearing long spikes of large, showy flowers, running through shades of white, rose, yellow and purple. Fine for shrubberies and half-shady places. Hardy perennial.

Gloxiniaeflora Mixed. Long spikes with beautiful Gloxinia-like flowers. Per oz., \$1.00; per pkt., 10c.

The Shirley. Finest strain of digitalis yet introduced; giant spikes of finest colors. Per oz., \$1.25; per pkt., 10c.

Dimorphotheca.

African Daisy.

Aurantiaca. Golden. Per oz., \$1.50; pkt., 10c.

Aurantiaca Hybrids Mixed. Price per oz., \$1.50; per pkt., 10c.

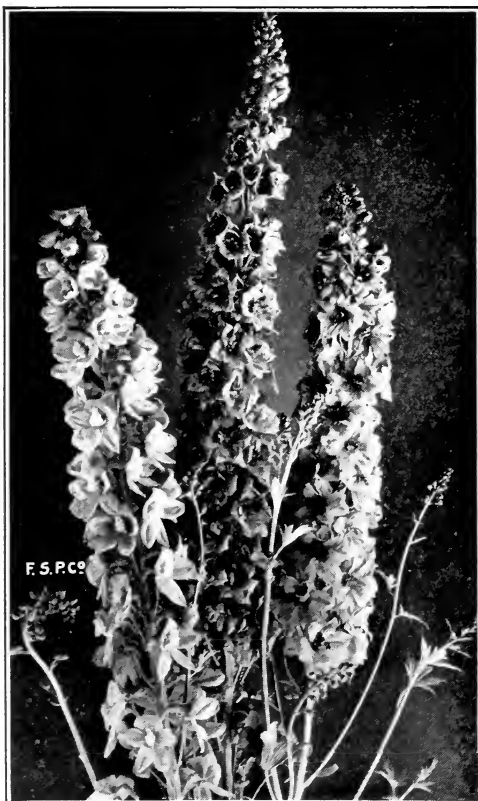

DELPHINIUM HYBRIDS, PLATT'S SPECIAL.

Dracaena.

Decorative plants with long, narrow leaves, suitable for center plants in vases, baskets, etc.

Indivisa. Price per oz., 75c.; per pkt., 10c.

Edelweiss.

Gnaphalium Leontopodium.

The famous Edelweiss of the Alps. The flowers are star-shaped, of downy texture, and pure white, and are sought after as souvenirs. They retain their natural appearance for years. Price per 1/8-oz., \$5.00; per pkt., 10c.

Eschscholtzia.

California Poppy.

An annual of easy culture. Seeds sown early will come into bloom in June and continue until frost.

Aurantiaca. Rich orange. True California poppy. Award of Merit R. H. S. 1930. Price per oz., 30c.; per pkt., 10c

Carmine King. Deep carmine. Per oz., 60c.; per pkt., 10c.

Crome Queen. Amber yellow. Per oz., 50c.; per pkt., 10c.

Hunnemannia. Bush eschscholtzia. One and one-half feet high, of bushy habit, have large buttercup yellow, poppy-like blossoms. Price per oz., 75c.; per pkt., 10c.

Salmon Beauty. New. Beautiful salmon inside and out. Exhibited for first time and received Award of Merit R. H. S. 1930. Per oz., \$2.50; per pkt., 10c.

Scarlet Beauty. Deep scarlet. Per oz., \$1.25; per pkt., 10c.

The Geisha. Inside petals brilliant gold, outside orange-crimson; petals fluted. Per oz., \$1.25; per pkt., 10c.

Hybrida Mixture. Made up of new colors in Eschscholtzia, including soft pink, scarlet, crome copper-red, claret and royal purple. Per oz., \$1.00; per pkt., 10c.



EUPHORBIA VARIEGATA.

Euphorbia.

Marginata Variegata (Snow on the Mountain). The leaves are light green and margined white. Price per oz., 50c.; per pkt., 10c.

Mexican Fire Plant or Fire on the Mountain. In habit and appearance resembling the poinsett-

tia. The plants grow 2 to 3 feet high, of branching, bush-like form, with glossy leaves, but about mid-summer become orange-scarlet, presenting a striking and brilliant appearance. Price per oz., \$1.50; per pkt., 10c.

Feverfew.

Matricaria.

Free-flowering plants, succeed in any garden soil; hardy annual, blooming the first season if sown early.

Alba Plenissima Double White. Seeds saved from fine double flowers. 18 inches high. Price per oz., 75c.; per pkt., 10c.

Forget-Me-Not.

(See *Myosotis*.)

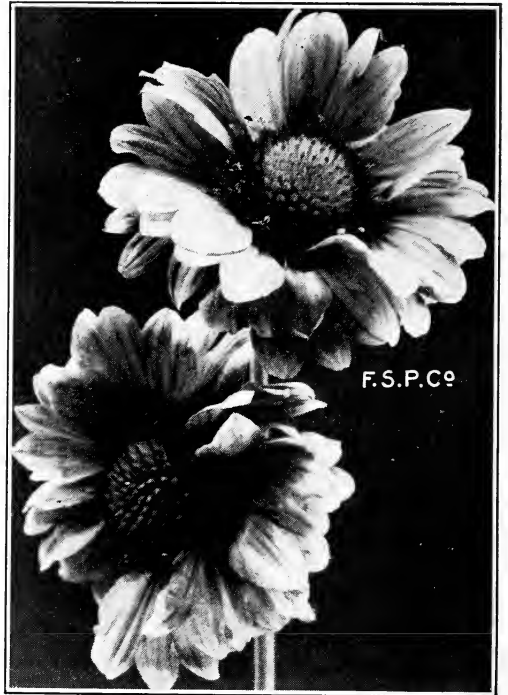

GAILLARDIA—GRANDIFLORA DAZZLER.

Gaillardia.

Showy and universally admired annual, flowering the first year; among the gayest ornaments of summer flower beds.

Picta Indian Chief. New bronzy-red. Single annual. Per oz., 60c.; per pkt., 10c.

Picta Lorenziana A charming profuse double flowering strain; mixed colors. Annual. Price per oz., 75c.; per pkt., 10c.

Picta Fine Mixed. Single; annual. Price per oz., 50c.; per pkt., 10c.

HARDY PERENNIAL VARIETIES.

Grandiflora Dazzler. Golden yellow, maroon center. Price per oz., \$2.00; per pkt., 10c.

Grandiflora Sanguinea. Rich crimson with yellow border. Price per oz., \$1.25; per pkt., 10c.

Grandiflora Compacta Mixed. Bushy plants 12 to 15 inches, flowers long-stemmed and above foliage. Price per oz., \$1.00; per pkt., 10c.

Grandiflora Portola Hybrids. (New). Varied rith shades of red, tipped golden. Strong grower, compact habit, long stems. Price per 1/4-oz., 75c.; per pkt. 15c.

Geranium.

Single Mixed Zonale. Including many varieties. Price per oz., \$3.00; per pkt., 10c.

Double Mixed Zonale. Excellent quality. Price per ½-oz., \$1.25; per pkt., 25c.

Pelargonium (Lady Washington). Desirable plants for pot culture; the flowers are borne in clusters, are rich and beautifully marked. Price per ½-oz., \$3.00; per pkt., 25c.

Apple Scented. Fragrant foliage. Price per ½-oz., \$1.25; per pkt., 25c.

Gilia.

Hardy annual, grows in almost any situation; profuse bloomers and fine for rockeries.

Tricolor Mixed. Price per oz., 25c.; per pkt., 10c.

Capitata. (Queen Ann's Thimble). Annual. Very pretty bright blue, thimble-shaped flowers in clusters. Height 18 inches. Price per oz., 25c.; per pkt., 10c.

Globe Amaranth.

"Bachelor's Buttons." Garden annuals, forming bushy plants about two feet high and bearing a great many flowers, purple, white, striped, etc.; very desirable "Everlastings."

White. Price per oz., 50c.; per pkt., 10c.
Flesh Color. Price per oz., 50c.; per pkt., 10c.
Mixed Colors. Price per oz., 50c.; per pkt., 10c.

Godetia.

Satin Flower.

Very showy annual. The new improved, tall, double, grandiflora type. Grows 1½ to 2 feet and produce fine long trusses. Excellent for cutting.

| | Oz. | Pkt. |
|---|------|------|
| Grandiflora Double Crimson | 75c. | 10c. |
| Grandiflora Mauve | 75c. | 10c. |
| Grandiflora Rosy Morn. Bright pink | 75c. | 10c. |
| Grandiflora Mixed | 75c. | 10c. |

Gourds.

A very ornamental class of rapid growing climbers. The fruit is of curious shapes, sizes and colors. All are hard shelled and will keep indefinitely.

Nest Egg. A capital nest egg. Produces fine white fruits, egg shaped. Per oz., 30c.; per pkt., 10c.

Orange. Dark yellow and orange shaped. Price per oz., 30c.; per pkt., 10c.

Hercules' Club. Club shape. Grows 4 feet in length. Price per oz. 30c.; per pkt. 10c.

Dipper. Used as a dipper. Oz., 30c.; per pkt., 10c.

Dish Cloth. A vegetable dish cloth; tough and elastic. Fruit 2 feet in length. Oz., 30c.; per pkt., 10c.

Sugar Trough. This variety grows to a large size. Price per oz., 30c.; per pkt., 10c.

Calabash or Pipe Gourd. Grown extensively for use in making pipes. Price per oz., 30c.; per pkt., 10c.

Bottle. Resembles a bottle. Price per oz., 30c.; per pkt., 10c.

Turk's Turban. Striped mixed. Price per oz., 25c.; per pkt., 10c.

Fancy and Ornamental. Small mixed varieties. Price per oz., 25c.; per pkt., 5c.

Large Mixed. Large sized varieties. Price per oz., 25c.; per pkt., 5c.

Grasses--Ornamental.

For winter decoration these are very beautiful and should be cut before they are thoroughly ripe. Transplant as soon as they can be handled. This will allow them to develop their character.

Agrostis Nebulosa (Cloud Grass). Annual. 18 inches high. A graceful airy sort used in the border and bouquets. Price per oz., \$1.25; per pkt., 10c.

Briza Maxima (Quaking Grass). Annual, height 18 inches, for winter bouquets. Price per oz., 50c.; per pkt., 10c.

Coix Lachrymae (Job's Tears). Annual, 2 to 3 feet tall. Price per oz., 20c.; per pkt., 10c.

Eragrostis Elegans (Love Grass). Annual, 18 inches. Used for bouquets. Spikelets small and airy. Price per oz., 50c.; per pkt., 10c.

Eulalia (Japonica Variegata). Hardy perennial, 6 feet. Long green leaves, cross striped white, fine for groups. Useful for bold effects. Price per oz., \$1.00; per pkt., 10c.

Gynerium Argenteum (Pampas Grass). Perennial with large silvery plumes. Height 6 feet. Price per oz., 75c.; per pkt., 10c.

Pennisetum Rupeelianum. (Fountain Grass). Perennial but treat as annual. Graceful, deep green foliage, long purplish plumes. Sow in March inside and transplant in May to bloom in July. Old roots may be wintered over in cool house for Spring propagation. Allow 18 inches between plants. Price per oz., \$1.25; per pkt., 10c.

Stipa Pennata (Feather Grass). Perennial with silver-white plumes. Height 2 feet. Price per oz., \$3.50; per pkt., 20c.

Gypsophila. Baby's Breath.

Delicate free-flowering plants covered with a profusion of fine star-shaped flowers.

Gypsophila Paniculata. Sprays of delicate little white flowers. Hardy. Perennial. Per oz., 60c.; per pkt., 10c.

Paniculata Alba Double. New, snow white, fine for cutting, lasts better than single. Price per ½-oz., \$1.50; per pkt., 25c.

Grandiflora Alba. Annual. Paris Market. Improved large flowering. Pure white. Beautiful in combination with other flowers. Make several sowings to keep up supply through season. Price per oz., 30c.; per pkt., 10c.

Muralis. Small pink flowered, annual, for rock gardens and borders. Per oz., \$1.00; per pkt., 10c.



HELICHRYSUM MONSTROSUM.

Helichrysum. Straw Flower.

Bright and attractive summer blooming annuals of free growth and producing in abundance large double red, white and yellow flowers; valuable as an "Everlasting." The following are new improved large double flowering.

Yellow Monstrosum. Per oz., \$1.00; per pkt., 10c.
Fireball Monstrosum. Per oz., \$1.00; per pkt., 10c.
Silvery Pink Monstrosum. Per oz., \$1.00; per pkt., 10c.

Monstrosum Mixed Large Flowering. Double, Price per oz., 75c.; per pkt., 10c.

Heliotrope.

A half-hardy perennial, flowering during the whole season; deliciously fragrant and a splendid bedding plant. Seeds sown in the spring will make fine plants for summer blooming.

Regal. Dwarf, fine, improved variety. Large masses of bloom, all shades. Price per oz., \$4.00; per pkt., 15c.

Lemoines' Large Flowering Mixed. All colors of the Giant type. Price per ¼-oz., 50c.; per pkt., 10c.

Helianthus or Sunflower.

Tall growing plants, with large and showy yellow flowers. Hardy annuals.

SINGLE VARIETIES.

Augustifolius (Autumn Glory). Produces great numbers of small, single blooms suitable for cutting. Per oz., \$1.00; per pkt., 10c.

Red Hybrids. Miniature type in various shades. Price per oz., 50c.; per pkt., 10c.

Stella. Improved miniature. Branching habit. Flowers from two to three inches in diameter, with black centers. Price per oz., 50c.; per pkt., 10c.

Orion. New variety of Stella strain; petals twisted like cactus dahlia. Per oz., 50c.; per pkt., 10c.

Argyrophyllus. Plants usually 4 to 5 feet high, silvery foliage, flowers small, with dark centers. Price per oz., 30c.; per pkt., 10c.

Mammoth Russian. Grows 8 to 12 feet high, bearing single heads measuring from 15 to 18 inches in diameter. Price per oz., 10c.; per pkt., 5c.

DOUBLE VARIETIES.

Chrysanthemum. Very fine, double, golden yellow with fringed petals, 5 feet. Price per oz., 25c.; per pkt., 5c.

Globosus Fistulosus. (Globe or Dahlia Sunflower). Flowers large rich saffron color. 6 feet. Per oz., 25c.; per pkt., 5c.

New Giant Hibiscus.

Marshmallow.

Showy ornamental perennials, for mixed beds or shrubby borders, having large-sized, beautifully colored flowers; blooms the first year if sown early. Height 5 to 8 feet.

Hybrids Mixed. A new race of large flowering hybrids including beautiful shades of reds, pinks, white, blush and rose. Per oz., 85c.; per pkt., 10c.

Sunset or Golden Bowl. More tender than hybrids, best treated as an annual; start indoors in individual pots. The large flowers with maroon centers are very beautiful. Per oz., \$1.00; per pkt., 10c.

Hyacinth Bean.

Dolichos.

Annual climber, producing clustered spikes of purple and white flowers, followed by exceedingly ornamental seed pods.

Daylight. Large wistaria-like racemes of snow-white, sweet-scented flowers, followed by silvery white seed pods. Price per oz., 30c.; per pkt., 10c.

Darkness. Similar to above, except in color which is a rich purple-violet. Per oz., 30c.; per pkt., 10c.

Lablab Mixed. Price per oz., 25c.; per pkt., 10c.



CHATER'S HOLLYHOCK.

Hollyhock.

For majestic growth and massive beauty the hollyhock stands unrivaled. Flowers very large, perfectly double, and of great variety of color.

Chater's Dark Crimson. Per ¼-oz., 75c.; per pkt., 10c.

Chater's Newport Pink. Per ¼-oz., 75c.; per pkt., 10c.

Chater's Salmon Rose. Per ¼-oz., 75c.; per pkt., 10c.

Chater's Sulphur Yellow. ¼-oz., 75c.; per pkt., 10c.

Chater's White. Per ¼-oz., 75c.; per pkt., 10c.

Extra Choice Double Mixed. Chater's strain. Per ¼-oz., 50c.; per pkt., 10c.

Imperator New distinct type with a double center rosette; the wide, outer petals are frilled and fringed. Assorted colors. ¼-oz., 75c.; per pkt., 10c.

"Allegheny" Single Fringed Mixed. Mammoth flowers, wonderfully formed of loosely arranged fringed petals. Per oz., 75c.; per pkt., 10c.

Annual. Single and double mixed. Perpetual flowering, bushy habit, 3 feet. If sown early blooms same year. Per ¼-oz., 35c.; per pkt., 10c.

Honesty (Lunaria Biennis).

White flowers followed by silvery seed pods. (Peter's Penny). Popular for winter bouquets. Sow seed in fall or spring. Price per oz., 60c.; per pkt., 10c.

Humulus.

Japanese Hop.

Japonica. The foliage is very dense, and in color a lively green. Per oz., 60c.; per pkt., 10c.

Variegated. A variegated variety with green and white leaves. Per oz., 60c.; per pkt., 10c.

Ice Plant.

Suitable for rock work, hanging baskets, etc. Foliage thick, flowers frosted, wax-like.

Mesembryanthemum. Per oz., 50c.; per pkt., 10c.

Impatiens.

Holstii Hybrids. Strong, bushy plants, about 2 feet high; covered with flowers throughout the season. When grown as a pot plant they bloom the year round. Mixed. Per ¼-oz., \$1.00; per pkt., 15c.

Ipomea.

This is a rapid and luxuriant summer climber, profuse in its blooms of large, beautiful flowers, and invaluable.

Imperial Japanese. Handsomest of all Morning Glories. The flowers are of gigantic size, and the coloring beyond description, ranging from snow-white to black purple. Mixed. Per oz., 25c.; pkt., 10c.

Rubra Coerulea (Heavenly Blue). Immense flowers of bright sky-blue. Per oz., \$1.00; pkt., 10c.

Bona Nox (Evening Glory). Large, blue, fragrant flowers. Price per oz., 60c.; per pkt., 10c.

Grandiflora Alba (Moon Flower). At night and during dull days the plants are covered with an abundance of large, pure white, fragrant flowers, 5 to 6 inches in diameter. Grows very rapidly. Price per oz., 60c.; per pkt., 10c.

Quamoclit Hybrid (Cardinal Climber). One of the finest annual climbers, 20 to 25 feet, flowers size of half-dollar, intense scarlet. Seed should be notched or soaked to aid germination. Price per oz., \$1.50; per pkt., 15c.

Kenilworth Ivy.

Linaria Cymbalaria.

A violet flower, neat, hardy perennial trailing plant, suitable for baskets, vases and rock work. Price per 1/4-oz., \$1.00; per pkt., 10c.

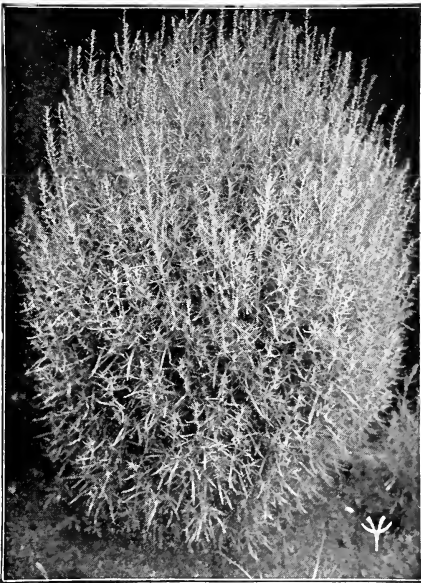

Kochia.

Summer Cypress.

Tricophylla. Improved Childsii. An easily-grown annual with perfect symmetry. It is a lively green, but on the approach of autumn the whole plant becomes a bright scarlet, making in all a very desirable plant. During the summer it obtains a height of about 3 feet. Per oz., 35c.; per pkt., 10c.

Kudzu Vine.

Pueraria Thunbergiana.

A twining vine of remarkably rapid growth, attaining a length of 40 to 50 feet in one season. Hardy, though the vine dies down every winter. Foliage large and lobed, purple, pea-shaped flowers in clusters. A fine vine for arbors, verandas, etc. Price per oz., 50c.; per pkt., 10c.

Lantana.

A most desirable half-hardy, greenhouse or bedding plant, constantly in bloom; verbena-like heads of orange, white, rose and other colored flowers.

Finest Mixed. Price per oz., 75c.; per pkt., 10c.

Larkspur Annual.

Delphinium.

Beautiful, hardy annuals, producing dense spikes of flowers, which are very ornamental, either in the garden or when cut for vases. Set 10 inches apart. Sow seed either late fall or early spring. The new Imperial upright type is a great advance in Larkspurs.

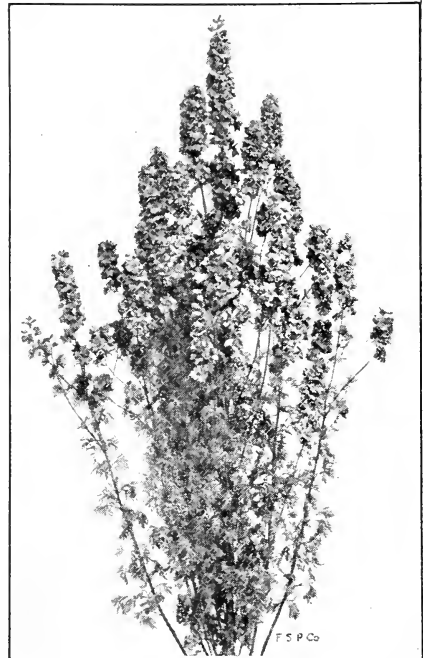

| | Oz. | Pkt. |
|---|--------|------|
| Blue Spire (new 1931). Intense, deep Oxford Blue with upright base branching habit which has made this type so popular. | \$2.00 | 15c. |
| Exquisite Pink Improved. Soft salmon | 1.25 | 15c. |
| Gloria. Giant Imperial. A rich tone of deep rose with no trace of carmine. Better than Exquisite Rose.. | 4.00 | 25c. |
| Lilac Spire. New type. Beautiful color | 2.00 | 15c. |
| Los Angeles. Novelty 1930. Brilliant rose pink | 1.50 | 15c. |
| Peach Blossom. New Giant Imperial. Clear light pink | 4.00 | 25c. |
| Imperial Mixed Colors. New type ... | 1.25 | 10c. |

Lathyrus.

Everlasting Peas.

Showy, free-flowering plant, very ornamental on trellis work. Blooms excellent for cutting. Hardy perennial. 5 to 6 feet.

| | Oz. | Pkt. |
|--------------------------------------|--------|------|
| Latifolius, White Pearl | \$1.75 | 10c. |
| Lotifolius, Pink Beauty | 1.25 | 10c. |
| Latifolius, Red | 1.25 | 10c. |
| Mixed | .75 | 10c. |

Lavender.

Lavender Vera.

Slender spikes of lavender flowers, very fragrant. Hardy perennial. Per oz., 60c.; per pkt., 10c.

Linum. *Flowering Flax.*

A showy bedding plant of the flax family, having brilliant flowers of various colors, borne on slender stems, with fine foliage. Hardy annual.

Grandiflorum Rubrum. (Scarlet Flax). Annual; bright scarlet. Price per oz., 50c.; per pkt., 10c.

Blue Perenne. Perennial. Bright blue. 24 inches. Price per oz., 75c.; per pkt., 10c.

Lobelia.

The following dwarf and trailing varieties of this popular and beautiful flowering plant are desirable for pot culture, edgings, hanging baskets, etc., blooming profusely from June to November. Half-hardy annual.

TRAILING VARIETIES,

for Baskets, Vases, etc. Six to nine inches.

Gracilis. Light blue; long slender, trailing stems. Price per oz., \$2.00; per pkt., 10c.

Speciosa. Deep blue, dark foliage, trailing. Price per oz., \$2.00; per pkt., 10c.

COMPACTA VARIETIES,

for Edging, etc. Four to six inches.

Crystal Palace. Dark blue; fine for bedding. Price per 1/8-oz., 50c.; per pkt., 10c.

Emperor. Compact, bright blue. Price per 1/4-oz., 75c.; per pkt., 10c.

White Gem. Pure white. 1/4-oz., \$1.00; pkt., 10c.

Compacta Mixed. Price per oz., \$3.00; pkt., 10c.

Lupinus.

Many of the varieties are of a stately, robust growth, valuable for mixed flower and shrubby borders.

Hartwegii Annual Mixed. Rich and various new colors. Two feet. Per oz., 25c.; pkt., 10c.

Downer's Hybrids. (New). Hardy perennial variety, in fine range of colors, many new to Lupinus, flowering first year from seed. Oz., 60c.; pkt., 10c.

Lychnis.

Viscaria Splendens (Catchfly). Rosy carmine. Fifteen inches. Price per oz., 75c.; per pkt., 10c.

Chalcedonica. Brilliant orange, scarlet, Maltese Cross (Jerusalem Cross), 2 to 3 feet. Price per oz., \$1.00; per pkt., 10c.

Maurandia.

Beautiful rapid-growing climbers, blooming profusely until late in the autumn; also fine for the conservatory or greenhouse. A half-hardy perennial, flowering first season if sown early; 10 feet.

Barclayana Mixed. Blue and white mixed. 1/8-oz., 75c.; pkt., 10c.

Marigold.

A popular hardy annual of vigorous growth, producing a magnificent display of yellow, orange and maroon flowers.

AFRICAN VARIETIES.

Orange Alldouble. New 1930 strain coming 95% true. This is a great advance over the old, now superceded, in which 50% double was considered good. Price per 1/4-oz., \$1.00; per pkt., 15c.

Lemon Alldouble. Offered first time this year. Like Orange Alldouble comes 95% true, therefore we have discarded the old strain. Price per 1/4-oz., \$1.00; per pkt., 15c.

Large African. Double, tall mixed, especially fine large quilled type, orange and lemon shades, two to three feet. Price per oz., 60c.; per pkt., 10c.

FRENCH VARIETIES.

Josephine. Single brown and gold, long stems fine for cutting, height two feet. Price per oz., 50c.; per pkt., 10c.



MARIGOLD—DOUBLE TALL AFRICAN.

Legion of Honor. A dwarf single variety. Blooms early and until late in the fall. Flowers rich golden yellow, marked velvety brown. Price per oz., 60c.; per pkt., 10c.

Guinea Gold. New distinct type. Plant of graceful habit, 2 to 2 1/2 feet. Flowers semi-double, beautiful rich golden color on good stems; excellent for cutting or in border. Admired by all who saw it in 1931 trials. Price per 1/8-oz., 50c.; per pkt., 25c.

Golden Ball. Dwarf French. Very compact. Price per oz., 60c.; per pkt., 10c.

Robert Beist. Dwarf double. Dark maroon. Very fine rich color. Price per oz., 75c.; per pkt., 10c.

Dwarf, Golden Striped. Double, velvety maroon, striped gold. Price per oz., 75c.; per pkt., 10c.

French Double Dwarf Mixed. Price per oz., 50c.; per pkt., 10c.

French Tall Double Mixed. A combination of the best varieties, including new sorts; excellent for cutting; height two feet. Per oz., 50c.; pkt., 10c.

Marvel of Peru.

Four O'Clock.

Of branching habit, bearing hundreds of flowers during the season, of white, yellow, crimson and violet; some varieties combining two or more of these colors. Two feet.

Marvel of Peru or Four O'Clock. Mixed. Price per oz., 20c.; per pkt., 5c.

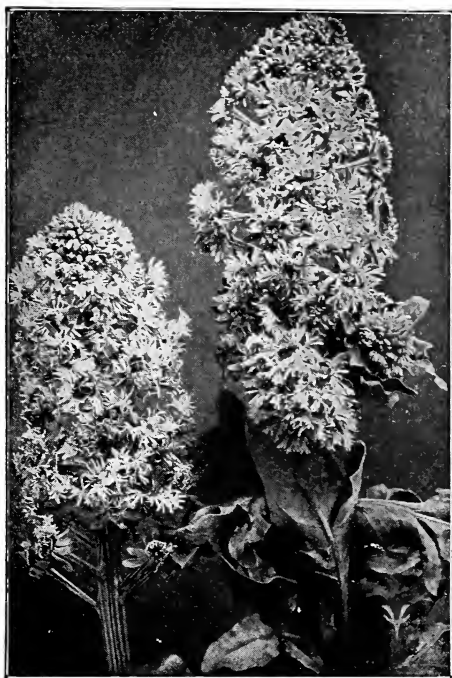

MIGNONETTE.

Mignonette.

A hardy annual, producing dense spikes of exceedingly fragrant flowers. If sown at intervals in spring and early summer will bloom until killed by frost. The machet types are continuous blooming.

Bismark. An improved machet, long red spikes, delicious fragrance. Per oz., \$1.00; per pkt., 10c.

New York Market. A magnificent large florists' strain of machet for greenhouse or outside. Price per oz., \$1.25; per pkt., 10c.

Machet Orange Queen. Beautifully colored, immense spikes, true machet type. Excellent variety for general uses. Per oz., 60c.; per pkt., 10c.

Red Goliath. Immense spikes of double red flowers. Price per oz., \$1.25; per pkt., 10c.

Machet White Pearl. Large spikes, the best white, very fragrant. Per oz., \$1.25; per pkt., 10c.

Mimosa. Sensitive Plant.

Pudica. Curious and interesting annuals, with pinkish-white flowers; the leaves close and droop when touched or shaken. One and one-half feet. Price per oz., 60c.; per pkt., 10c.

Mimulus. Monkey Flower.

Bushy plants one foot high. Flowers various shades of yellow, spotted and marked crimson.

Tigrinus. Gd. Mixed and spotted varieties. Price per 1/8-oz., 75c.; per pkt., 10c.

Moschatus (Musk Plant). Foliage emits a strong musky perfume; flowers canary yellow. Price per 1/2-oz., 75c.; per pkt., 10c.

Mina.

Lobata. Half-hardy, climbing annual. The buds are red, but turn to orange-yellow before they open. The flowers are of a creamy white. Price per oz., \$4.00; per pkt., 10c.

Moon Flower.

(See *Ipomea*).

Mormordica.

Annual climbers, with ornamental foliage, fruit golden yellow, warted, and when ripe, opens, showing the seeds and its brilliant carmine interior. Height, 10 to 15 feet.

Balsamina. Apple-shaped fruit. Price per oz., 60c.; per pkt., 10c.

Charantia. Pear-shaped fruit. Price per oz., 60c.; per pkt., 10c.

Morning Glory.

(See *Convolvulus* and *Ipomea*).

Myosotis.

Forget-Me-Not.

A well-known plant, bearing clusters of star-like flowers, best adapted to moist situations, though growing in almost any soil. Half-hardy perennial. Sown early will flower same season. Sow in cold frames July or August for early spring blooms. The *Alpestris* and *Dissitiflora* flower in April, the *Palustris* in May and continue until fall.

Alpestris Royal Blue. Rich blue, with long stems. Height 9 inches. Price per 1/4-oz., 40c.; per pkt., 10c.

Alpestris Victoria. Improved compact plant with large azure blue flowers in clusters. Price per oz., \$2.00; per pkt., 10c.

Ruth Fischer. True Forget-Me-Not blue. Plant of compact, vigorous growth; exceptionally fine for pot culture or Spring bedding. Price per 1/4-oz., \$2.50; per pkt., 15c.

Dissitiflora. Dwarf, compact, early, beautifully adapted to planting among spring flowering bulbs. Large flowering, dark blue, flowers in clusters, one of the best. Price per 1/8-oz., \$1.00; per pkt., 10c.

Palustris Semperflorens. True marsh forget-me-not. A dwarf forget-me-not, always in bloom. Blue, 6 to 8 inches. Per 1/8-oz., 50c.; per pkt., 10c.

Myrsiphyllum.

(See *Smilax*).

Nigella.

Love in a Mist, or Devil in a Bush.

A compact, free-flowering plant, with finely cut foliage, curious flowers and seed pods. Hardy annual. One foot.

Damascena. Blue and white mixed. Price per oz., 30c.; per pkt., 10c.

Miss Jekyll. A splendid variety with corn-flower blue blossoms; excellent for cutting. Price per oz., 30c.; per pkt., 10c.

Nicotiana.

Desirable plants of the tobacco family, valuable for their long duration and freedom of bloom. Half-hardy annuals.

Affinis. Flowers large, white, fragrant, and fully expanded in evening or cloudy days. Price per oz., 75c.; per pkt., 10c.

Sanderae Crimson King. Dark velvety crimson red. Price per 1/4-oz., \$1.00; per pkt., 10c.

Sylvestris. Similar to *Affinis*; leaves larger, plants pyramidal. Flowers pure white, fragrant. Used with other plants or by itself. Per oz., 75c.; per pkt., 10c.

Nemophila.

A charming class of dwarf-growing, free-flowering hardy annuals of spreading habit, preferring partial shade and moist ground.

Marginata. Azure blue, edged with white. Price per oz., 35c.; per pkt., 10c.

Finest Mixed Colors. Per oz., 35c.; per pkt., 5c.



Nasturtium.

Tropaeolum.

Most Brilliant of Annuals.

Nasturtiums are one of our most popular and brilliant annuals. The neat, ornamental foliage and bright flowers produced in profusion until cut by frost, makes them useful in any garden. Tall, as well as dwarf sorts, may be used for bedding. Dwarf named sorts best for edging because of uniformity. They will thrive in poor soil, requiring almost no care, as culture is very easy. Sow seed outside when ground is WARM. If plants become infested with black lice, spray with Red Arrow Pyrethrum Spray or Nicotine.

DWARF VARIETIES.

Aurora. Cream yellow, veined with carmine. Price per oz., 20c.; per pkt., 5c.

DWARF VARIETIES

—Continued.

Beauty. Yellow, striped with red. Price per oz., 20c.; per pkt., 5c.

Cloth of Gold. Scarlet flowers with golden yellow foliage. Price per oz., 20c.; per pkt., 5c.

Crystal Palace Gem. Sulphur yellow, spotted maroon. Price per oz., 20c.; per pkt., 5c.

Empress of India. Very dark green foliage; flowers bright crimson. Price per oz., 20c.; per pkt., 5c.

Golden King. Pure bright yellow, dark leaved. Price per oz., 20c.; per pkt., 5c.

King of Tom Thumbs. Intense scarlet, dark foliage. Price per oz., 20c.; per pkt., 5c.

King Theodore. Deep maroon flowers and dark foliage. Price per oz., 20c.; per pkt., 5c.

Pearl. Creamy white. Price per oz., 20c.; per pkt., 5c.

Rose. Dark pink. Price per oz., 20c.; pkt., 5c.

Dwarf Special Mixed. All best colors. An exceedingly attractive high quality well-blended mixture. Price per lb., \$1.50; per ¼-lb., 40c.; per oz., 15c.; per pkt., 5c.

NEW DOUBLE NASTURTIUM NOVELTY.

Golden Gleam. A double, sweet-scented, semi-trailing type. It was discovered in Mexico by Mr. John Bodger who sent us 12 seeds in Spring of 1931 for trial. These were grown in pots and shown for the first time and admired by all who saw them. The color is a most pleasing golden yellow. It was very favorably reported on by others favored with advance samples in Europe, South Africa and various parts of the United States. Price per oz., \$1.50; per pkt., 25c.

TALL VARIETIES.

King Theodore. The deepest and richest dark crimson nasturtiums, having a soft, velvety texture. Price per oz., 20c.; per pkt., 5c.

Jupiter. Mammoth flowers; of a rich golden yellow. Price per oz., 20c.; per pkt., 5c.

Vesuvius. A most desirable variety with flowers of a salmon rose. Price per oz., 20c.; per pkt., 5c.

Schulzi. A rich scarlet; dark leaved. Price per oz., 20c.; per pkt., 5c.

Moonlight. Large flowers of clear, pale lemon color. Price per oz., 20c.; per pkt., 5c.

Twilight. Very large flowers of delicate salmon, marked with rose. Price per oz., 20c.; per pkt., 5c.

Butterfly. Light yellow, marked with red. Price per oz., 20c.; per pkt., 5c.

Mixed Tall Varieties. This mixture is extra choice containing a wide variety of the finest in color and size. Price per lb., \$1.25; per ¼-lb., 35c.; per oz., 15c.; per pkt., 5c.

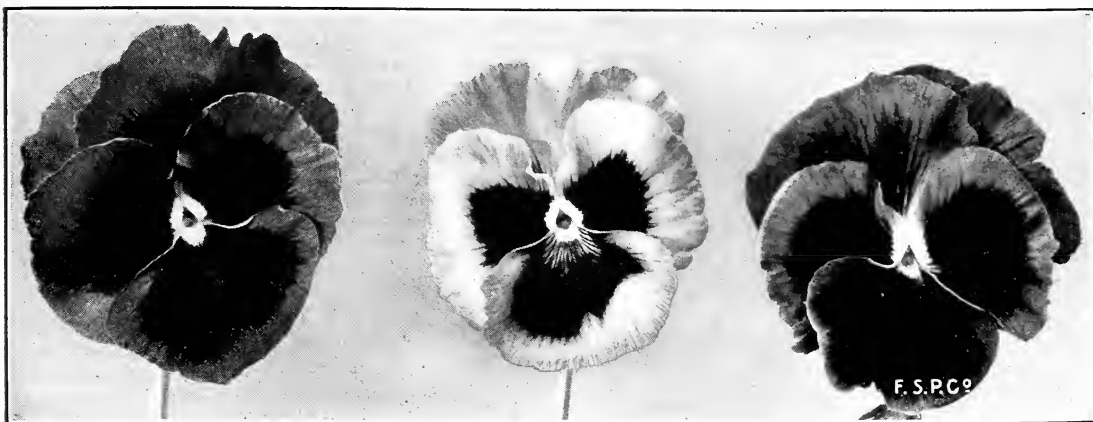

PLATT'S SUPERLATIVE PANSY.

Pansy.

Heartsease.

The pansy stands in a class by itself. It is a flower that everyone admires, even if only a small place to raise them. The pansy produces best results during the cool days of spring, and in a sandy loam thoroughly prepared and supplied with well-rotted manure. To assist germination by retaining moisture, cover the seed bed with sheeting or single burlap, removing as soon as seedlings begin to appear. From this time on it is important never to let the soil become dry; to do so is fatal; keep moist but not soaking wet. For early spring flowers, sow seed in August and protect during the winter.

Pansies in Mixtures.

Platt's Superlative Mixed. This is a very rich mixture of giant long-stemmed pansies, early and free blooming, containing the choicest sorts grown by foremost specialists. It has a very wide variation of colors, including new velvet-like red and gold shades, also ruffled types. The plant is of strong, compact growth. To those wishing extra quality we can highly recommend it as one of the finest obtainable. Price per oz., \$8.00; per pkt., 25c.

Roggli or Swiss Giants. New variety of great size; an outstanding development in pansies. Very attractive, unusual colors, mostly blotched. Price per 1/8-oz., \$1.00; per pkt., 25c.

Masterpiece. A distinct type of extra large size, having undulated petals, making it appear double. Mixed colors. Price per oz., \$6.00; per pkt., 25c.

Giant Madame Perret. A fine large strain, producing mostly flowers of rose, ruby and wine shades on white ground. Price per oz., \$3.50; per pkt., 15c.

Parisian Giant. Trimardeau type. Many beautiful shades and colorings. Mostly white ground and five spotted. Price per oz., \$4.00; per pkt., 15c.

Orchid Flowered. A distinct and beautiful strain of Pansy, having delicate tints and soft shades of colors. Price per oz., \$4.00; per pkt., 25c.

Trimardeau Mixed, or Giant Pansies. Are very much improved in every respect over the older sorts of the same name. Of strong, robust growth, well-formed flowers, moderately large size and great variety of color. Price per 1/4-lb., \$7.50; per oz., \$2.00; per pkt., 10c.

Fine Mixed. Consisting of a good variety of colors, though not large flowered as above, inclined to be more free flowering. Price per 1/4-lb., \$4.00; per oz., \$1.25; per pkt., 10c.

Separate Colors.

Roggli Alpenglow (Swiss Giant). Cardinal shades. Very beautiful, new and striking addition to pansy colors. Price per 1/8-oz., \$1.00; per pkt., 25c.

Roggli Golden Yellow. A new addition to the Swiss Giant group. Price per 1/8-oz., \$1.00; per pkt., 25c.

Roggli Lake of Thun. (Swiss Giant). Solid deep blue, magnificent; the finest of all blue pansies. Price per 1/8-oz., \$1.00; per pkt., 25c.

Lord Beaconsfield. Giant Trimardeau. Deep purple-violet, shading to white on the upper petals; very effective. Price per oz., \$3.00; per pkt., 10c.

King of the Blacks. Giant Trimardeau. Almost coal black. Price per oz., \$3.00; per pkt., 10c.

Emperor. Giant Trimardeau. Ultra-marine blue, with purple violet eyes. Price per oz., \$3.00; per pkt., 10c.

Peacock Blue. Giant Trimardeau. Rich velvety blue, white edge. Price per oz., \$3.00; per pkt., 10c.

Light Blue. Giant Trimardeau. Beautiful sky blue. Price per oz., \$3.00; per pkt., 10c.

Golden Queen. Giant Trimardeau. Large, deep golden with dark eye. Per oz., \$3.00; per pkt., 10c.

Snow Flake. Giant Trimardeau. Pure satiny-white; very fine. Price per oz., \$3.00; per pkt., 10c.

Passiflora.

Passion Flower.

Indispensable climbing plants for the garden or greenhouse, bearing a profusion of attractive flowers.

Coerula. Blue. Price per oz., \$1.75; per pkt., 15c.

Pentstemon.

Sensation Improved French Hybrids. Price per 1/4-oz., \$1.50; per pkt., 15c.

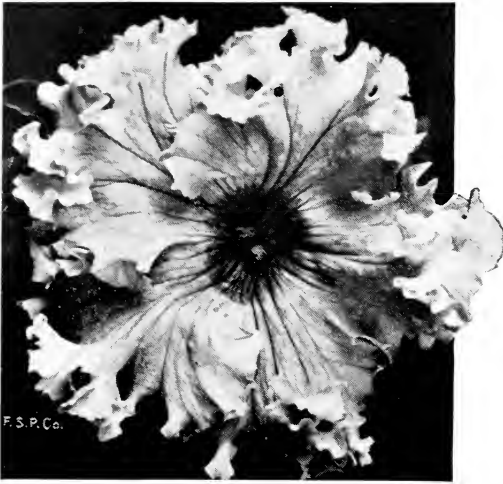

PLATT'S SUPERB LARGE-FLOWERING.

Petunia.

The brilliancy and variety of its colors, combined with the duration of its blooming period render it invaluable. The plants are of easy culture and thrive well in any good garden soil.

Double Mixed. Large-flowering, fringed; one of the finest strains obtainable. Double Petunias do not come true from seed. This strain will produce 30 to 35 per cent double flowering plants, which is a high per cent. The weaker plants should be carefully saved, as they usually produce the finest double flowers. Per $\frac{1}{8}$ -oz., \$9.00; pkt., 50c.

Platt's Superb Large-flowering. Single ruffled and fringed giants saved from finest flowers; of very large size, deep-throated and of varied brilliant colors. Price per $\frac{1}{8}$ -oz., \$4.00; per pkt., 25c.

California Giants. The flowers are very large and colors embrace many shades from crimson to white and violet, lavender, etc. Price per $\frac{1}{8}$ -oz., \$4.00; per pkt., 25c.

Pink Triumph. Best, large fringed, bright pink. Price per $\frac{1}{8}$ -oz. \$3.50; per pkt., 25c.

Theodosia. Largest fringed, soft rose pink. Sulphur yellow in throat. Price per $\frac{1}{8}$ -oz., \$5.00; per pkt., 25c.

Romany Lass. Large fringed flower. Deep crimson, darker throat. Price per $\frac{1}{2}$ -oz., \$5.00; per pkt., 25c.

Steel Blue. Large flowered, fringed. Very effective. Price per $\frac{1}{8}$ -oz., \$8.00; per pkt., 25c.

Elk's Pride. Richest royal purple, plain edged, medium size. A wonderful porch box plant. Per $\frac{1}{8}$ -oz., \$3.00; per pkt., 25c.

Balcony Blue. Rich velvety blue. Price per $\frac{1}{8}$ -oz., \$1.00; per pkt., 15c.

Balcony Rose. Rose pink. Price per $\frac{1}{8}$ -oz., 75c.; per pkt., 15c.

Balcony White. Splendid large-flowered type for window boxes or baskets. Price per $\frac{1}{8}$ -oz., 75c.; per pkt., 15c.

Rosy Morn. Compact plants. Bright rosy pink, white throat, beautiful free bloomer; the most popular small flowered bedding petunia. Price per oz., \$3.00; per pkt., 10c.

Silver Blue. Light blue, medium-sized flowers; same compact plant type as Rosy Morn and very beautiful in effect planted with it. Price per oz., \$4.00; per pkt., 10c.

Snowball. Pure white flowers, on compact pl. nts. Very fine. Price per oz., \$3.00; per pkt., 10c.

Howard's Star. A small free-flowering strain, color crimson-maroon, with a clearly defined five-pointed star of blush white. Price per $\frac{1}{4}$ -oz., \$1.00; per pkt., 15c.

Striped and Blotched. A good strain of the small flowering type; fine for massing. Price per oz., \$1.50; per pkt., 10c.

Hybrida Compacta Mixed. Very rich, free blooming mixture of the smaller-flowered type, for bedding. Price per oz., \$1.50; per pkt., 10c.

Phlox.

This splendid genus of plants is unrivaled for richness of color, profusion of blossoms, length of duration in bloom, and whether in clumps or masses, look equally beautiful.

Grandiflora.

Those of the Grandiflora type are the largest flowered and grow about 15 inches high.

Alba. Pure white, extra large. Price per oz., \$1.50; per pkt., 10c.

Brilliant Rose. Price per oz., \$1.50; per pkt., 10c.

Chamois Rose. Shell pink. Price per oz., \$1.50; per pkt., 10c.

Vivid Crimson. Price per oz., \$1.50; per pkt., 10c.

Violacea Alba-Oculata. Violet with white eye. Price per oz., \$1.50; per pkt., 10c.

Large Yellow. A very fine color. Price per oz., \$1.50; per pkt., 10c.

Grandiflora Splendid Mixed. Includes all of the above and many other shades and colors. Price per oz., \$1.00; per pkt., 10c.

Star of Quedlinburgh. Star-shaped Phlox of dwarf habit, with very pretty flowers, mixed colors. Price per oz., \$1.50; per pkt., 10c.

Dwarf Phlox.

Phlox Drummondii Nana Compacta.

These are the best for ribbon bedding or borders. The plants grow very symmetrically in neat little bushes about eight inches high; covered with flowers during the whole summer and fall.

Snowball. Flowers pure white; the plants resemble large snowballs when in full bloom. Price per oz., \$3.00; per pkt., 10c.

Fireball. Glowing brilliant scarlet. Price per oz., \$3.00; per pkt., 10c.

Chamois Rose. Shell pink. Price per oz., \$3.00; per pkt., 10c.

Dwarf Phlox, Mixed. Per oz., \$2.00, per pkt., 10c.

Hardy Perennial Phlox. New hybrids containing new and brilliant colors. One of the finest for hardy border; height 3 to 3½ feet. Hardy phlox seed should be sown soon after harvest as possible and kept moist during winter. Seed germinates in spring and blossoms first year. Price per oz., \$2.00; per pkt., 10c.

Poppies.

Well-known hardy annuals and perennials, flowering in profusion throughout the summer. The brilliant colorings of the poppy family, both single and double, varying as they do from the most intense scarlet down through the whole range of coloring to the delicate pink, yellow and white, make them indispensable in the flower garden.

American Legion. (New Shirley). Brilliant orange scarlet, enormous size, borne on long, stout stems. Highly commended, R. H. S. Price per oz., 75c.; per pkt., 10c.

Poppies—Continued.

Shirley Wild Rose Pink. Price per oz., 60c.; per pkt., 10c.

Shirley. Finest Mixed. A beautiful type and a great variety of colors, from pure white and delicate pink to deep crimson and beautifully striped. A most charming variety. Two feet. Price per oz., 40c.; per pkt., 10c.

Double Shirley (Eldorado). New Strain, beautiful shades mixed. Per oz., 75c.; pkt., 10c.

Danebrog or Danish Cross. Large flowers of brilliant scarlet with a silvery-white spot on each petal, forming a white cross. Per oz., 35c.; pkt., 10c.

Tulip Flowered. Brilliant scarlet flowers borne well above the foliage. The petals form a tulip-shaped cup and after a time black spots appear at the base of each petal. Hardy annual. One foot. Price per oz., 75c.; per pkt., 10c.

The Bride. Pure white fringed. Price per oz., 25c.; per pkt., 10c.

Mikado. Double white striped crimson. Three feet. Price per oz., 30c.; per pkt., 10c.

Double Carnation Flowered. Finest Mixed. Three feet. Price per oz., 25c.; per pkt., 10c.

Paemony Flowered Shrimp Pink. Beautiful shade, fine in border or as cut flowers. Height three feet. Price per oz., 40c.; per pkt., 10c.

Paemony Flowered. Double flowers of the largest size, and paeony shaped. Finest mixed. Three feet. Price per oz., 25c.; per pkt., 5c.

HARDY PERENNIAL VARIETIES.

Oriental Crimson. Beauty of Livermere. Deep crimson with black blotch, fine large flowers. Price per oz., \$3.50; pkt., 10c.

Oriental Mrs. Perry. Immense flowers of beautiful soft salmon-pink shades. Price per 1/8-oz., \$1.00; per pkt., 25c.

Oriental The Feltham. A new departure in Oriental Poppies. A strain with nearly all the various shades of the type, but with no black blotches at the base of petals. Pkts. only 25c each.

Oriental Hybrids. Mixed. A fine new mixture ranging from delicate salmon to deep crimson. Price per oz., \$3.00; per pkt., 10c.

Nudicaule Coonara Pinks. A new outstanding strain with large flowers of lovely pink shades. Price per 1/8-oz., \$1.00; per pkt., 25c.

Nudicaule Sunbeam Mixed. New Strain. (Ice-land Poppy). If sown in March will flower the same year and thereafter throughout the entire season. The delicate and bright colors make them especially desirable as a border plant. Hardy perennial. One foot. Price per oz., \$3.50; per pkt., 10c.

Physalis Franchetii.

Chinese Lantern Plant or Winter Cherry.

Fruit is deep red in color, edible and enclosed in large, balloon-shaped husks of brilliant orange red. Popular for winter bouquets. Hardy annual. Price per oz., \$2.00; per pkt., 10c.

Portulaca.

(Sunplant).

These brilliant and popular hardy annuals are of the easiest culture, luxuriant in an exposed sunny situation, and producing throughout the summer a carpet of various colored flowers in the greatest profusion. Sow broadcast in May when ground is thoroughly warm.

Alba. Single. Clear white. Per oz., 75c.; pkt., 10c.

Rose. Coppery rose shades. single. Price per oz., 75c.; per pkt., 10c.

Splendens. Single, crimson. Price per oz., \$1.00; per pkt., 10c.



Splendid Mixed Single. Per oz., 60c.; pkt., 10c.

Large Flowering, Double Mixed. Large per cent flowers perfectly double, making a gorgeous display, remaining open all day. Price per oz., \$1.50; per pkt., 10c.

Primula.

Primula Chinensis.

A beautiful flowering plant for winter or spring decorations in the home or conservatory; 3/2-oz., contains about 1,000 seeds. The following are new giant flowering, a wonderful advance on the old type.

Giant Pink. A most striking shade of delicate carmine pink. The finest of all giant fringed primulas; petals extremely large and of great substance. Price per 3/2-oz., \$3.50; per pkt., 35c.

Queen Alexandra. The largest, fringed, white in existence; a grand advance on the old type. Price per 3/2-oz., \$5.00; per pkt., 35c.

Excelsior Giant Mixed. A magnificent strain of the giant fringed primula, includes the new and finest procurable. Per 3/2-oz., \$5.00; per pkt., 35c.

PRIMULA MALACOIDES.

Pink Beauty. A graceful type of primula which has become very popular for conservatory or house decoration in the brief time since its introduction. Numerous flower spikes in bloom over a long season are borne well above the mat foliage. Pink Beauty is one of the most beautiful in this class; rose pink with rich cream colored eye. Award of Merit R. H. S. Per 3/2-oz., \$3.00; pkt., 25c.

Primula Obconica.

The greatly improved form of this splendid plant makes it invaluable for pot culture. The many tall, stout stems bear large clusters of flowers well above the neat, ornamental foliage. Plants from seed sown early in the year commence flowering in Autumn and continue throughout the Winter. A temperature around 60 degrees seems to suit them best. In growing seedlings avoid peat or leaf-mold.

Obconica Gigantea. Chennie's Giant Hybrids. A new very fine, large flowered strain. Price per 3/2-oz., \$3.00; per pkt., 25c.

Polyanthus.

Primula Elatior.

Showy, early spring, free-flowering plants, fine for either pot or outdoor culture; hardy perennials. Give slight winter protection. Nine inches.

Polyanthus, English. An extra choice strain bedding hybrids. Price 1/8-oz., \$1.50; per pkt., 25c.



SALPIGLOSSIS.

Hardy Primroses.

These are among the best of the early spring blooming plants. With a slight protection they will stand the winter, but do better if protected by a cold frame.

Primula Japonica (Japanese Primrose). Mixed colors. Bright and showy flowers, borne in whorls on stems six to nine inches long. Price per oz., \$4.00; per pkt., 15c.

Primula Auricula. Large flowering choice strain, cream white to golden yellow and palest mauve to the deepest purple. Sweet scented. Price per 1/8-oz., 60c.; per pkt., 25c.

Pyrethrum.

Handsome herbaceous plants of easy culture. *P. Aureum* is the well-known Golden Feather, so much used for carpet bedding, edging, etc. From the flowers of *P. Roseum* is obtained the Persian insect powder. *P. Hybridum* and varieties are among the handsomest of hardy flowering herbaceous plants.

Aureum (Golden Feather). Dwarf compact form. Bright yellow foliage. Per 1/8-oz., 35c.; pkt., 10c.

Hybridum Grandiflorum. Large-flowering, single mixed. Hardy perennial, ranging in color from light pink to deep red, with bright yellow centers. Price per oz., \$4.50; per pkt., 10c.

Hybridum. Double mixed. Saved from a very choice collection. Price per 1/8-oz., \$2.00; pkt., 25c.

Rhodanthe.

Everlasting or Straw Flower.

Garden annual, one foot high, flowering early and continuously. Flowers are mostly white and rose shades on long slender stems.

Manglesii. Single, bright rose. Price per oz., \$1.00; per pkt., 10c.

Mixed. White and rose shades. Price per oz., \$1.00; per pkt., 10c.

Ricinus.

Castor Oil Bean.

Large, luxuriant, rapid-growing foliage, annual, with palm-like leaves; much used for sub-tropical effects on the lawn, or for centers of beds of foliage plants.

Borboniensis. Grows very large and rank; foliage green; 15 feet. Price per oz., 25c.; per pkt., 10c.

Red Spire. New, 6 feet. Attractive bronzy green foliage with rosy crimson seed spikes. Price per oz., 25c.; per pkt., 10c.

Gibsonii Mirabilis. Compact dwarf plants, 4 feet, very fine, red foliage and stems. Price per oz., 25c.; per pkt., 10c.

Zanzibarensis. Mixed. The different varieties included in our mixture have light and dark green leaves and some of coppery bronze, changing to dark green, with reddish ribs; six to ten feet. Price per oz., 25c.; per pkt., 10c.

Rudbeckia.

Cone Flower.

These robust-growing plants are fine free-flowering annuals. Of very easy culture.

Bicolor Superba. An annual variety; bright yellow with black-purple center. Price per oz., \$1.50; per pkt., 10c.

Neumani. Perennial; grows two feet; large golden-yellow flowers, with velvety maroon center cone. Price per oz., \$2.00; per pkt., 10c.

Salpiglossis.

Annual, about 18 inches high, bearing throughout the season large flowers of many beautiful colors, all exquisitely veined and laced.

| | 1/4-oz. | Pkt. |
|---|---------|------|
| Grandiflora Purple with Gold | 50c. | 10c. |
| Superbissima Brown with Gold | 50c. | 10c. |
| Superbissima Brilliant Crimson | 50c. | 10c. |
| Superbissima Large Flowering Mixed | 40c. | 10c. |

Salvia.

Flowering Sage.

Splendid ornamental plants for outdoor decorations, their beautiful spikes of brilliant scarlet flowers being produced in great profusion, from July until October. Half-hardy annual.

America (Globe of Fire). Very dwarf and uniform, the bushy plants are only 15 inches tall, with spikes in profusion rising ten inches above the plant; exceptionally valuable for beds, borders or edging. Price per oz., \$3.00; per pkt., 15c.

Salvia Harbinger. The earliest and finest dwarf type yet introduced. Per 1/8-oz., \$1.50; per pkt., 25c.

Splendens. Scarlet, free bloomer, three feet tall, old favorite variety. Price per oz., \$2.00; pkt., 10c.

Splendens "Bonfire" (Nana Compacta Erecta). Growing in a compact bush about two feet high.

Its erect spikes of flowers of brilliant scarlet stand clear above the dark green foliage and completely cover the plant. Price per oz., \$2.00; per pkt., 10c.

Zurich. Dwarf, early. Very free bloomer. Price per oz., \$3.00; per pkt., 15c.

Patens. Deep blue, tender perennial, not suitable for bedding. Price per 1/8-oz., \$1.25; per pkt., 25c.

Farinacea. Light blue, long spikes on compact bush, 2 to 3 feet tall. Perennial, but usually grown as an annual; fine for cutting or border; seed sown in open ground in May, blooming from July till frost. Price per oz., \$3.00; per pkt., 10c.

Scabiosa.

Mourning Bride.

Beautiful annuals with large double flowers on long stems; fine for cutting; various colors. Height 2 1/2 feet. They bloom from July until frost.

Shasta. New, large, pure white. Price per oz., \$1.00; per pkt., 10c.

Azure Fairy. Lavender blue. Price per oz., 75c.; per pkt., 10c.

Peach Blossom. New, very large. Price per oz., \$1.00; per pkt., 10c.

Large Flowering, Mixed. Price per oz., 50c.; per pkt., 10c.

Caucasica House's Hybrids. A new, improved strain with larger flowers and longer stems, colors range from light lavender to dark blue. The caucasica is a perennial; valuable in border and as a cut flower. Blooms June to September. Height 24 inches. Price per 1/8-oz., 85c.; per pkt., 25c.

Columbaria Anthemifolia. Pink. This is a South African distinct form. A valuable addition to the perennial list. Flowers borne on long, strong but graceful stems. Valuable as a florists' cut flower. Height 18 to 24 inches. Price per 1/4-oz., \$1.25; per pkt., 25c.

Schizanthus.

The Butterfly Flower.

Free-flowering plants of easiest culture, bearing dainty orchid-shaped and beautifully marked flowers. Annual.

Grandiflorus Maximus. New splendid large flowering greenhouse strain, brilliant coloring, handsomely marked on white, buff or purple ground. Price per 1/4-oz., \$2.50; per pkt., 25c.

Wisetonensis. A choice mixture of brilliant shades, excellent for potting or outdoor. Price per 1/4-oz., \$2.50; per pkt., 25c.

Silene.

Catchfly.

Annual, compact bushes, 6 inches high, densely covered with showy flowers of white, pink or red.

Armeria Mixed. Price per oz., 25c.; per pkt., 10c.

Smilax.

Myrsiphyllum.

Of great value for inside decoration. Greenhouse climber clothed from base to summit with small glossy green leaves.

Smilax. Price per oz., 75c.; per pkt., 10c.

Stevia.

Extensively used by florists. Beautifully effective with other cut flowers. The long but strong stems are branching and bear a multitude of fine white star-shaped flowers.

Serrata. Pure white and most desirable. Price per oz., \$2.50; per pkt., 10c.

Solanum.

An ornamental and interesting genus of fruit-bearing plants; singularly bright in fruit and foliage.

Capsicastrum (Jerusalem Cherry). Covered with scarlet fruit during the winter. 12 inches. Price per oz., \$1.50; per pkt., 10c.

Stocks.

Gilliflower. (Levkojen)

The free-blooming, fragrant and charming colors of the stock have brought it into great popularity both for summer and winter flowering. For beds and borders they are very effective, the blooms exceedingly useful for cutting. Our seed is produced by a specialist who has received several "Awards of Merit" from the Royal Horticultural Society. The high percentage of doubles is remarkable. Hardy annuals.

Double Early Giant Imperial Stocks.

An especially meritorious, early-flowering class. Grows 2 to 2 1/2 feet; branches freely, having



A SPIKE OF LARGE-FLOWERING STOCK.

numerous deliciously fragrant, large spikes, with a high percentage of doubles. Sow seed in February or March for blooms outdoors from mid-summer until frost. Sow during July to September for greenhouse, Winter pot plants or cutting.

| | 1/8-oz. | Pkt. |
|----------------------------------|---------|------|
| Pure White | 85c. | 10c. |
| Flesh Pink | 85c. | 10c. |
| Lavender | 85c. | 10c. |
| Blood Red | 85c. | 10c. |
| Purple (Elk's Pride) | \$1.25 | 10c. |
| Canary Yellow | 85c. | 10c. |
| Early Giant Imperial Mixed | 85c. | 10c. |

Giant Perfection Stocks.

(Double Perpetual Branching)

Splendid early and free-blooming group; sown in February or March they begin flowering in July, continuing until frost. Especially valuable for florists. They throw out numerous side branches bearing a high percentage of double, fragrant flowers. Excellent for cutting. Those marked (*) have received award of merit from R. H. S.

| | 1/8-oz. | Pkt. |
|----------------------------------|---------|------|
| Snow Drift. New early pure | 85c. | 10c. |
| Rose Pink* | 75c. | 10c. |
| Dark Red | 75c. | 10c. |
| Violet (Sapphire) | 75c. | 10c. |
| Silver Lilac* | 75c. | 10c. |
| Canary Yellow* | 75c. | 10c. |
| Giant Perfection Mixed | 75c. | 10c. |

Stokesia.

Cornflower Aster.

This plant grows about 24 inches high, bearing from 20 to 30 handsome lavender-blue cornflower-like blossoms; in bloom from July till frost. One of the choicest subjects for the hardy border, and indispensable for cutting. Price per 1/4-oz., \$1.50; per pkt., 10c.

The Choicest Spencer Sweet Peas. Waved Orchid-Flowered Varieties.

New names of Spencer Sweet peas are appearing so rapidly that to know them and what to select requires considerable time in experimental trials. Many of the sorts brought out only a few years ago have been dropped, while others are still unsurpassed. The newest are not always the best, and so this sifting process goes on each year. In the list below will be found a wide range of varieties, each having merits that make it worthy of a place in a list of the best Spencers. Our stock is grown with great care and has proved itself as fine quality as can be had.

Hints for successful growing of Sweet Peas.

In Connecticut Sweet Peas must be sown early, usually March 15 to April 1, as they grow best during the cool, moist days of early Spring. Prepare a trench 18 to 24 inches deep, for good root development, in rich sandy loam, adding about five pounds each bone meal and pulverized sheep manure for a 25 foot row; lime if soil is acid. Fill and firm well to a level. Sow only one-half inch deep using 1 oz. seed to 25 foot row. Do not sow deep or in a depression as formerly recommended. It is a good plan to prepare trench in the Fall. Fall sowing, about November 10, gives better and earlier plants where soil permits (a sandy loam well drained). If seeds should rot and need replanting, it is an easy matter to resow in Spring. Plants grow stronger if not less than 6 inches apart. Bamboo stakes make good supports. Commence to tie early.

Ascot. A beautiful shade of lovely soft pink. Large and well waved.

Austin Frederick Improved. A giant, bright lavender, of good form and stems.

Avalanche. The outstanding, pure glistening white; well waved and good stout stems.

Colorado. Bright Orange. The flowers are of great size and beautifully waved.

Constance Hinton. Mammoth white, of fine Spencer form. Young flowers generally show trace of pink, but change to pure white. Black seeded.

Crimson King. Rich deep crimson surpassing all other crimson sweet peas.

Del Monte. A beautiful, rich, salmon cerise-pink. Does not burn.

Huntsman. Bright glowing scarlet of finest form, replacing Hawlmark.

Magnet. A deep cream pink. Immense size and beautiful form on strong stems.

Mammoth. A fine large, blazing orange-scarlet. Awarded certificate of merit.



SPENCER HUNTSMAN.

Mary Pickford. Dainty cream pink, suffused salmon.

Olympia. The best rich purple, a strong grower and taking place of Royal Purple.

Pinkie. Large deep rose-pink; better than Hercules or Hebe.

Reflection. New, rich mid-blue. Blooms of large size and elegant form.

The Sultan. Large rich velvety maroon, well shaped.

What Joy. Flowers rich cream, beautifully waved on long stems.

Special Mixed Spencer. Silver Gilt Medal Mixture. Extra choice. A carefully proportioned mixture of named varieties, including all the best standard varieties, also newest worth while novelties of beautiful shades, making it a mixture that will surely please the most exacting. It is the finest obtainable, and incomparably better than seed grown as a mixture which can be sold for less than half our price. Price per oz., 25c.; per ¼-lb., 60c.; per lb., \$2.25.

Prices on any of above named varieties:

Per pkt., 10c.; per oz., 30c.; per ¼-lb., 85c.; per lb., \$3.00.

Sweet Peas—Continued.

EARLY or WINTER FLOWERING SPENCERS.

This class is adapted to forcing under glass or outdoor growing. It embraces some of the finest varieties in cultivation. Coming into bloom five weeks earlier than regular Spencers.

Early Flowering Spencers are valuable where the hot weather season comes early, for by early sowing they will come into bloom during more favorable weather.

| | Oz. | Pkt. |
|---|-----|------|
| All White. Largest waved. Pure white. \$ | .60 | 10c. |
| Blue Bonnet. Deep blue | .85 | 10c. |
| Fair Maid. Bluish-pink, suffused salmon | .60 | 10c. |
| Glitters. Bright orange scarlet | .60 | 10c. |
| Grenadier. Rich poppy scarlet | .60 | 10c. |
| Majestic Rose. Rose pink, suffused orange | .75 | 10c. |
| Sweet Lavender. New pure lavender.. | .60 | 10c. |
| Valencia. New sunproof orange..... | .75 | 10c. |
| Zvolanek's Rose. Deep rose pink | .60 | 10c. |
| Early Choice Mixed. Blended from named best varieties. Per ¼-lb., \$1.25 | .40 | 10c. |

Sweet William.

Dianthus Barbatu.

Attractive, free-flowering hardy perennials, producing a splendid effect in beds and borders with their rich and varied flowers.

| | Oz. | Pkt. |
|--|-------|------|
| Single White | \$.75 | 10c. |
| Single Pink Beauty (Newport Pink) .. | 1.50 | 10c. |
| Scarlet Beauty. Rich deep scarlet.... | 2.00 | 10c. |
| Single Nigrescens. Dark maroon..... | 1.00 | 10c. |
| Single Holborn Glory. A large-flowered strain of Auricula-eyed, beautiful colors all showing the white center | 1.50 | 10c. |
| Single Mixed Giant | .50 | 10c. |
| Double Mixed | 1.00 | 10c. |
| Annual. New sort, grows twelve inches tall. Seed sown early will flower in summer and continue for some time | 1.50 | 10c. |
| Sweet Wivelsfield. New hardy annual in great variety of color for borders, cut flowers and rock gardens; obtained from a crossing of <i>Dianthus Allwoodii</i> and <i>Dianthus Barbatu</i> . Seed started late February will bloom from June to November; sown in spring, blooms in the late summer. It can be sown from July to September to flower early in spring. Price per ¼-oz., \$1.00; per pkt., 15c. | | |

Thunbergia.

Black-Eyed Susan.

Ornamental, free-blooming climbers of rapid growth, handsome foliage, good for greenhouse culture, or in warm situations out-doors. Half-hardy annuals. Fine mixed. Price per oz., \$1.00; per pkt., 10c.

Valerian.

Garden Heliotrope.

An old-fashioned garden perennial bearing fragrant flowers of red or white. Price per oz., 75c.; per pkt., 10c.

Verbena.

A low-growing annual, profuse in its blooms, ranging from brilliant and startling colors to soft and delicate tints. The following is a magnificent new strain of the *Hybrida Grandiflora* Verbena with immense trusses and free flowering.

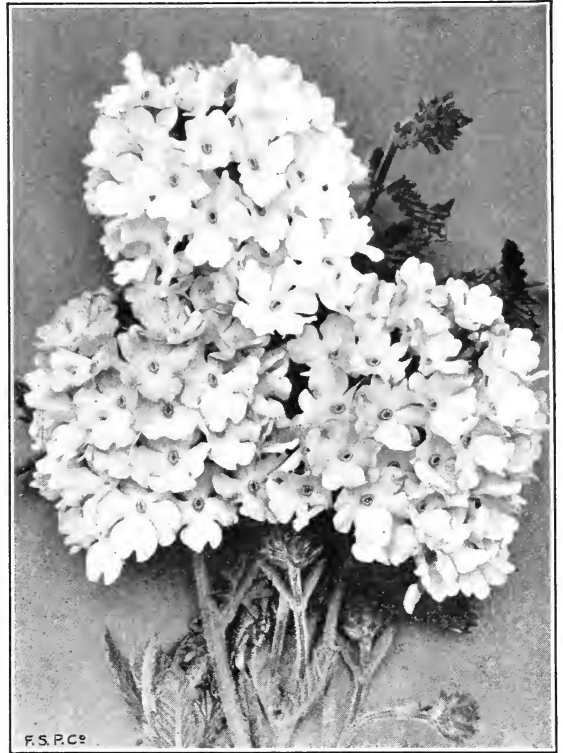

VERBENA.

| | Oz. | Pkt. |
|---|--------|------|
| Mammoth White | \$3.00 | 10c. |
| Mammoth Rosea Stellata. Rose pink, white eye | 3.00 | 10c. |
| Mammoth Lucifer. Scarlet | 3.00 | 10c. |
| Mammoth Violaacea Stellata. Deep violet, white eye | 3.00 | 10c. |
| Mammoth Choice Mixed. Improved type | 2.50 | 10c. |

Vinca.

Periwinkle or Old Maid.

Dark green foliage, handsome rose and white single flowers; very effective for beds and borders. Blooms continuously all summer from seed sown early in March. Half-hardy perennial.

| | Oz. | Pkt. |
|--|------|------|
| Rosea Alba. White with rose center. | 1.50 | 10c. |
| Alba Pure. Pure white | 1.50 | 10c. |
| Mixed | 1.50 | 10c. |

Wall Flower.

A well-known plant of the Gillyflower family, producing its rich orange or chocolate flowers in the spring, if protected in the house during the winter. Half-hardy perennial and annual.

| | Oz. | Pkt. |
|---|--------|------|
| Double. Finest mixed perennial | \$2.00 | 10c. |
| Paris Market. Early, single annual ... | .75 | 10c. |
| Early Wonder. New double annual .. | 3.00 | 15c. |

Mixed Flower Seed.

The seeds we offer as mixed comprise a wide variety at a much lower price than could be sold in separate packets. Nearly every garden has a spot which could be used to good advantage and satisfaction, yielding a continuous show and supply for cutting.

| | Oz. | Pkt. |
|--------------------------|-------|------|
| Dwarf Mixed | \$.25 | 5c. |
| Tall Mixed | .25 | 5c. |



GIANT DAHLIA FLOWERED ZINNIAS

GOLD MEDAL DAHLIA FLOWERED. (Originator's Stock).

Zinnias are now the most popular Annual in the world of gardening. They are suitable for florists' use, for the house gardens and household decoration. The easy culture and long blooming season make them profitable and interesting. Their varied forms and exquisite colors have brought them into prominence in flower shows both in United States and other countries the past ten years. The Dahlia Flowered type, introduced by the late John Bodger in 1919, which received a Gold Medal and Award of Merit from the Royal Horticultural Society in London in 1924, set a new fashion in Zinnias.

Every year our grower is adding new colors, increasing the size and perfecting the form. The rapidly increasing demand for improved types will necessitate planting over three hundred acres this year and ten acres exclusively to the development of new varieties.

| | Oz. | Pkt. |
|---|--------|------|
| Crimson Monarch. By far the largest and best of the red shades | \$2.25 | 10c. |
| Dream. Deep lavender turning to purple .. | 2.25 | 10c. |
| Exquisite. Light rose, center deeper rose.. | 2.25 | 10c. |
| Golden State. A very rich orange yellow.. | 2.25 | 10c. |
| Oriole. An immense orange and gold bicolor | 2.25 | 10c. |
| Polar Bear. A very large, pure white | 2.25 | 10c. |
| Dahlia Flowered Gold Medal Mixture. A well-blended mixture of all the above and many others ¼-oz., 40c. | 1.50 | 10c. |

CALIFORNIA GIANTS.

This mutation from the Dahlia Flowered type was introduced in 1926. It has since been further developed for florists' and general use. The great advantage of this

type is that the very large flowers are imbricated and flat, getting away from the older conical type of Giants and eliminating the stiffness that has been so objectionable in Zinnias in the past. The flowers from the time they open are attractive making them a good cut flower from the early bud until they are in full bloom. They are twice the size of the ordinary Giants.

| | ¼-oz. | Pkt. |
|---|--------|------|
| Lemon Queen. Lemon-orange | \$1.75 | 10c. |
| Orange King. Cadmium or burnt orange.. | 1.75 | 10c. |
| Purity. White | 1.75 | 10c. |
| Rose Queen. Striking bright rose | 1.75 | 10c. |
| Scarlet Gem. Glowing scarlet | 1.75 | 10c. |
| Finest Mixed. Above and other colors.... | 1.75 | 10c. |

PICOTEE DELIGHT.

Season's Novelty 1930

Delight can be classed as a Pumila type, very floriferous and of compact growth. The petals of the flower are ruffled and curled, giving a light and dainty effect. In addition, each petal is beautifully picoteed, making it a striking flower of medium size. The objectionable stiffness has been removed. The new type will be of incalculable value to the florist.

The assortment of colors is most suitable. It includes salmon shades, cream, buff, biscuit, golden yellow and lavender. **Delight.** Price per ¼-oz., 90c.; per pkt., 15c.

MEDIUM AND SMALL FLOWERING TYPES.

Valuable for massing in the garden and continuous succession of cut flowers throughout the summer.

| | Oz. | Pkt. |
|---|--------|------|
| Curled and Crested Mixed | \$1.00 | 10c. |
| Elegans Cut and Come. Medium sized ... | .75 | 10c. |
| Elegans Liliput. Double Mixed | 1.00 | 10c. |



CALADIUM ESCULENTUM.

Caladium Esculentum.

Elephant's Ear.

One of the largest of ornamental foliage plants; grows in any garden soil, and when full size, stands four or five feet high, with immense leaves measuring four feet in length by two and one-half feet in breadth.

| | | | |
|-------------------------|---------------|-------|--------|
| | Circumference | Each. | Doz. |
| First Size Bulbs | 12 inch | 25c. | \$2.50 |
| Second Size Bulbs | 9-11 inch | 15c. | 1.50 |

Postage extra, 3 and 5 oz. each.

Madeira Vine.

The Madeira Vine is a beautiful climber, with thick glossy light green leaves, climbing twenty feet or more, and twining in any desired form. Price each, 10c.; per dozen, \$1.00. Postage extra; weight 4 oz. per dozen.

Double Tuberose.

The Tuberose, being a native of a tropical climate, requires the extreme heat of summer, and will not bloom till late, unless started in the forcing-house or hot-bed, in February or March. They may be transferred to open ground after the soil has become warm and settled summer weather prevails. The bulbs are extremely sensitive; a slight freezing destroys the crown or heart.

Excelsior Dwarf Pearl.

First Size. Each, 5c.; per doz., 50c.; per 100, \$3.75. Postage extra; 1 lb., per doz.

Cinnamon Vine.

Beautiful summer climber; glossy foliage and fragrant flowers; stem dies down in winter, but the root is hardy.

Large selected roots. Price each, 10c.; per doz., \$1.00. Postage extra; 4 oz. per doz.

Gladiolus.

The most brilliant and showy of all summer-flowering bulbs. Their immense spikes of gorgeous bloom comprise in color all shades from white to the deepest scarlet, purple and yellow, with blotchings and markings of charmingly contrasted shades. They will grow in any good garden soil, and bloom with the most ordinary care. The bulbs should be planted at intervals in April and May, to secure a succession of bloom. Take up in the fall and store in a dry cellar or other cool place, well protected from frost.

Note. The following are bulbs 1¼ to 1½ inches in diameter and not to be confused with the so-called mailing sizes offered at lower prices. Experienced growers consider this the best flowering size.

| | | |
|--|--------|--------|
| | Doz. | 100. |
| Alice Tiplady. Primulinus Orange saffron | \$.35 | \$2.50 |
| America. Flesh pink | .35 | 2.50 |
| Anna Eberius. Purple, deeper in throat | .55 | 4.00 |
| Carmen Sylva. Purest white, early | .55 | 4.00 |
| Crimson Glow. Early deep crimson | .40 | 3.00 |
| Dutchess of York. Indigo blue. Better than B. J. Hulot | .75 | 5.50 |
| E. J. Shaylor. Deep rose pink. Ruffled | .40 | 3.00 |
| Evelyn Kirtland. Light rose pink, scarlet blotched on lower petals | .55 | 4.00 |
| Flora. Early clear golden yellow | .55 | 4.00 |
| Halley. Delicate salmon pink | .35 | 2.50 |
| Herada. Pure mauve with deep markings | .40 | 3.00 |
| Jack London. Deep salmon pink. Ruffled | .55 | 4.00 |
| Lucette. White tinged soft pink | .55 | 4.00 |
| Mrs. Dr. Norton. Delicate pink sulphur throat | .55 | 4.00 |
| Mrs. Francis King. Scarlet | .40 | 3.00 |
| Mrs. Frank Pendleton. Salmon pink, deep red blotch in throat | .40 | 3.00 |
| Mrs. Frederick C. Peters. Rich rosy lavender | .55 | 4.00 |
| Mrs. Leon Douglass. Exhibition salmon | .55 | 4.00 |
| Pride of Wanakah. American Beauty Rose | .55 | 4.00 |
| Schwaben. Best yellow | .55 | 4.00 |
| W. H. Phipps. LaFrance Pink, enormous flowers | .75 | 5.50 |
| Special Mixture. Contains many new and rare sorts | .35 | 2.50 |
| Primulus Hybrids. New distinct type, slender orchid-like .. | .35 | 2.50 |

Also other choice sorts not listed above.

Postage extra; weight 6 lbs. per 100.



GLADIOLUS.

VEGETABLE PLANTS AND ROOTS.

We grow large quantities of vegetable plants and roots, and can supply all the varieties listed below in their proper season. Prices are not postpaid.

Artichoke (Jerusalem). Price per lb., 10c.; 3 lbs., 25c.; per pk., \$1.00; per bu., \$3.50.

Asparagus Roots. Strong one-year-old roots recommended; they are better than 2 or 3-year-old roots. Mary Washington are rust-resistant and very much the best. Price, see page 7.

Cabbage Plants (Hot-bed or transplanted in flats). Ready after April 1st. Golden Acre, Copenhagen Market. Succession. Price per doz., 20c.; per 100, \$1.25. Field plants, June and July, per 100, 50c.; per 1,000, \$4.00.

Cauliflower Plants. (Hot-bed). Price per doz., 25c.; per 100, \$1.50.

Celery Plants. Ready July 1st. Golden Plume, Easy Blanching, and Giant Pascal. Price per 100, 75c.; per 1,000, \$5.50.

Chives. For flavoring. Price per clump, 15c.; per doz., \$1.50.

Egg Plants. Ready in May and June. Transplanted—40c. per doz.; \$3.00 per 100. In pots—85c. per doz.; \$6.00 per 100.

Horse Radish Sets. Bohemian or "Maliner Kren." Price per doz., 20c.; per 100, \$1.25; per 1,000, \$9.00.

Lettuce Plants. Ready in April and May. Price per doz., 20c.; per 100, \$1.25.

Pepper Plants. Ready in May and June. Price per doz., 20c.; per 100, \$1.25.

Rhubarb Roots. Victoria. Strong roots. Price each, 20c.; per doz., \$1.75. Small roots, each, 15c.; per doz., \$1.25; per 100, \$10.00.

Sweet Potato Plants. Yellow and Red. Price per bunch of twenty-five, 20c.; per 100, 75c.; per 1,000, \$6.00.

Tomato Plants. Grown from our own seed, select stocks. Transplanted. Ready in May and June. We can always supply through season well-grown plants of the leading varieties. Price per doz., 25c.; per 100, \$1.50.

Special quotations on application for large quantities.

Flowering Plants. We grow large numbers of the new and choice annual flowers, principally in two-inch pots, at prices from 75c. to \$1.00 per dozen. Grown only from our special strains of extra select seed. This method is very economical and satisfactory. Write for list if interested.

INSECTICIDES AND FUNGICIDES.

Poisons are not mailable

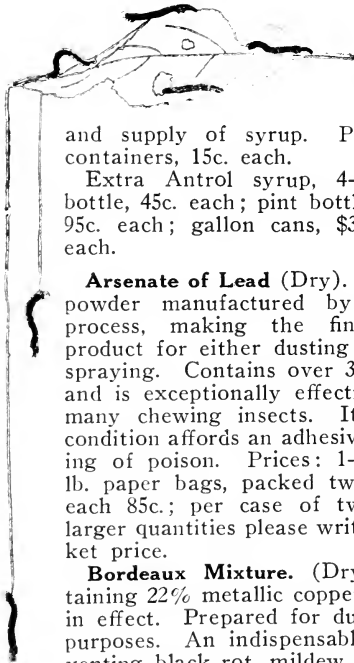

Antrrol. The new way to kill ants. Cottage Sets, consisting of 4 containers

and supply of syrup. Price, 95c. Extra containers, 15c. each.

Extra Antrrol syrup, 4-oz. bottle, 45c. each; pint bottles, 95c. each; gallon cans, \$3.75 each.

Arsenate of Lead (Dry). A powder manufactured by a process, making the finest product for either dusting or spraying. Contains over 30% arsenic oxide and is exceptionally effective in controlling many chewing insects. Its extremely fine condition affords an adhesive protective coating of poison. Prices: 1-lb. bags, 25c.; 4-lb. paper bags, packed twelve to the case, each 85c.; per case of twelve, \$7.68. For larger quantities please write for lowest market price.

Bordeaux Mixture. (Dry Powder). Containing 22% metallic copper. Same as liquid in effect. Prepared for dusting or spraying purposes. An indispensable Fungicide, preventing black rot, mildew, blight, rust, scab and many fungoid diseases on fruits and plants. Mixed with Arsenate of Lead is a valuable combination for chewing insects. Prices: 1-lb. bags, 35c.; 4-lb. paper bags, packed twelve to case, each \$1.10; per case of twelve, \$12.50. For larger quantities please write for lowest market price.

Bordeaux Lead. (Powder). This combination has great killing power, together with the best fungicide known for general use, making it a



complete spray for many uses where both chewing insects and blight are to be prevented. Prices: 1-lb. bags, 35c.; 4-lb. paper bags, packed twelve to the case, each, \$1.10; per case of twelve, \$12.50. For larger quantities please write for lowest market price.

Calcium Caseinate. The casein product which, added to the regular spray solution, increases its spreading and adhesive qualities, thereby its effectiveness. Use 1 lb. per 50 gals. Price: 2 lbs., 45c.; per 10 lbs., \$2.00; per 50 lbs., \$8.50; per 100 lbs., \$15.00.

Crow Repellent. "Crocus." One pint treats 2 bu. Corn. A small cost to insure Corn against the depredations of crows pulling the seed. Price: 1 pt., \$1.00.

Cut Worm Food. Snarol. (Bait Meal). It does not injure or affect the growing plants in any way, and if applied as directed on package there should be little trouble from this pest. Per 1½ lb., pkg. 45c.; 4 lbs., 95c.; 15 lbs., \$3.50; 50 lbs., \$9.50.

Cyanogas "A." For the destruction of Woodchucks, Rats, Groundmoles and other rodents. Per ½-lb., 45c.; 1 lb., 75c.; per 5 lbs., \$3.00.

Cyanogas "G." Greenhouse fumigant for the control of white fly, aphid, trips and soft scale. Per 5 lbs., \$3.00; 25 lbs., \$10.00.

Grape Dust is a preparation to kill the destructive mildew that strikes the grape vine and other plants or trees affected with mold, mildew, or rust mites, and for any use where a fumigator or anti-septic is required. Price, five-pound package, 75c.

Hellebore, Powdered White. For the destruction of slugs, worms, caterpillars, etc. Less poisonous than Paris Green, and safer to use when fruits or vegetables are nearly ripe. Can be used as a powder or dissolved, 1 oz. in 3 gallons water. Price per ½-lb., 25c.; per 1 lb., 40c.

Insecticides and Fungicides—Continued.

Lime-Sulphur Solution. (Concentrated). Recommended for San Jose Scale, Oyster Shell Scale, etc. Ready for use by adding 10 to 40 gallons water to each gallon. One-qt. can, 40c.; 1-gal. can, 85c.; 5-gal. can, \$2.50; 10-gal., \$4.75; 50-gal. bbls. \$10.50; 5-bbl. lots at special rates.

"Nico-Fume." "Nico-Fume" liquid is made from very high strength Nicotine solution and is free from the Ammonia and excessive Nitrates contained in tobacco stems. Therefore, many delicate plants which would be seriously damaged by smoke from tobacco stems may be strongly treated with "Nico-Fume" without the least injury—it neither deforming the buds nor discoloring the blooms nor leaving any odor upon them. "Nico-Fume" liquid contains never less than 40% nicotine. "Nico-Fume" liquid may be satisfactorily employed either for fumigating or for spraying. Price: 1-lb., \$2.00; 4 lbs., \$3.85; 8 lbs., \$10.85.

Nico-Fume Tobacco Powder. Nicotine not less than 12.5%. For Greenhouse fumigating. Especially prepared for burning. Price: 1-lb. tin, \$1.00; 5-lb. tin, \$3.50; 10-lb. tin, \$6.15.

Nicotine Solution ("Black Leaf 40"). Active ingredient nicotine 40% in a sulphate form. Especially adapted for all soft-bodied sucking insects or aphids in the open not being "free." Use 1 oz. in six to twelve gallons water, according to use. Per oz., 35c.; ½-lb. bottle, \$1.25; 2-lb. tin, \$3.75; 10-lb. tin, \$11.85.

Paris Green, Strictly Pure. A poisonous insecticide in powder form for insects which chew. As a liquid use 1 lb. to 50 to 100 gallons water. Per ¼-lb., 20c.; per ½-lb., 35c.; per lb., 65c.

Pomo-Green with Nicotine. The leaf-green, all-in-one dust or spray; ¼-lb. makes one gallon of spray or use dry in duster. Especially recommended for Rose Black Spot, Rust, Mildew, Aphids and chewing insects. Highest rating given in tests conducted by American Rose Society. Price per lb., 75c.; 5 lbs., \$3.00.

Pyrox. A combination spray for leaf-chewing insects and at the same time combining a fungicide in paste form. One pound makes from 5 to 10 gallons of spray. Price: 1 lb., 50c.; 5 lbs. \$1.75; 10 lbs., \$3.00; 25 lbs., \$6.00; 50 lbs., \$10.75; 100 lbs., \$15.50.

Red Arrow Insect Spray. A powerful, new non-poisonous insecticide. Harmless to plants, children, and pets but deadly to insects. Red Arrow has no sediment to clog the sprayer or color to stain even a white blossom. It kills insects by contact. Used normally at rate of one part to 800 parts water; that is, 1 oz. makes 6 gals. spray; ½-pt. makes 50 gals. Price: 1 oz., 35c.; 3½ oz., \$1.00; 8 oz. (½-pt.), \$1.75; 1 qt., \$6.00; 1 gal. \$20.00. Being non-poison can be sent by mail. Postage within 300 miles is 7c. on the oz. 3½ oz. or 8 oz. size; 1 qt., 9c. postage.

Scalecide. Complete dormant spray. The quality Miscible oil. Oldest and best-known dormant spray for trees, shrubs and vines. Makes them more beautiful, healthful and fruitful. Used by leading fruit growers. Pleasant to use, non-caustic, non-corrosive, non-poisonous. Kills scale, insects, eggs, larvae, and fungus-spores wintering on

the plant. Mixes instantly; dilute 1 to 15. Prices: Per qt., 70c.; per gal., \$1.60; 5 gals., \$6.00; 10 gals., \$10.00; 15-gal. steel drum, \$13.50 (refund for empty drum, \$2.00, f. o. b. factory, or \$1.75 New Haven); 50-gal. bbl., \$34.00. One gallon equals 3½ gallons Lime-Sulphur.

Sulfocide. A valuable summer fungicide. Used at rate of 1-200. Price per pt., 70c.; 1 qt., \$1.00; 1 gal., \$2.75.



Semesan. Seed, plant and soil diseases rob you of from 10 to 90% of the fruits of your land and labor—and NEEDLESSLY. You can change this loss into a gain by stopping disease before it gets a start through disinfecting your seeds, seed pieces and soil with DuBay Semesan. Semesan is the only organic mercury disinfectant which can be applied, either the liquid or convenient dust form. It prevents or controls a most diversified variety of diseases borne by seeds, seed pieces, bulbs, plants and grafts, as well as many of those which infect the soil. It generally hastens germination, produces sturdier plants and increases both the quantity and quality of crop yields. Shipped by express or freight; can not be sent by mail.

Prices: Semesan for general use, 2 oz., 50c.; 1 lb., \$2.75; 5 lbs., \$13.00; 25 lbs., \$56.25.

Semesan, Jr. (Prepared especially for Corn), 4 oz., 50c.; 1 lb., \$1.75; 5 lbs., \$8.00.

Semesan Bel. (Prepared specially for Potatoes and Bulbs), 1 lb., \$1.75; 5 lbs., \$8.00; 25 lbs., \$31.25; 100 lbs., \$120.00.

Send for crop booklets and information on special uses.

Soap—Red "A". Liquid insecticide soap. A neutral, potash, cocoanut oil product for use with contact insecticides. More convenient and several times as effective as fish oil and other cake soaps. Commonly used dilution: 1 to 400 (1 pt. to 50 gals.) Price per ½-pt., 35c.; 1 pt., 60c.; 1 qt., \$1.00; 1 gal., \$3.00.

Slug Shot. A non-poisonous and a very popular insecticide; it requires no further mixing or preparation, easily applied and not injurious to trees or dangerous to animals, the person applying it, or fruits and vegetables treated. Very effective in destroying potato bugs and beetles, green and black fly, slugs, worms, caterpillars, etc. Per 1 lb., 20c.; 5 lbs., 55c.; 10 lbs., \$1.10.

Sulphur. Superfine for dusting. Price per lb., 8c.; per 100 lbs., \$4.50.

Tree Tanglefoot is a sticky substance similar to that used on Tanglefoot fly-paper. It is a most simple and economical remedy for protecting trees against canker worms or any other climbing insects. Will remain sticky three months. Price: 1 lb., 60c.; 5 lbs., \$2.75; 10 lbs., \$5.25; 25 lbs., \$11.00.

Volck. A refined oil-emulsion for use on tender foliage for control of red spider, white fly, trips, scale, etc. Cleanses the foliage. One part Volck used with 33 to 100 parts water. Prices: ½-pt., 50c.; 1 pt., 75c.; 1 qt., \$1.00; 1 gal., \$3.00; 5 gals., \$12.00.

Insecticides and Fungicides—Continued.

Tobacco Dust. This is a high nicotine content fine powder and a specific for aphid, flea beetles, etc. It is also a good fertilizer and preventive for insects in the ground and about roots. Per 2-lb. pkg., 20c.; 100-lb. paper-lined bag, \$5.25.

Weed Killer, "Herbicide." This is a combination of chemicals in concentrated liquid form for use in clearing grass and weeds from roads, gutters, tennis courts, etc. "Herbicide" not only kills both tops and roots, but also seeds, and has a sterile effect on the ground, thus retarding the growth of future crops. It is applied by means of a sprinkling can or apparatus, diluted, one gallon "Herbicide" with 20 to 40 gallons of water. Each diluted gallon will cover about 25 square feet of ground. It is not injurious to metal, stone or wood-work, and does not stain the ground. It binds and lays dust. Price: 1 qt., 70c.; 1 gal., \$2.00; 5 gals., \$7.50; 10 gals., \$12.50; 30 gals., \$30.00.



Weed Killer. Atlacide (Calcium Chlorate). A non-poisonous weed killer in dust form. Simply shake powder from can on any undesirable vegetation, including poison ivy, Canada thistle, Johnson grass, etc., without danger of poisoning humans or animals. Especially recommended for obtaining weed-free driveways, paths, tennis courts and gutters. Price: 1-lb. size, 50c.; 3½-lbs. in Duster Package (sufficient to treat 350 sq. ft.), \$1.50.

Bulk size for refilling duster or making solution.

| | |
|-----------------------------------|---------|
| 15 lb. drum | \$ 3.50 |
| 50 lb. drum | 10.00 |
| 100 lb. drum (for 10,000 sq. ft.) | 19.00 |

FERTILIZERS.

Feed Your Plants and See Them Grow!

Platt's Concentrated Plant Food. This is a highly concentrated form of Plant Food for house plants, conservatories and small outdoor plantings. It may be applied dry or in solution and is sure to produce satisfactory results. Price, 5-oz. package, 25c.; 12-oz. size, 50c.; by mail, add 7c. for 300-mile limit.

Adco. An English formula for converting in three to four months all kinds of vegetable wastes, composts, etc., into a clean, odorless, artificial manure by the addition of moisture and assisting beneficial bacteria. No equipment is necessary. Twenty-five pounds sufficient for twelve wheel-barrows full, \$2.00; 150 pounds, sufficient for a heap 10 x 10 x 6 feet, \$10.50.

Driconure. A high-grade, sterile, odorless, ready-to-use, dehydrated cow manure combined with peat moss. The value of these materials as a source of organic media, contributing active humus to soils, is well recognized. The composition is about thirty-five parts peat moss and sixty-five of cow manure. Put up in 50-lb. bags (about 3 bu.) \$2.50 per bag; ¼-ton, \$20.00; per ton, \$75.00.

Platco. 4-8-7. A high-grade complete fertilizer for general purpose, especially potatoes and garden truck crops. Price per 5 lbs., 25c.; 10 lbs., 50c.; 25 lbs., \$1.00; 100-lb. bag, \$3.00; per ¼-ton, \$12.50; per ton, \$38.00.

Platt's Special Lawn Fertilizer. Contains 10% Nitrogen, 5% Phosphoric Acid and 5% Potash. It is economical because it requires only 12½ lbs. per 1,000 sq. ft. This fertilizer is a new combination based on the weedless lawn principle of maintaining a slightly acid condition in the soil, thereby discouraging many troublesome weeds. Price per 12½-lb. bag, \$1.00; 25 lbs., \$1.75; 50 lbs., \$3.00; 100 lbs., \$5.00; ¼-ton, \$20.00 1 ton, \$75.00.



Pure Pulverized Sheep Manure. A safe natural manure for plants. A valuable supply of organic plant food. Its effect is immediate and lasting. Excellent for mixing with the soil for greenhouse plants (one part manure

and six parts soil). Broadcast in the vegetable garden, or placed directly in drills or hills, it promotes a rapid, steady growth until maturity. It makes rich, safe and quick liquid manure; one pound to five gallons of water can be used daily, if necessary, with safety. Price: 5 lbs., 25c.; 10 lbs., 50c.; 25 lbs., 1.00; 50 lbs., \$1.60; 100 lbs., \$3.00; 500 lbs., \$13.50; one ton, \$50.00.

Floranid. "It's Nitrogen from the Air." Contains 46% available Nitrogen. New, concentrated and economical for flowers, vegetables and shrubs. Price: 1 lb. 25c.; 5 lb. bag, 90c.; 10 lbs., \$1.50; 25 lbs., \$2.75.

Nitrophoska. Highly concentrated; formula 15-30-15. Contains 3 to 4 times as much as ordinary fertilizer. Price: 1 lb., 25c.; 5 lb. bag, 90c.; 10 lbs., \$1.50; 25 lbs., \$2.75.

Ground Bone. A special 3.29% nitrogen, 22.00 T.P.A. unsteamed, high grade for roses, grape vines, shrubs, lawn and florists' use. Prices: 5 lbs., 40c.; 10 lbs., 70c.; 25 lbs., \$1.35; 50 lbs., \$2.50; 100 lbs., \$4.00; 500 lbs., \$17.50; ton, \$65.00.

Regular grade: 2.05% nitrogen, 22.90 T.P.A. per 100 lbs., \$3.50; 500 lbs., \$14.00; ton, \$45.00.

Lime. Ground Limestone. 40 mesh. Price per 100 lbs., \$1.00; per ton, \$10.25. In burlap bags.

Land Plaster or Gypsum. It is an excellent addition to land requiring lime and sulphates, particularly for such crops as turnips, potatoes, grasses and clovers. Quantity required, broadcasted and harrowed in, one-half to one ton per acre. Price per 100-lb. bag, \$1.25; per ton, \$19.00.

Hard Wood Ashes. Contains all fertilizing elements except nitrogen. They drive away insects, and are beneficial for all crops requiring potash. They are also very good for garden and field crops, and are of high value for cabbage, potatoes, onions, strawberries, fruit trees, grasslands and lawns. Apply one or two tons per acre. Price per 100 lbs., \$2.50; per ton, \$40.00.

Nitrate of Soda. This is valuable solely for the nitrogen it contains. It is very quick in action and hastens the maturity of the crops. Being extremely soluble, it should not be applied until the plants are above ground, when one hundred to five hundred pounds per acre, mixed with wood ashes or land plaster, for convenience in applying, are generally used. Price per 5-lb. package, 40c.; 10-lb. package, 75c.; per 100 lbs., \$4.00; per ton, \$60.00.

Muriate of Potash. Eighty per cent pure, equivalent to 48 or 50 per cent actual potash. A high-grade fertilizer, and one of the best orchard fertilizers known. Especially adapted for all stone fruits and as a general fertilizer, muriate of potash and ground bone stand as leaders. Price per 5 lbs., 40c.; per 25 lbs., \$1.35; per 100 lbs., \$4.00; per ton, \$60.00.

Sulphate of Ammonia. Koppers (25% Ammonia). An improved product in fine condition. Price: 5 lbs., 40c.; 25 lbs., \$1.35; 100 lbs., \$4.00.

Superphosphate. Guaranteed 16% phosphoric acid. Per 100 lbs., \$1.50; per ton, \$22.70.

Salt for Asparagus and Other Crops. In sacks of 100 lbs., \$1.50. For quarter-ton or more, get special quotations.

Four Outstanding Products for the Better Care of Lawn and Garden.

Red Arrow Insect Spray.

An exceedingly powerful, non-poisonous, vegetable insecticide. Harmless to plants, harmless to the soil, harmless to children and pets, but deadly to insects. Red Arrow Insect Spray will not burn the tenderest leaf, blight the most delicate rose petal, nor mar the perfect whiteness of the most immaculate blossom. Red Arrow Insect Spray is a new weapon for the gardener in his fight with his insect enemies. It makes the greatest advance in agricultural insecticides in a generation.

The active ingredient in Red Arrow Insect Spray is derived from a daisy-like flower known botanically as *Pyrethrum Cineriaefolium*, grown extensively in Dalmatia and Japan.

It is the non-poisonous nature which gives it pre-eminence over other insecticides. It is absolutely harmless to plants or the higher animals. It can be used on fruits and vegetables just prior to their use for food with perfect safety.

Effectiveness of Red Arrow is quite remarkable. It kills by paralysis. Paralysis is not rapid in all cases but it is very sure and insects properly sprayed never recover. The spray kills by mere contact with the body of the insects; it is not necessary that it be eaten. It is fatal to both sucking and chewing insects.

Red Arrow is Economical and easy to use. The normal dilution is ½-lb. to 50 gallons of water or 1 oz. to 6 gallons. Mix fresh only sufficient for each day's use.

Prices: 1 oz., 35c.; 3½ oz., \$1.00; 8 oz., \$1.75; 1 qt., \$6.00; 1 gal., \$20.00.

Being a non-poison it can be sent by Parcel Post. Prices postpaid within third zone (300 miles): 1 oz., 42c.; 3½ oz., \$1.07; 8 oz., \$1.82; 1 qt., \$6.10; 1 gal., \$20.25.

Driconure.



The need for a high-grade, sterile, odorless, ready-to-use, dehydrated cow manure brought about the development of Driconure.

The ingredients are just manure from high protein fed cows and quality peat moss functioning as a humus making material and a reservoir for soil moisture. The composition is about thirty-five parts peat moss and sixty-five of cow manure—no straw, shavings or trash.

Driconure is an organic food for soil organisms, which make chemical fertilizing media available as plant food. Driconure being natural food for these organisms, they multiply rapidly, helping to pulverize the soil into a loam, thereby increasing aeration and water holding capacity. Driconure is concentrated five to one and will regain its original form when coming in contact with the soil mixture. It is easy to apply and easy to handle.

Packed in 50 lb. bags (about 3 bu.). Application—50 to 100 lbs. to each 400 sq.ft. for new seeding work or 50 lbs. as a top-dressing on lawns and gardens. Prices: 1 bag, \$2.50; ¼-ton, (10 bags), \$20.00; ton, \$75.00.

Platt's Special Lawn Fertilizer.

A better fertilizer for fine lawns. For more than twenty years tests have been run by the Rhode Island Experiment Station to determine the effects of different fertilizers. One of these formulae was called the weedless lawn fertilizer because of its nature in properly nourishing the grass and at the same time discouraging most of our troublesome weeds. This, of course, over a period of years, not immediate. Practically all fertilizers heretofore offered were either deficient in the proper plant food elements, neutralized the desired soil condition, or of poor mechanical condition. We have overcome these troubles in a convenient economical form; only 12½ lbs. per 1000 sq. ft. or 500 lbs. per acre are needed for general use to promote a luxuriant growth of beautiful color. A small trial is the most convincing proof of its exceptional value. Platt's Special Lawn Fertilizer is distinctly different from any other formula we know of, both in materials used and in ratio of plant food elements. It is a complete fertilizer for grass and not a mere stimulant. The guaranteed analysis is 10% Nitrogen, 5% Phosphoric Acid and 5% Potash.

It is impossible that a fertilizer for grass should be equally suited to trees, shrubs and flowers, as their requirements are different. In consideration of the small amount required the cost will be found very low. It should be applied evenly, much the same as grass seed; not like ordinary fertilizer.

Prices: 12½ lbs., \$1.00; 25 lbs., \$1.75; 50 lbs., \$3.00; 100 lbs., \$5.00; ¼-ton, \$20.00; per ton, \$75.

Peat Moss.

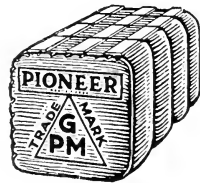

The greatly increased use of Peat Moss for horticultural purposes shows a better understanding of its value. Still there are many who have not yet become acquainted with its function of increasing soil fertility.

Fertility is dependent upon water, air, sunlight, temperature, plant food in the form of chemical constituency, soil bacteria and texture. No other medium now commonly added to soils contributes more toward gaining these physical factors than Peat Moss. It adds organic matter—contributing to the formation of humus; it makes the land more pliable and improves its general texture and condition. It also contributes effective drainage thus ventilating the soil. It is a reservoir for moisture and air and it is these two fundamental physical factors that probably regulate the functioning of all others toward productive fertility.

All Peat Moss is not alike. It differs in composition as well as stages of decomposition and all cannot be used advantageously in gardening. To cover more fully some of the interesting facts about the usefulness of G. P. M. Peat Moss (a uniform high-grade specially selected for horticultural use) a folder entitled "Peat Moss. Outline of Its Uses" will be sent free upon request. We are prepared to fill orders promptly for either single bales or car lots. Price per bale, \$4.00; 10-bale lots, at \$3.75 per bale.

"PLANET JR." FARM AND GARDEN TOOLS.

A complete catalogue containing a full line of Planet Jr. implements free upon application.

Planet Jr. No. 25 Combined Hill and Drill Seeder, Double Wheel Hoe, Cultivator and Plow.

As a drill it is almost identical with the Planet Jr. No. 4 Drill, and is thoroughly substantial and accurate in sowing all kinds of garden seeds in hills or drills.

As a Wheel Hoe it is identical with the Planet Jr. No. 12 Double Wheel Hoe, the very best machine on the market. The change from drill to wheel hoe takes but a moment.
Price: \$21.50

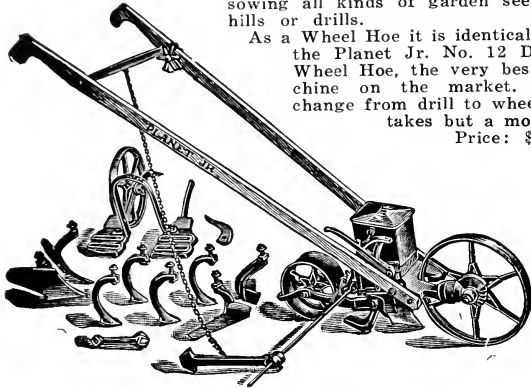

Planet Jr. No. 4 Combined Seed Drill, Single Wheel Hoe, Cultivator and Plow.

This is the most popular combined tool made. It combines in a single implement a first-class hill-dropping seeder, a single wheel hoe or weeder, a cultivator and plow. The hopper holds two quarts of seed, which can be sown in continuous rows, or dropped in hills, at 4, 6, 8, 12 or 24 inches apart.

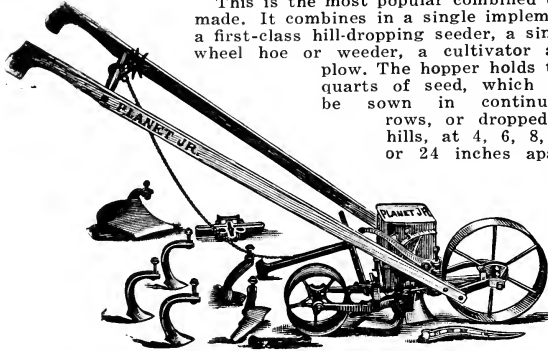

The drill is detached and the tool frame substituted by removing but one bolt. It then becomes a single wheel hoe.
Price: \$18.00. As a drill only, \$14.25

Planet Jr. No. 12 Double Wheel Hoe, Cultivator and Plow.

The No. 12 runs either astride or between the rows; kills all the weeds and leaves the earth in fine shape. Then, too, it is so easy to work.

The No. 12 has a pair of 6-inch hoes, a pair of plows for opening or covering, and a set of four all steel cultivator teeth. The tools shown are what gardeners use most, and others can be added.

Price: \$10.75

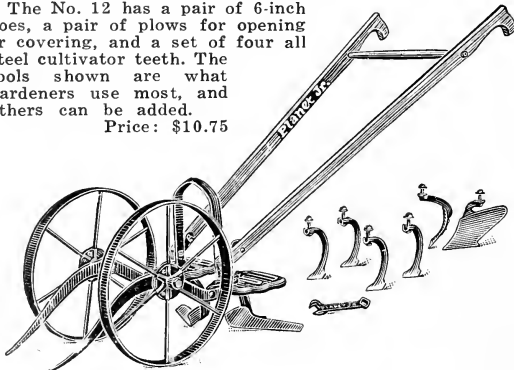

Planet Jr. No. 17 Single Wheel Hoe, Cultivator and Plow.

For easy gardening, and at the same time clean and perfect gardening, no tool is the equal of this No. 17 Wheel Hoe. It is suited to all kinds of garden cultivation and all garden crops. You can do more and better hoeing with it in one day than you can do in three days with a hand hoe. The No. 17 has a pair of 6-inch hoes, a plow and a set of cultivator teeth, an outfit sufficient for most garden work. Other attachments can be added at any time. Price: \$7.75

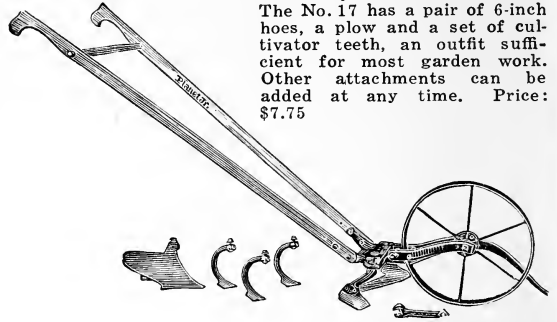

Ulrich Hand Cultivator.

This is the best tool of its kind we have ever seen, and we have tried out many. It has steel blades, which do much better work with less energy than the simply flattened and sharpened prongs used on others. A handy tool; should be used in every garden. Price: \$1.50

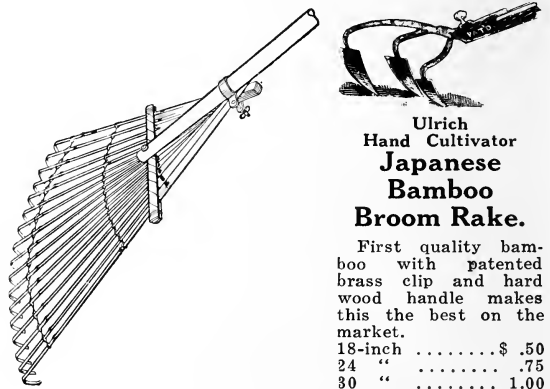

Ulrich Hand Cultivator Japanese Bamboo Broom Rake.

First quality bamboo with patented brass clip and hard wood handle makes this the best on the market.

18-inch \$.50
24 "75
30 " 1.00

The Cyclone Seeder.

The seeder that sows evenly, because, although simple, the features that have taken years to work out and combine the now perfected "Cyclone" with slant feed board, oscillating automatic feeder and shut-off, dished feed wheel and triple gears. Price: \$2.25. Mailing weight, 4 lbs.



The Cahoon Hand Broadcast Seeder.

For Sowing ANY Grain or Grass Seed

It has positive and accurate feed. Malleable iron frame, steel hopper and gate,

brass discharger. Price: \$5.25 each.

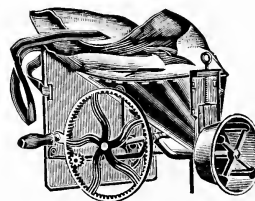

Blair Lawn Mowers.

The Automatic Nine-Four.

A High-Grade, Light-Running Lawn Mower. The Automatic 9/4 is equipped with Fafnir, ground race ball bearings, automatically adjusted; skeleton frame; nine-inch traction wheels; four drawcut wiper blades; malleable iron cutter heads, gear case covers and roller brackets; crucible steel, lipped edge stationary knife, automatically sharpened; truss knife bar, strong and rigid; mould fitted adjusting screws, will not loosen. A great Mower at the price. 16-inch cut, \$7.75.

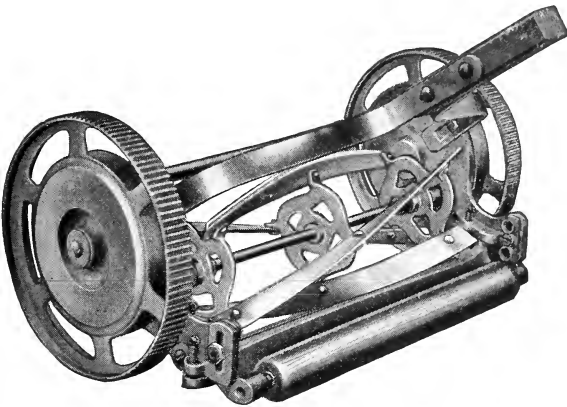
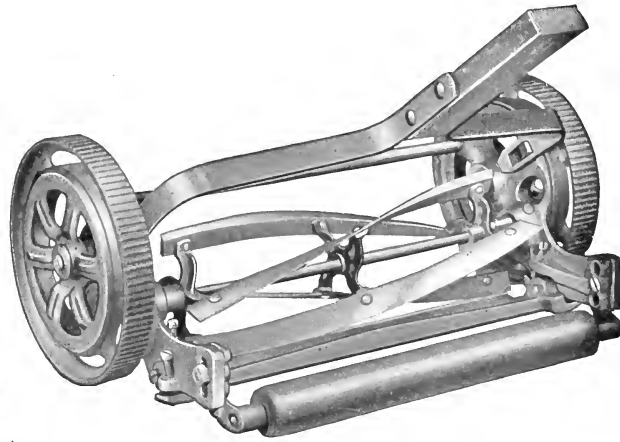

The Style E Moneyback Mower.

The Style E Moneyback Mower is a thoroughly high-grade machine equipped with self-adjusting Fafnir ball bearings; ten-inch traction wheels; four drawcut wiper blades and stationary knife, automatically sharpened; truss knife bar; mould fitted adjusting screws, will not loosen; malleable iron roller brackets and cutter heads. A universal favorite for average sized lawns. We have sold many Style E machines that have given more than eighteen years of good service. Price: 18-inch cut, \$9.75.

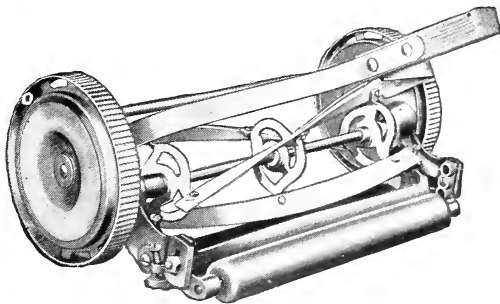

The Yankee Special.

The Yankee Special is a light, well-made Mower at a low price; fitted with plain bearings; eight-inch traction wheels; three drawcut wiper blades. The best possible value has been put into this machine for the money. Price: 14-inch cut, \$5.25.

See other mowers on inside front cover.

Cider and Wine Presses.

These presses are much stronger and more durable than those usually sold, well braced and nicely finished. All presses numbered 1 to 5 have iron cross piece and hinged tubs. The single tub mill and press combined will give satisfaction where its capacity is ample. Size of cage is 14 inches diameter by 12 inches deep.

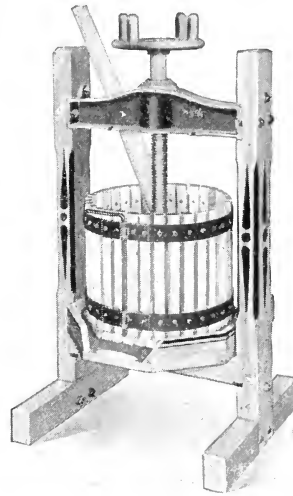

No. 3 Red Cross.

| | | |
|-------------------------------|---------|--------|
| No. 1 | 10 x 12 | \$9.00 |
| No. 2 | 12 x 14 | 12.00 |
| No. 3 | 14 x 17 | 20.00 |
| No. 5 | 21 x 18 | 31.00 |
| Prices quoted on application. | | |

Combined Cider Mill and Press

| | | |
|---------------|----------|---------|
| Single Tub .. | 140 lbs. | \$21.00 |
| Junior | 220 lbs. | 28.00 |
| Medium | 240 lbs. | 29.50 |
| Senior | 475 lbs. | 48.00 |

Automatic Corn Planter.

Can be regulated as to depth and amount of seed planted. Much more work, and with greater regularity, can be done than in the old way. Price: \$3.50

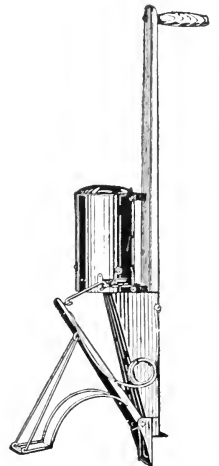

No. 3 Paragon Sprayer.

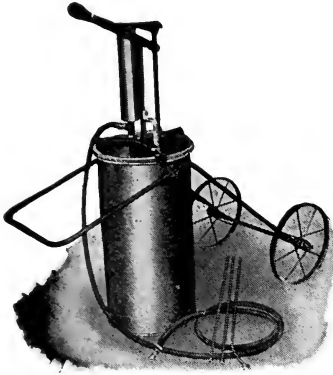

The Paragon No. 3 is a distinct improvement in sprayers of this type; first, in the large cylindrical strainer, which makes it practically non-clog. The agitator keeps solution thoroughly stirred. Pressure is kept up to a high point steadily because of large air chamber and great leverage. A well-made handy outfit. Equipped with 12-gallon tank and truck, three 2½-ft. extension rods, 10 ft. hose, two nozzles and shut-off.

Price: \$25.00

Gould's Pomona Spray Pump.

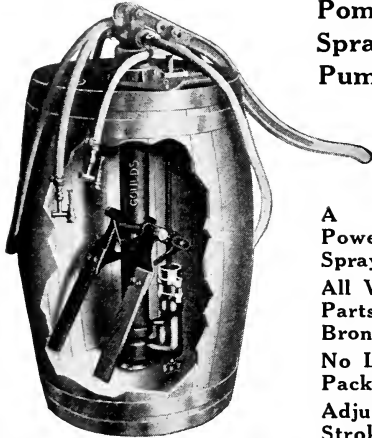

A Powerful Sprayer. All Working Parts Bronze. No Leather Packings. Adjustable Stroke.

The Pomona and Fruitall pumps are the result of long experience in the manufacture of spray pumps. They are strictly up-to-date and embody efficiency, durability and convenience. Price: Pomona Pump only, \$22.00; mounted on 50-gal. barrel, \$27.50.

Outfit P. A. Pump, not mounted, 25 ft. Bull Dog Hose, 10-ft. extension rod, with shut-off, one Friend nozzle, \$32.00.

If with shut-off at pump, add \$1.70. Barrel and mounting, \$5.50.

Fruitall similar to Pomona, but fastens to chime of barrel instead of head, and has two-inch cylinder. Price, pump only, \$12.00, with outfit same as for Pomona P. A., \$22.00. Barrel and mounting, \$5.50.

Auto-Spray Bucket Pump.



Auto-Spray Bucket Pump No. 60. A powerful, double-action bucket pump, capable of generating high pressure. All Brass construction of pump and valves means long life and freedom from rust and corrosion. Iron foot rest, 3 feet of ¾-inch hose and Auto Pop Spray Nozzle. Price, \$6.00.

The Auto-Spray No. 9.

Strong, Simple, Reliable.

For spraying trees plants and shrubs, white-washing, cold-water paints, etc. Tank capacity 4 gallons. Weight for shipment, 10 lbs. Equipped with hose, fine spray nozzle and auto pop shut off, also one 2-foot extension rod.

Price No. 9B. Brass Tank, with Auto Pop, and one extension rod, \$9.75.

Price No. 9D. Galvanized Tank, with Auto Pop, \$6.65.

Extra two-foot brass extension rods, 60c. each.

Elbow connections, 30c. each.



Vapor Bottle Spray.

A small sprayer fitted on a one-pint bottle, but constructed of high-grade materials and on the same principles as large, best-made sprayers; therefore, delivers a fine mist so necessary for fungi and insect control. Price, \$1.25.

Vermorel Knapsack Sprayer.

An imported French sprayer especially well and simply made, maintains high pressure so necessary for satisfactory results. Tank is copper. A clever cylinder strainer in the extension rod is a valuable feature.

Price, \$20.00



Wire Brushes.

for exterminating tent caterpillar nests. Price, 50c.

Spray Hose. See page 76.

Spray Nozzles.

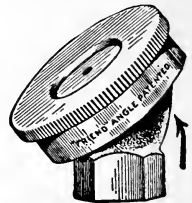
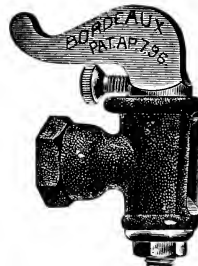

FRIEND ANGLE.

FRIEND NOZZLES do the work of two ordinary nozzles. Made of brass, in either straight or angle neck, with hardened tool steel disc placed into discharge cap and which can be removed and a new one inserted. Price for ¼-inch pipe, \$1.00; extra discs, 30c. dozen.

BORDEAUX NOZZLE, especially well adapted for white-wash spraying. Price, 90c.

Lowell Ideal Sprayer.

Ideal sprayers are strong, compact and handy, throw a good spray. Made in all tin, galvanized with tin tube, or all brass; length over all 20 1/4 inches. The No. 26AG, auto spray continuous compressed air is improved design, cleaned without the use of any tools.

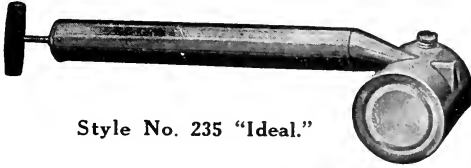

Style No. 235 "Ideal."

- No. 260. Tin Nu-Day 12-in., 1 pint \$.35
- No. 235. Ideal, all tin, 1 quart40
- No. 235G. Ideal, galvanized tank, in tube. .50
- No. 235B. Ideal, all brass70
- No. 50. Jaeckh. Copper continuous 2.25

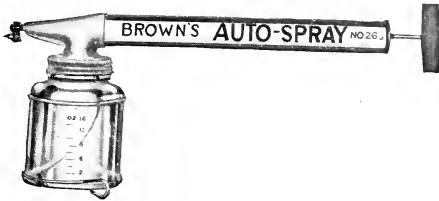

- No. 26AG. Auto Spray, glass tank, continuous, 1 quart \$1.15
- Mailing weight, 2 lbs. each.

Feeny Model "B" Duster.

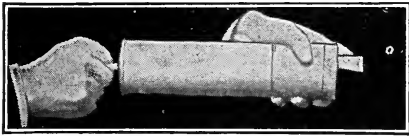

A great improvement in method of applying dust insecticides. Small, inexpensive, but large capacity. Price, "B", 12-in., \$1.25. Weight, 1 lb. "A", 22-in., \$2.50. Style "D", 2-qt. capacity, \$4.00.

Pruning Saws.

- Disston Duplex.** Double edged, 18-in., \$1.60.
- No. 7. Single edged, 18-in., \$1.50.
- Detroit Swivel,** 14-inch blade, similar to a butcher's meat saw, \$2.00.
- No. 50, **California Pattern.** Curved blade, 14-in., \$1.00.
- No. 111. Curved blade, 10-inch, with malleable iron socket for pole, \$1.75.
- Shipping weight pruning saws, 2 lbs., each.

Pruning Shears.

Only good shears.

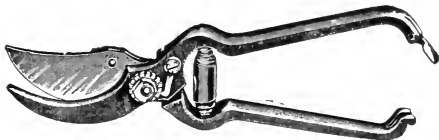

- No. 4671, 9-in..... \$1.00
- No. 4671, 8-in85
- No. 119 Snap-Cut 1.75
- No. 4673, 9-in. ... 1.75
- No. 109, Wiss..... \$3.50
- No. 4770, ladies.. 1.25
- No. 541, grape.... .60
- French 2.00

Tree Pruners.

Bartlett. Blades and head of drop forged steel, a good strong pruner. Price: 10 ft., \$4.00; 12 ft., \$4.25; 14 ft., \$4.50; 16 ft., \$4.75.

Waters. The old well-known pattern, much lighter than the above. Price: 8 ft., \$1.60; 10 ft., \$1.75; 12 ft., \$1.90.



Hedge Shears.

- No. 100, plain 9 in., \$3.00. No. 101, with notch for cutting branches, \$3.25.
- Wiss, 8-in., \$3.00 and \$3.25.
- No. 107, 5 1/2-inch, \$2.50.
- Border, No. 104, \$5.50; Border, No. 105, \$6.25.
- Lawn, No. 106, \$5.50; Lawn, No. 1062, \$7.00.

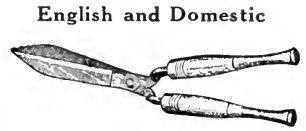

Simplicity Hedge Trimmer.

Cuts both opening and closing. Trimmer, \$3.50. Pruner, \$4.50.

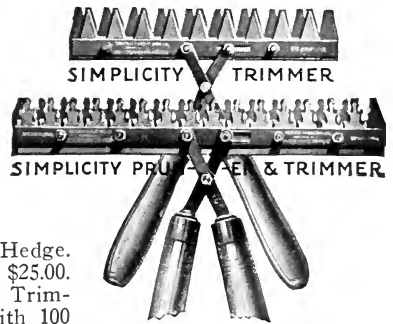

Little Wonder Hedge Trimmer 30 inch, \$25.00. Electric Hedge Trimmer "Skilsaw" with 100 ft. cable. Price on application.

Lopping Shears.

Are economically used for the removal of branches too large for the ordinary pruning shears, being much quicker than the saw.

Clyde. A powerful shear; easily cuts a broom handle. Price, \$3.25.

Tiffany Pruner. A high-grade, special steel lopping shear; easily cuts one-inch wood. Size 2, 34-inch, \$3.75. Disston No. 7, \$2.25.

Grass Shears, 3074E, \$1.00. Grass, 357, 75c.; No. 346, 50c.

Grass Snip, No. 117, 75c.

Doo-Klip, \$1.50.

Doo-Klip, Long handles, \$2.50.

Grass Hook, No. 2, 75c.; No. 414, 65c.

Scythes. Fine hammered steel. Blades, 32, 34 or 36-inch, \$2.00 each.

Snathes. No. 50, Grass, \$1.70; No. 105, Bush, \$1.90.

Grafting Blade.

One piece of forged steel—practical, compact, convenient. The best made tool for tree work. Each, \$1.00.

Trowbridge's Grafting Wax. 15c. per 1/4-lb., 25c. per 1/2-lb., 45c. per lb.

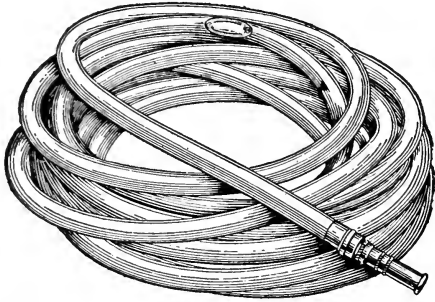

Garden Hose.

Bull Dog Hose. Improved especially for greenhouse use, and made in the $\frac{3}{8}$ -inch size, with $\frac{3}{4}$ -inch couplings of special design, allowing a full flow of water. The highest brand of multiple fabric garden hose, made of seamless rubber tubing, seven plies of closely woven light duck, well frictioned, and a real rubber cover. Price in 25 or 50-foot lengths, 20c. per foot.

Good Luck. This is a $\frac{3}{8}$ -inch hose, and will carry about 80 to 90 per cent as much water as $\frac{3}{4}$ -inch. On account of its slightly smaller size it gives economy of material to manufacturer. Every effort has been made to make this the biggest value in garden hose at the price obtainable. Equipped with standard $\frac{3}{4}$ -inch couplings. Price, in 25 or 50-foot lengths, 15c. per foot.

Platco Woven Hose. $\frac{3}{4}$ -inch. A high grade corrugated hose made in 500-foot lengths. Price, in 25 or 50-foot lengths and over, coupled, at 20c. foot.

Platco, half-inch, per foot, 17c.

Extra charge for coupling less than 25 ft., 25c.

Spray Pump Hose.

One-half inch. We offer one grade only which has been carefully made, especially for the purpose. "**Bull Dog.**" Per 100 feet, \$24.00.

For less than 25 ft., add 2c. per ft. Cut only in multiples of 5. Coupling extra; common, 50c.; long tail, 90c.

All Iron Hose Reel.

Holds 100 feet $\frac{3}{4}$ -inch hose. Has corrugated drum. Price, \$5.25. Reeleasy, \$2.00.

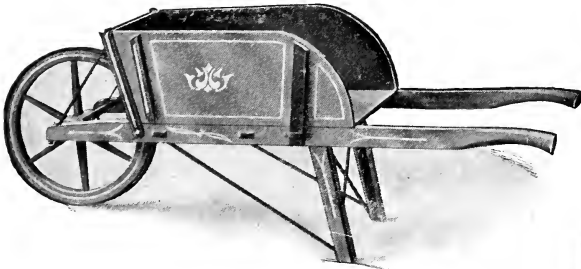
**Garden Barrows.**

Made from the best seasoned timber. The end of the bottom is cut into the back sill, thus preventing the splitting or breaking of the bottom boards. The wheel has a cast-iron hub with white oak or ash spokes and rims. The axle is wrought iron, with turned arbors. The whole barrow is reinforced and braced, making it light and especially strong.

Buch's Garden Barrow, No. 3, \$7.85.

Home Barrow. Metal tray, \$5.25.

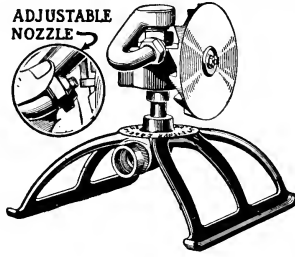
Double Rotary Lawn Sprinkler.

A Double Rotary Sprinkler does the work of several smaller sprinklers. Even with moderate pressure it will cover an area 75 feet in diameter, gently and thoroughly. Can be set for large or small area in less than one minute; no fine openings to clog; well and substantially made; especially valuable for golf greens and large lawns. Price, \$12.50.

Double Rotary, Jr. Price, \$7.50.

Whirling Showers. Price \$2.75.

Water Fans. Price, \$16.50.

Fountain Lawn Sprinkler.

Very simple and practical. Made in the form of a brass ring. Can be drawn over the lawn on the hose without detaching, and keeps right side up.

Price, 85c. each.

Elgin Lawn Sprinkler.

One of the best small sprinklers even under low pressure. A perfect spray. No moving parts.

Price, \$1.00.

**Rakes, Hoes, Spades and Shovels.**

Wood Rakes. 14 tooth, 85c.; 28 tooth, \$1.00.

Steel Garden Rakes, 12 tooth, \$1.10; 14 tooth, \$1.25; 16 tooth, \$1.35; 18 tooth, \$1.50.

Bow Handle Steel Garden Rakes, 14 tooth, \$1.50.

Steel Spades and Shovels, long or short handles. Lee, \$2.00. Ames, \$2.25.

Steel Hoes, 6-in, \$1.10, Socket, 7-inch, \$1.30; 8-inch, \$1.35; 9-inch, \$1.50.

Spading Forks, long or short handles, 4-tine, strapped, \$2.00; 5-tine, strapped, \$2.70.

Turf Edgers, Socket, \$1.35.

Light, for Frail Plants.

| Each. | Per 10. | Per 100 |
|--------|---------|---------|
| \$.11 | \$1.05 | \$9.75 |
| .08 | .70 | 6.50 |
| .05 | .40 | 3.50 |
| .03 | .20 | 1.80 |

Plant Stakes.

6 FT.

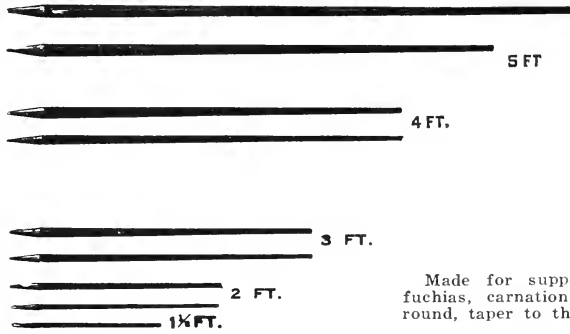

Heavy, or Dahlia Stakes.

| Each. | Per 10. | Per 100 |
|-------|---------|---------|
| \$.24 | \$2.20 | \$21.50 |
| .20 | 1.80 | 17.50 |
| .16 | 1.45 | 13.75 |
| .12 | 1.10 | 10.50 |

Made for supporting frail plants, such as fuchsias, carnations, tuberoses, etc. They are round, taper to the top, and are painted green.

Cane Stakes, Bamboo.

These are light and strong, uniform pencil thickness, dyed green, used extensively by florists.

| | |
|------------|------------------------------------|
| 2 ft. | per 1000, \$ 3.50; per 100, \$.50 |
| 4 ft. | 6.00 1.00 |
| 6 ft. | 12.50 1.50 |

Bamboo Tonkins. Natural color. Six feet long, 3/8-inch to 1/4-inch diameter, straight, strong and durable. Price, each, 8c.; per 100, \$6.00. Eight feet, per 100, \$7.00.

Cedar Bean Poles.

Good quality, heavy, 8 to 10 feet, sharpened, 20c. each; \$2.00 per ten, \$12.50 per 100.

Garden and Pot Labels, Painted.

| | Weight per 1000 | Per 10. | Per 100 | Per 1000 |
|-------------------------|-----------------|---------|---------|----------|
| 4 1/2 inch, 4 lbs. | | \$.05 | \$.25 | \$2.25 |
| 6 inch, 5 lbs. | | .06 | .35 | 2.65 |
| 8 inch, 13 lbs. | | .10 | .75 | 6.50 |
| 10 inch, 15 lbs. | | .15 | 1.00 | 8.50 |
| 12 inch, 19 lbs. | | .20 | 1.25 | 11.00 |

Postage extra.

Tree Labels, Painted.

Tree Labels, Painted. Notched and copper wired, 35c. per 100; \$2.50 per 1,000. Weight 4 lbs., per 1,000.

Improved Copper Tree Label. Size 1, 25c. per doz., \$1.60 per 100.

Shuffle Hoe. (English)

| | | |
|-------|-------|--------|
| 6 in. | 7 in. | 8 in. |
| 90c. | 95c. | \$1.00 |

Handle extra, 50c.



Ideal Weeder.

Price, each, 25c.

Magic Weeders.

| | |
|----------------------------|------|
| Style A Short Handle | \$15 |
| C | .30 |
| BB. 36-in. Handle, 3 tines | .30 |
| F. 42-in. Handle, 4 tines | .65 |



Asparagus Knife or Weeder.

Price, 35c.

Dibber.

No. 218, wood with iron point, 60c. No. 2180, brass point, 80c.

Garden Trowels.



No. 215, 20c.; No. 213, 15c.; No. 212, 25c.; No. 211, 60c. Hoe Trowels, 70c. Bulb Trowels, 85c. No. 217, Transplanting Trowel, 15c.

Cleveland Lawn Weeder.

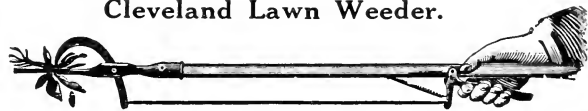

This little device gets at the root of the evil and removes it bodily. Price, \$1.25.



Price, 25c.

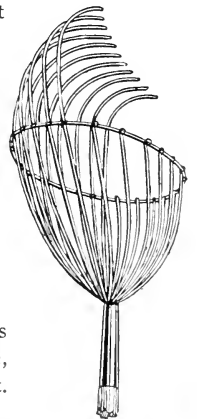

Perfect Fruit Picker.

Galvanized steel wire, attaches to pole of any length. Price, without pole, 60c. Price of 10-ft. pole, 50c.



"Out o' Sight" Mole Trap.

The secret of mole catching is a good trap and to know their habits. Full information sent with each trap. Price, each, \$1.25.

Thermometers.

We carry in stock a complete line of thermometers suitable for use in greenhouses, poultry and general work.

- 5120S 6-in. Household, wood back \$1.00
- 5154S 8-in. Coppered Case, Distance Reading75
- 5400S 8-in. Tin Case, Japanned... 1.50
- 5420S 8-in. Tin Case, Japanned... 1.00
- 5430S 8-in. Coppered Case 1.10
- 5440S 8-in. Tin Case25
- 5452S 8-in. Maximum and Minimum, Registering 7.00
- 5498S 10-in. Minimum Registering. 2.50
- 5981 15-in. Hot Bed 3.00

Incubator or Brooder, see Poultry Supplies.



Putty Bulb.

Price, \$1.50 each.



PUTTY BULB.

Garden Reels.

Iron Japanned (two arms), medium size, \$1.00 each.



Garden Line.

100 ft., \$1.00

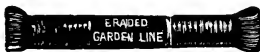

Jute Tying Twine.

Two, three or five-ply, 15c. per 8-oz. ball; 30c. per pound.

Many ends vegetable twine, 2- or 3-ply Jute, on reels of about 50 lbs. each. Write for prices.

Mastica.

For glazing greenhouses, sashes, etc. Elastic, adhesive and easy to apply. Far superior to putty. One gallon will cover about 300 running feet, one side. Price per gallon, \$2.50. Machines for applying Mastica, \$2.75 each.

Watering Pots.



| Quart. | Heavy galvanized. | |
|--------|-------------------|--------|
| 4 | | \$.65 |
| 6 | | .75 |
| 8 | | .85 |
| 12 | | 1.05 |
| 16 | | 1.50 |

Parlor. Tin, painted bright colors. Long, small spout. 2-quart. \$1.00.

Wotherspoon Watering Pots. Extra heavy and long spout, for greenhouse use.

| | Round. | Oval. |
|----------|--------|--------|
| 8 quart | \$5.00 | \$6.00 |
| 12 quart | 6.00 | 7.00 |

Raffia.

For tying plants, budding, etc., Raffia is superior to twine for bunching asparagus, celery, radish, cress, etc.

Price per lb., 35c.

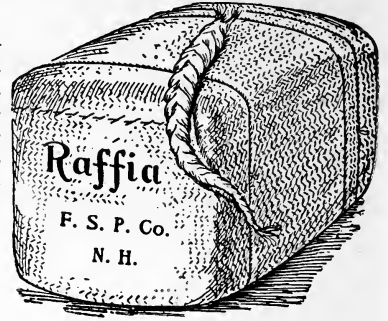

Van Reyper's Peerless Glazier Points.

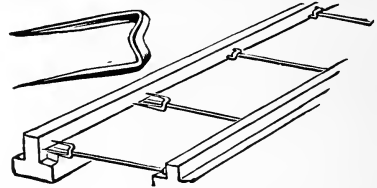

Made of steel wire and galvanized. Three sizes: No. 1 for small single thick; No. 2 for medium double thick; No. 2½ for large double thick glass. Per box of 1,000, 65c.; lots of 5,000 by express, 60c. per 1,000. Pincers for driving the points, 50c.

Acme Asparagus Buncher.

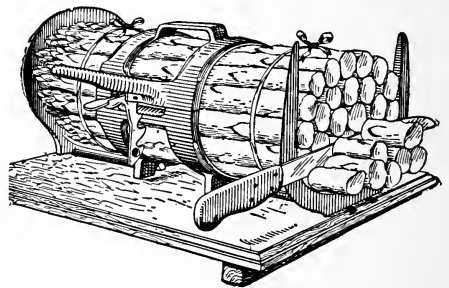

A great help to make bunches uniform and neat. Price No. 1, for 1-lb. bunches..... \$4.50
Price No. 2, for 2-lb. bunches..... 4.50

Hot Bed Sash -- Regular.

3 ft. 2 in. x 6 ft. Glazed, \$4.25. Painted one coat.

Hot Bed Mats.

Burlap exterior with felt filling, securely quilted and bound. An excellent winter covering for hot-beds, cold frames, in fact, anything requiring a heavy mat covering for winter protection, 76 x 76 inches, \$2.50 each; \$28.00 per dozen.

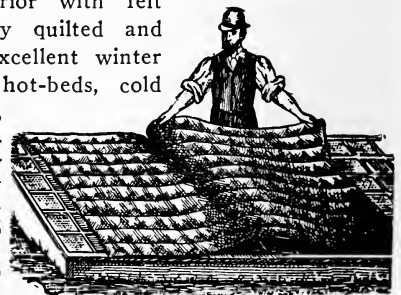

**"Neponset"
Paper Flower
Pots.**

| Size. | Per 100 | Per 1000 |
|-------|---------|----------|
| 2¼ | \$.45 | \$3.70 |
| 2½ | .55 | 4.30 |
| 3 | .75 | 5.85 |
| 3½ | 1.00 | 7.60 |
| 4 | 1.20 | 9.50 |
| 5 | 1.85 | 14.80 |
| 6 | 2.45 | 19.80 |

Postage extra.



Standard Flower Pots.

| In. | Per 1000. | Per 10. | Each. | In. | Per 100. | Per 10. | Each. |
|-----|-----------|---------|-------|-----|----------|---------|-------|
| 2 | \$11.25 | \$.12 | \$.02 | 8 | \$19.50 | \$2.00 | \$.22 |
| 2¼ | 12.75 | .15 | .02 | 9 | 30.00 | 3.25 | .35 |
| 2½ | 15.00 | .18 | .02 | 10 | 40.50 | 4.25 | .45 |
| 3 | 19.50 | .22 | .03 | 11 | 60.00 | 6.25 | .65 |
| 3½ | 24.00 | .25 | .03 | 12 | 82.50 | 8.50 | .90 |
| 4 | 30.00 | .35 | .04 | 14 | 135.00 | 13.50 | 1.35 |
| 5 | 54.00 | .55 | .06 | 16 | 300.00 | 30.00 | 3.00 |
| 6 | 81.00 | .90 | .10 | | | | |
| 7 | 135.00 | 1.40 | .15 | | | | |

Saucers.

| inches. | Per 100. | Per 10. | Each |
|---------|----------|---------|-------|
| 4 | \$2.25 | \$.25 | \$.03 |
| 5 | 3.00 | .35 | .04 |
| 6 | 4.50 | .50 | .06 |
| 7 | 6.00 | .65 | .07 |
| 8 | 8.25 | .85 | .09 |
| 9 | 11.25 | 1.20 | .13 |
| 10 | 13.50 | 1.40 | .15 |
| 11 | 16.50 | 1.75 | .18 |
| 12 | 20.25 | 2.10 | .22 |

Bulb Pans.

| inches. | Per 100. | Per 10. | Each |
|---------|----------|---------|-------|
| 6 | \$8.10 | \$.90 | \$.10 |
| 7 | 13.50 | 1.40 | .15 |
| 8 | 19.50 | 2.00 | .22 |
| 9 | 30.00 | 3.25 | .35 |
| 10 | 40.50 | 4.25 | .45 |
| 12 | 82.50 | 8.50 | .90 |

Fern Pans.

| inches. | Per 100. | Per 10. | Each |
|---------|----------|---------|-------|
| 4¾ | \$ 8.00 | \$.80 | \$.10 |
| 5½ | 10.00 | 1.00 | .12 |
| 6¼ | 12.00 | 1.20 | .14 |
| 7 | 14.00 | 1.40 | .16 |
| 8 | 20.00 | 2.00 | .22 |

Azalea Pots.

| inches. | Per 100. | Per 10. | Each |
|---------|----------|---------|-------|
| 4 | \$3.00 | \$.35 | \$.04 |
| 5 | 5.40 | .55 | .06 |
| 6 | 8.10 | .90 | .10 |
| 7 | 13.50 | 1.40 | .15 |
| 8 | 19.50 | 2.00 | .22 |
| 9 | 30.00 | 3.25 | .35 |
| 10 | 40.50 | 4.25 | .45 |

White Cedar Tubs.

Painted Green, with Feet.

| | | |
|---------|------------------------------------|--------|
| No. 1. | 12 inches top diameter inside..... | \$2.25 |
| No. 2. | 13 " " " " " " | 3.00 |
| No. 3. | 14½ " " " " " " | 3.75 |
| No. 3½. | 16½ " " " " " " | 5.00 |
| No. 4. | 19½ " " " " " " | 5.50 |
| No. 5. | 22 " " " " " " | 7.00 |

Growers' Tubs.

A good strong tub, lighter in weight than above; without feet or handles.

| | | |
|--------|------------------------------------|--------|
| No. 5. | 10 inches top diameter inside..... | \$.85 |
| No. 6. | 11 " " " " " " | 1.10 |
| No. 7. | 12 " " " " " " | 1.25 |
| No. 8. | 13 " " " " " " | 1.65 |

**Success
Flower
Boxes**



Success Plant Boxes.

Galvanized, painted green, and with patented lip so that it may be watered from the bottom to avoid surface soil hardening. Price: 24-inch, \$1.25; 36-inch, \$2.45.

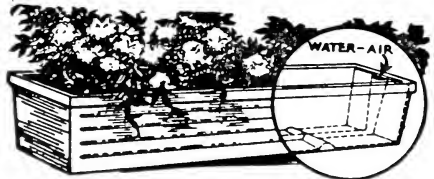

Perfecto Flower Boxes.

Perfecto Flower Boxes are new, self-irrigating, air-circulating and draining; attractively finished and, most important, grow vigorous plants. All sizes are 6 inches wide by 7 inches deep. Prices: 20-inch, \$1.00; 26-inch, \$1.50; 32-inch, \$2.00; 38-inch, \$2.50; 44-inch, \$3.00.



Hotkaps

New Method of Plant Protection

Hotkaps protect plants from frost, wind, rain and ground crusting. They produce quicker crops. You get higher prices. Thousands were used in 48 states last year. They cost so little that growers can not afford to be without them. Price: 1000 per package, \$11.50; 5000 lots, \$11.00; 10,000 lots, \$10.75. Steel Hotkap Setter, \$2.50. Trial package of 250 Hotkaps, including garden type Setter, \$4.00. Postage or Express extra. Weight 28 lbs. per 1,000.

Peat Moss.

Peat Moss is an organic material that contributes to the humus content of the soil. It is free from fungus, silt, sand or weed seeds, highly absorbent and retentive of moisture. It is used by gardeners and florists in a great variety of ways; such as, mixing with soil, propagating, mulching evergreens, roses, top dressing lawns, etc., which are covered more fully in a special folder, mailed upon request. G. P. M. Peat Moss is put up in machine-compressed, bales, burlapped, containing 20 bushels when loosened. The contents will cover 250 square feet, 1-inch deep. It is not sold by weight because that depends on the technical moisture content. Price per bale, \$4.00; 10-bale lots at \$3.75 per bale.

Garden Books.

For the amateur or professional.

Written by experts, the contents are dependable, covering subjects lucidly, thoroughly and yet concisely. Splendidly illustrated, well printed and well bound. Add 10c on paper-bound and 15c on cloth for postage. 32-page descriptive booklet sent free upon request.

The Book of Annuals, by Alfred C. Hottes. Complete manual (182 pages-155 illustrations) with full directions for culture and use of over 100 species. Cloth, \$1.50.

The Book of Perennials, by Alfred C. Hottes. Discusses over 125 separate species together with culture and requirements. Cloth, \$1.50.

Garden Guide. Condensed Cyclopedia of Gardening covering every step from spading the ground to harvest. 388 pages. Paper, \$1.00; Cloth, \$1.50.

1001 Garden Questions Answered, by Alfred C. Hottes. 320 pages up-to-date information for securing quick answers to garden questions. Paper, \$1.50; Cloth, \$2.00.

Milady's House Plants, by F. E. Palmer. Confined to plants tested to succeed in the home and treatment of such. Cloth, \$1.25.

The Woman's Flower Garden, by Jane Leslie Kift. 160 papers, numerous illustrations, on large and small gardens, indoor and outdoor. Cloth, \$1.25.

Birds of the Wild, by Frank C. Pellet. Story of personal experiences and observations over a period of 20 years. Illustrated. Cloth, \$1.75.

Practical Plant Propagation, by A. C. Hottes. Cloth, \$2.00.

Plant Culture, by George W. Oliver and A. C. Hottes. Cloth, \$3.50.



Flower Bed and Lawn Guard.

Constructed of heavy galvanized steel wire. "Cyclone" is crinkled and galvanized. Prices are per linear foot.

"Cyclone." 12 inch 10c.

Dunham Roller Bearing Water Ballast Lawn Rollers.

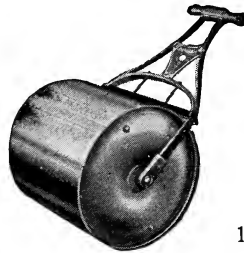

No. 5—Roller Bearing, 18 x 24 in., with no tip handle lock, \$19.00.

No. 7—Roller Bearing 24 x 24 in., with no tip handle lock, \$21.75.

No. 2—Plain Bearing, 14 x 24 in., \$12.75.

No. 4—Plain Bearing, 18 x 24 in., \$15.25.

Gator-Hide Mulch Paper.

The new method of growing Bigger Crops, Earlier and Without Weeds. Mulch Paper conserves moisture and stimulates growth. A circular giving more information will be gladly sent if requested. For general use we recommend the "B" (Heavy) grade; "A" (Light weight) grade is more for special crops. Price and contents per roll are:

| Type. | Width. | Length. | Price per roll. |
|------------------|--------|---------|-----------------|
| A (Light weight) | 18 in. | 900 ft. | \$3.50 |
| A | 36 | 900 | 7.00 |
| B (Heavy weight) | 18 | 450 | 3.50 |
| B | 36 | 450 | 7.00 |

Trial size roll, 18 inches wide, B grade, 45 feet long, Price, \$1.00.

For the Birds.

Canary and Rape. Recleaned, sweet and fresh mixed in proportion two-thirds canary and one-third rape seed. Per pt., 15c.; per qt., 25c.

Best Sicily Canary Seed. Per pt., 15c.; per qt., 25c.

German Rape. Per pt., 15c.; per qt., 25c.

Mixed Parrot. Price per pt., 15c.; per qt., 25c.

Millet, American. Price per qt., 15c.

Hemp Seed. Price per qt., 18c.

Sunflower Seed. Price per qt., 12c.

Maw Seed. (Poppy). Price per lb., 25c.

Thistle Seed. Per lb., 30c.

Padda or Unhulled Rice. Price per qt., 20c.

Bird Pep. Per roll, 15c.; doz. rolls, \$1.50.

Bird Gravel. Price per qt. box, 13c.

Cuttle Fish. Price, each, 3c.; 2 for 5c.; 1b., 70c.

Larger size, 5 to 6 inches, 5c. each.

Burnett's Song Restorer. Price per bottle, 25c.

Burnett's Bird Tonic. Price per bottle, 25c.

Fish Food, Wafer. Price per pkg., 10c.

Fish Food, Natural. Price per pkt., 10c.

Wild Bird Food. All whole seeds. Prices: 3 lbs., 25c.; 7 lbs., 50c., 15 lbs., \$1.00.



Grass Catchers.

Adjustable to any mower, "Easy Empty," \$1.25.

Bird Bath.

A hand-finished bird bath made of cast stone, with a sun dial effect. Size of bowl, 22½ inches diameter, height 29 inches. Price: \$15.00.

POULTRY SUPPLY DEPARTMENT

The following is a list of the most useful articles for the practical and successful poultry keeper. Look through this list. No matter how few chickens you keep, you will find labor and time-saving appliances. Parcel Post can be figured by weight given.

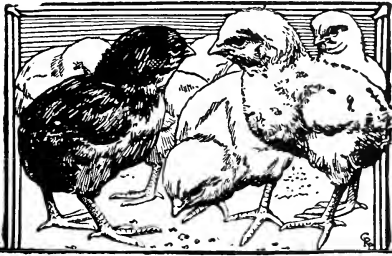

A Vital Subject

Our contracts with the breeders are for a certain number each week and there will be no surplus to draw on for that week. A 25% deposit with your order will insure your getting them when wanted.

"TOP GRADE ONLY"

Clean Chicks from Accredited Flocks.

The time has arrived when all distributors of Baby Chicks should indorse and support the efforts of the Connecticut Agricultural College Extension Service in stamping out Bacillary White Diarrhoea. Our Chicks are from State Accredited flocks only; flocks that have been blood tested for two or more years and found free from Bacillary White Diarrhoea.

The mortality in Baby Chicks from untested flocks may run as high as 100% and a 25% loss is of common occurrence. Serious as this is, there may be further losses in flocks infested with Bacillary White Diarrhoea through lower production and lowered resistance to disease.

| | |
|----------------------------|------------|
| Rhode Island Reds..... | Write |
| Barred Plymouth Rocks..... | for prices |
| White Plymouth Rocks..... | after |
| White Leghorns..... | Feb. 15th |

Buckeye Incubators.

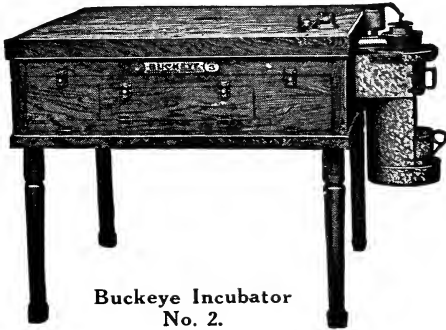

Buckeye Incubator No. 2.

Scientifically designed to hatch every hatchable egg.

By hatching more chicks—bigger, fluffier, stronger, healthier chicks—Buckeye Incubators quickly pay for themselves in the extra profits they make for poultry raisers. It's the extra chicks, the extra broilers and pullets which result, the extra returns over and above those otherwise obtainable—these are the considerations which have made Buckeye Incubators the undisputed leaders in hatching equipment.

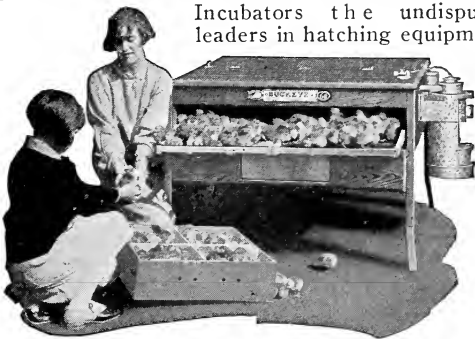

Buckeye Standard Colony Brooder.

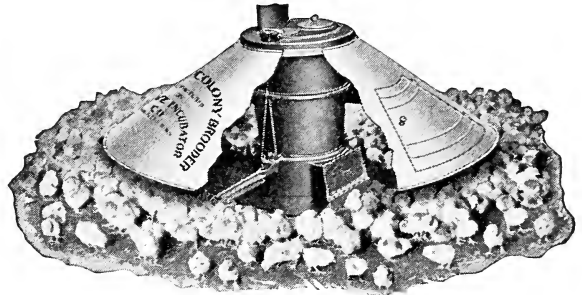

A remarkably efficient coal-burning brooder. A brooder that provides a constant, correct temperature, and a constant supply of pure, fresh air.

| | | |
|---------|---|---------|
| No. 117 | 350 newly hatched chicks (weight 74 lbs.) | \$15.00 |
| No. 118 | 500 newly hatched chicks (weight 94 lbs.) | 17.50 |
| No. 119 | 1,000 newly hatched chicks | 22.50 |
| No. 120 | 1,200 newly hatched chicks | 26.50 |

Newtown Colony Brooder.

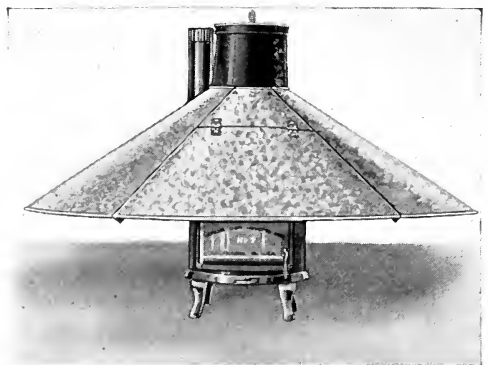

Every article bearing the name of "Newtown" is sold with the distinct understanding that it will give you the service you have a right to expect from a high-class product.

| | | |
|--------|---------------------------------|---------|
| No. 11 | 500 Newly hatched chicks | \$32.50 |
| No. 12 | 1000 Newly hatched chicks | 40.00 |

| | | |
|---------|-------------------------------------|---------|
| No. 2. | 175 eggs (shipping weight 129 lbs.) | \$35.00 |
| No. 3. | 250 " " " 170 " | 46.50 |
| No. 4. | 350 " " " 206 " | 55.00 |
| No. 65. | 75 " New Style | 18.50 |
| No. 66. | 143 " " | 39.50 |
| No. 67. | 286 " " | 57.75 |
| No. 68. | 416 " " | 76.50 |
| No. 69. | 576 " " | 97.50 |

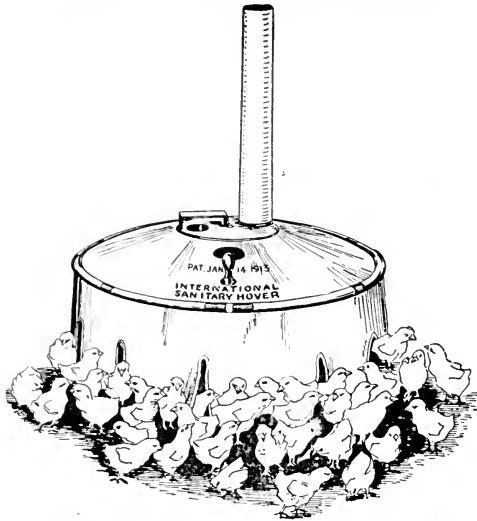
International Sanitary Hover.

The Sanitary Hover is a simple, safe, convenient and dependable oil-burning brooding device. It can be used anywhere that the chicks have protection from wind and rain. Warmest at the curtain, which means healthy chicks and no crowding. Capacity, 100 chicks; shipping weight, 25 lbs. Price: \$13.50.

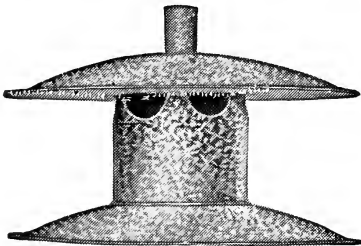
Putnam Brooder Heater.

This heater used in the Putnam Home-made Brooder requires filling but once a week, and no further attention in the meantime. The construction of the brooder stove acts like an open fireplace, carrying the foul air out and drawing fresh air in. Capacity, 25 to 50 chicks. Price: \$4.75.

Electric Egg Candler.

Plug
In Any
Lamp
Socket

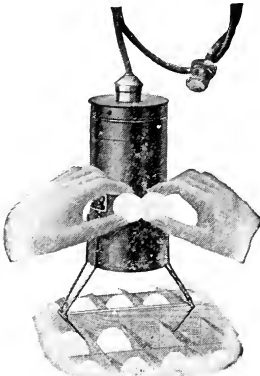

Clamps
Right
On
Your
Egg
Case

Price \$4.75. Shipping weight, 2 lbs.

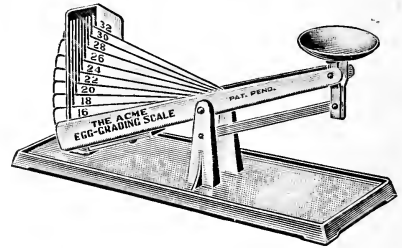
Acme Egg Grading Scale.**AUTOMATIC ACCURATE**

The Acme Egg-Grading Scale is made entirely of aluminum, which makes it rust-proof and practically indestructible. Every part is accurately made and carefully tested and will meet the requirements of any state bureau of weights and measures. Price: \$2.85; No. 1, 16-oz. to 32-oz.

Incubator and Brooder Supplies.

Incubator Lamp Bowls, \$1.00 each.
Burners, No. 2, sun hinge, 1-in. wick, 50c.
Burners, No. 32, sun hinge, 1-in. wick, 50c.
Burners, No. 30, sun hinge, 1½-in. wick, 75c.
Burners, Skirt, No. 2B, for Zero Lamp, 1-in. wick, 50c.
Burners, Buckeye, Gas, with chimney, for incubators or brooders, \$2.00 (2 lbs.)
Lamp Wicks, ½-in., for four heaters, 3 for 5c.
Lamp Wicks, 1-in., 2 for 5c.
Lamp Wicks, 1½-in., 2 for 5c.
Thermometers, No. 5776 "Tycos" Incubator, 75c.
Thermometers, No. 5794, Brooder, 75c.
Thermometers, No. 120, Incubator standing, 75c.
Thermometers, Buckeye Incubator, \$1.00.
Thermometers, International Hover, 75c.
Wicks, Buckeye Oil Brooder No. 27A, 30c.
Wicks, Buckeye Oil Brooder, Nos. 28A and 29A, 50c.
Wicks, Newton Oil Brooder, No. 331, 50c.
X-Ray Egg Tester, to use on lamp, 50c. (½-lb.)
Buckeye Egg Tester, 50c.
Waterproof Sheeting, one yard wide, 25c. yard.

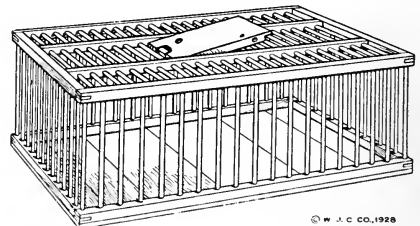
Hickory Rod Shipping Crate.

Light, strong and durable. Made of hickory rods with poplar frames and bottom, solid side spring door that can be sealed against theft in transit. Broilers cannot get out of this coop between the rods. Made to comply with new Express Regulations. Capacity, 12 to 15 fowls. Dimensions 14" x 24" x 36." Weight, 15 to 18 lbs. Price: \$1.85 each. \$21.00 per dozen.

PLATT'S POULTRY FEEDS.

There is to-day no subject of more vital importance to poultry-keepers than how to get the maximum number of eggs from their flocks, and how to raise baby chicks properly.

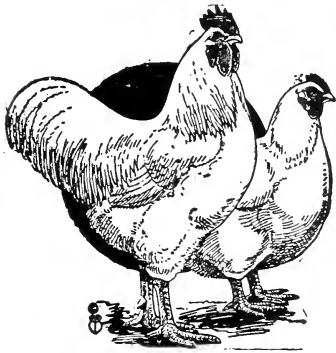

Platco Dry Mash and Scratch Feed.

Platco Laying and Growing Mash is a mixture compounded from the formula recommended by the Cornell Poultry Experiment Station. Several years ago we tested a flock of pullets with this mixture for one year, and the results were such that we immediately started manufacturing it. It has given marvelous results as a Growing Food, owing to its high protein content.

Platco Scratch Feed is composed of the highest quality of clean, sound grain, mixed from formulas to balance our mash.

Conkey's Y-O

Yeast with Cod Liver Oil.



Y-O is a smooth brown powder in which Marmite yeast and cod liver oil is combined —by a special sealing process—in a highly concentrated form, whereby vitamins A, B, and D retain their potency over a long period of time. Y-O is Nature's own storehouse of vitamins A, B, and D, plus man's ingenuity in concentrating their numbers and prolonging their effectiveness.

Marmite yeast is obtained from Brewers' Grains and should not be confused with bakers' yeast. The vitamin B potency of Marmite yeast is far more virile than that found in the raw bakers' yeast, hence experimental work done with bakers' yeast has no bearing whatever on Marmite yeast; the latter having passed the experimental stage and is now recognized for its lasting potency of vitamin B.

PRICES: Pkgs., 1 lb., 55c.; 2 lbs., 90c.; 5 lbs., \$2.00; drums, 25 lbs., \$7.50; 50 lbs., \$14.00; 100 lbs., \$22.50.

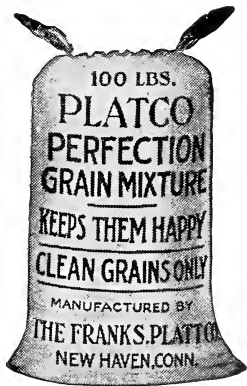

Platt's Pigeon Feed.

- Kaffir Corn.
- Alfalfa, Mealed.
- Beet Pulp.
- Conkey's Buttermilk Starting Food.
- Bran, Wheat.
- Clover, Short Cut.

Corn, Whole.

- Oats.
- Wheat, Red.
- Buckwheat.
- Beef Scrap.
- Fish Scrap.



Bone Flour.

Bone, Granulated and Mealed.

Semi-Solid Buttermilk. Price upon application.

Grit.

A hard limestone in sizes No. 1 for turkeys, No. 2 for fowl, No. 3 for pigeons, No. 3½ for chicks.

Price: 10 lbs., 20c.; 100 lbs., 90c.

Conkey Buttermilk Starting Feed.



Conkey's
TRADE MARK
THE ORIGINAL
Buttermilk
STARTING FEED



Now Contains
CONKEY'S Y-O
(Yeast with Cod Liver Oil)

Charcoal.

Fine, Medium or Coarse,
2 lbs., 15c.; 5 lbs., 30c.
Also 50-lb. bags.

Oyster Shells.

Comes in poultry and
pigeon size; 100 lbs., \$1.30;
10 lbs., 25c.

OWING TO MARKET FLUCTUATIONS PRICES OF FEEDS ARE SUBJECT TO CHANGE.

Handy Fill Chick Fount.

Made of heavy galvanized iron in two pieces. The top is made with two way swinging bail which permits fountain to be carried either filled or in filling position. Easy to fill — Easy to clean. Capacity, 3 gallons. Price, \$1.50 each.

Royal Chick Feeder.

These troughs are made of 135-lb. charcoal tin, which is the best material that can be secured for a buttermilk trough. No. 324, length 24 in., 50c.

Gem Chick Fountain.

A good inexpensive fountain for chicks or grown fowl. Made of galvanized steel, accurately stamped and formed. Easy to fill and clean. Price: 1-gal. size, 50c.; 2-gal., 80c.

Royal Fount.

Made from heavy galvanized iron. Double tank construction. Top fill; grown fowls or chicks can drink all around. Capacity, 3 gallons. Price: \$1.75 each.

No. 205, 5-gal. size. Price: \$2.40 each.

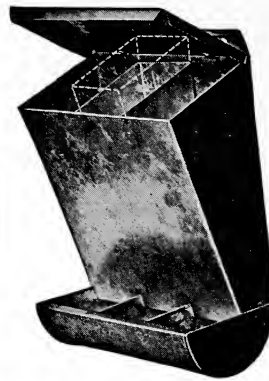
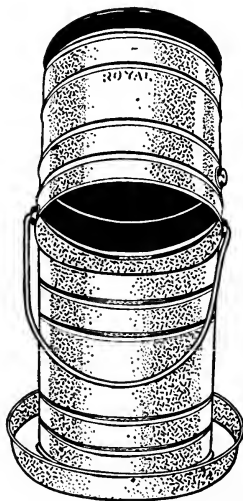
**Self-Feeding Boxes.**

Three compartments, each holding about three pints, for grit, shell and charcoal. Shipping weight, 5 lbs., Price: No. 2, \$1.25.

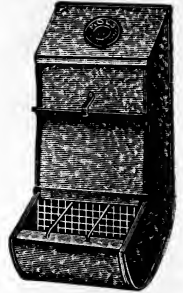
**Improved Handy Dry Mash Hopper.**

Has an adjustable grid for fine or coarse mash. The flange on each side and wires extending to grid prevents birds throwing feed sideways out of the hopper. Prices: No. 36, 12-in. (shipping weight, 8 lbs.), \$1.75; No. 37, 24-in. (shipping weight, 12 lbs.), \$2.80.

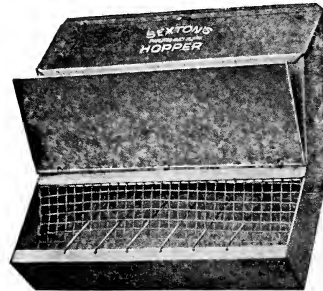
Sexton Dry Mash Hopper.

No. 5
No. 5, 24-in. (shipping weight, 13 lbs.), \$2.95 each.

Will save its cost in feed in one winter. This is a most economical hopper for feeding dry mash and keeping it sweet and clean. Price: No. 1, 12-in., (shipping weight, 9 lbs.), \$1.65 each.

Rabbit Feeders.

These are made of earthenware, glazed, and hold one quart. Price, 25c. each; \$2.75 per doz.

Wall Founts.

One of the most popular styles of drinking founts, convenient, sanitary and made from heavy galvanized iron. Price: 4-qt. (shipping weight, 4 lbs.) 95c.; 8-qt. (shipping weight, 5 lbs.) \$1.15.

No. One-Forty Feeder.

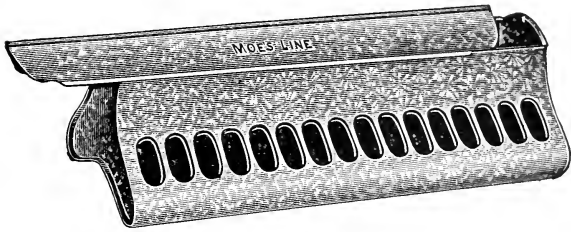

This is a large capacity feeder made to care for large or small flocks. Made of heavy galvanized iron, capacity 10 quarts. Price: \$1.00.

No. 141, capacity 17 quarts. Price: \$1.60.

Seamless Galvanized Cups.

Used for feed and water in exhibition coops. Price: medium size, 25c. each; large size, for pens, 30c. each. Shipping weight, 1 lb. each.

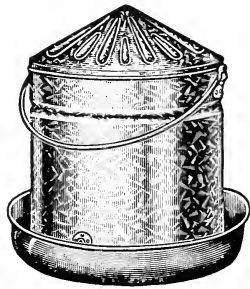
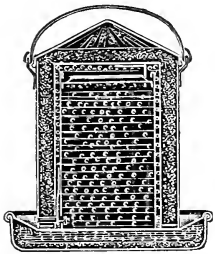

Keep Warm Thermo Fountain.

Insulating jacket or outer tank of Keep Warm Thermo Fountain is an inch thick—all the way down. The top is insulated. There is also complete layer of insulation as well as a dead air space below and around the water in the pan. Water heated to 110 degrees will not freeze in this fountain in very severe weather. 3-gal size, \$4.20; 5-gal. size, \$5.10.

Little Putnam Stove.

The Little Putnam Stove is used under the drinking vessel in the poultry house to keep the water from freezing during the winter months. It is also used as the heat element in the Putnam Home-made



Oat Sprouter. This stove is absolutely fire-safe and non-explosive. If it is tipped over it will go out. Price: galvanized, \$2.00 each, postpaid.

Sanitary Stoneware Founts.

Thoroughly glazed inside and outside. Being made in two parts, they can be easily cleaned. Will never rust, but will keep water pure, clean and cool.

Price: 1-qt., (shipping weight, 6 lbs.), 40c.; 2-qt. (shipping weight, 8 lbs.), 50c.; 4-qt. (shipping weight, 12 lbs.), 65c.



SANITARY TWO-PIECE.

Duplex Fount.

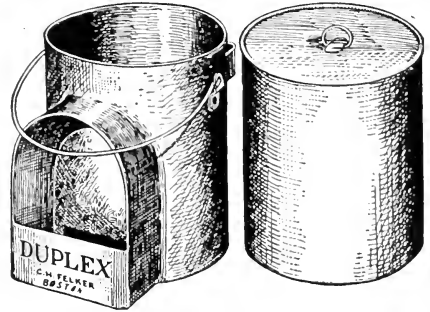

Made in two parts. Quickly cleaned. Price: 1-gal. size (shipping weight, 4 lbs.), \$1.15; 2-gal. size, (shipping weight, 5 lbs.), \$1.40; 2-gal. two pen, \$1.65; 5-gal., two openings, \$3.00; 5-gal., two pen, \$3.00.



EVERETT.

The Everett Fountain.

A fount that is easily cleaned. Made of heavy galvanized. Price: \$1.45 each. Shipping weight, 5 lbs.

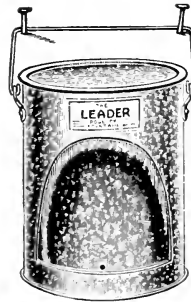

Leader Founts.

A new Sanitary Fountain. Easy to keep clean. Made of heavy galvanized iron in two pieces. The three-gallon size has two drinking spaces.

One and one-half gallon size, price, 85c.

Three gallon size, price, \$1.50.

Peerless Founts.

Brooder size, (shipping weight 2 lbs.), 35c. each.



Square Pan Oat Sprouter.

Has five perforated pans, each 16 x 18 inches, and one drip pan at bottom. Price: \$5.50.

The Collins Sprouter.

Two sizes. Four and seven perforated pans and one drip pan 11 x 15 inches. Prices: Five pans, \$3.00; eight pans, \$4.00.

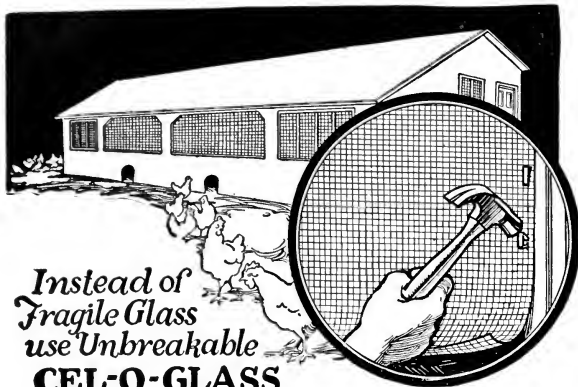

Instead of Fragile Glass use Unbreakable **CEL-O-GLASS**

No more broken chicken house windows when you use CEL-O-GLASS. This material is far better than glass because it is very light in weight, weatherproof and coldproof and is absolutely unbreakable.

CEL-O-GLASS lets in practically as much light as clear glass. It spreads the light evenly so that there are no dark shadows anywhere. It breaks up the direct sun rays and diffuses the light, and for this reason variation in temperature is reduced to a minimum.

Full rolls are 100 lineal feet, 3 feet wide. Price, full rolls, 13½c. per sq. ft.; less full rolls, 14½c. per sq. ft. F. O. B. New Haven. Circular mailed upon request.

Glass Cloth.

Glass Cloth is a strong fabric treated by a patented process to make it transparent, weather-proof and water-proof. It costs much less than glass and for many purposes is superior. Anyone can put it up. It admits abundant light, which it diffuses and scatters to all parts of the enclosure. It comes in rolls 36 inches wide and any length.

Prices: 1 to 6 yds., 40c. yd.; 6 to 10 yds., 37½c. yd.; 10-yd. rolls, \$3.50; 15-yd. rolls, \$5.00; 100-yd. rolls, \$30.00. F. O. B. New Haven.

Metal Egg Crates.

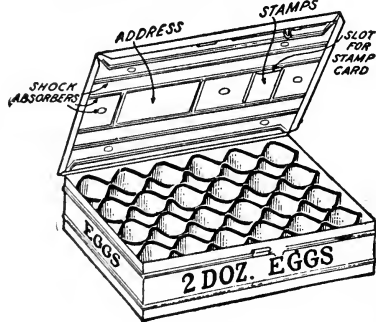

Solve the problem of shipping eggs by parcel post. These have shock absorbers to give a cushion for the eggs.

| | | | |
|--------------------|--------|---------------|------|
| 12-egg size | \$1.00 | Postage empty | 9c. |
| 18-egg size | 1.25 | Postage empty | 9c. |
| 24-egg size | 1.50 | Postage empty | 9c. |
| 36-egg size | 1.75 | Postage empty | 10c. |
| 48-egg size | 2.00 | Postage empty | 11c. |
| 72-egg size | 2.50 | Postage empty | 12c. |
| 108-egg size | 3.25 | Postage empty | 14c. |
| 144-egg size | 4.00 | Postage empty | 16c. |
| 180-egg size | 4.75 | | |

Include postage charges if to come by mail.

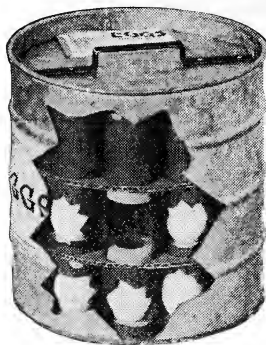

The Flesher Parcel Post Egg Carrier.

Has proved to be very satisfactory in the shipping of eggs by mail. The case is made of heavy galvanized iron and each egg is suspended in cylindrical cardboard containers.

Prices.

| | |
|-------------------|--------|
| 2-Doz. size | \$1.25 |
| 3-Doz. size | 1.50 |
| 4-Doz. size | 1.75 |
| 6-Doz. size | 2.50 |
| 8-Doz. size | 3.00 |

Parcel Post Egg Boxes.

The maximum of lightness and great strength combined. Made of corrugated fibre boxboard.

| | Price each | Price per-10. | Price per-100. | Weight per doz. |
|-------------|------------|---------------|----------------|-----------------|
| 1 doz. | \$.13 | \$1.15 | \$10.65 | 8 lbs. |
| 2 doz. | .20 | 1.75 | 16.25 | 10 lbs. |
| 3 doz. | .22 | 1.90 | 17.75 | 14 lbs. |
| 4 doz. | .33 | 2.85 | 26.60 | 18 lbs. |
| 5 doz. | .36 | 3.10 | 29.05 | 21 lbs. |

Include postage if to come by mail.

Egg Boxes and Chick Boxes.

Egg Boxes. For delivery to family trade; hold 1 dozen each. Convenient and economical. Price, 20c. per doz.; \$1.00 per 100; \$6.85 per 1,000.

Setting Egg Boxes. Made of corrugated paper, light but strong, and safe for mailing or expressing. Price: 15 eggs, 14c. each; \$1.18 per 10 (1 lb. each). 30 eggs, 20c. each; \$1.75 per 10 (2 lbs. each).

Shipping Chick Boxes. 25 chicks, 15c. each; 50 chicks, 22c. each; 100 chicks, 35c. each.

Water Glass Egg Preserver.

One-pt. can will preserve 10 doz. eggs. Price, 20c.
One-qt. can will preserve 20 doz. eggs. Price, 35c.
One-gal. can will preserve 80 doz. eggs. Price, 90c.

Caponizing Sets.

Poultry keepers can double their profits by caponizing their younger roosters. The operation is very simple, full directions accompanying each set. Caponizing changes the disposition of the fowl. He becomes lazy and puts on flesh astonishingly fast, often weighing 10 to 15 pounds. The demand far exceeds the supply, even though the price of capon is double that of ordinary fowls.

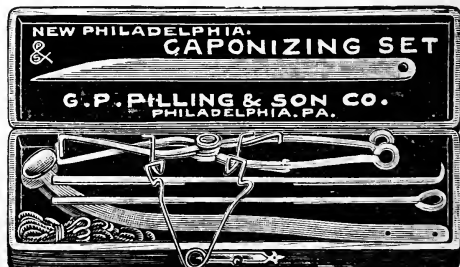

Price. Philadelphia, \$3.50.
Pilling-Miles, in velvet-lined case, \$5.00.

French Poultry Killing Knife.



This is made of finely tempered steel, with nickled handle, and will last a life-time. Price: 60c. each.

Pilling's Angular Poultry Killer.

By simply a turn of the wrist the jugular vein is severed, bleeding the fowl and making dry picking easy. Price: 60c. each.

Pilling Milking Tubes.

Plated. 1½ and 4¼ inches long. Price, each, 40c.

Wire Nests.

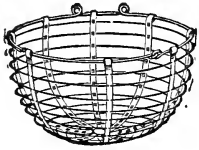

These nests are strongly made from heavy coppered wire and will last a life-time. They are intended to be fastened to the wall with screws or screw hooks. There is no room on them for the lodgment of lice or vermin of any kind; they are easy to keep clean and are far superior to wooden boxes. Price: 20c. each; \$2.00 per dozen.

Knudson Nests.

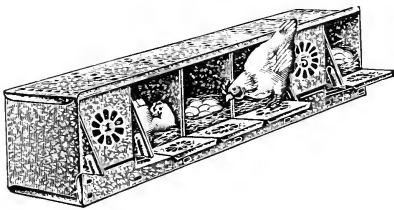

Made to hang on wall, galvanized iron, with swinging front doors. Complete two, three and six-nests in section. These nests are easily cleaned and are lice-proof, there being no hiding places for vermin. Price per two sections, \$2.25; per three-section, \$2.90; six-section, \$4.95.

Poultry Netting.

One or two-inch mesh, one foot to six feet high. Prices are the lowest when quality is considered. Will last twenty-five years under ordinary exposure. Prices quoted on application.

Double Clinch Bands.

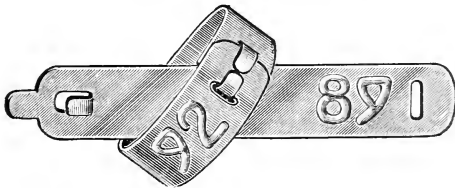

No tools required to put on these bands. They fasten with two clinches. There are no exposed corners, ends or loops. They are the best open band on the market. They are numbered consecutively. Sold in packages of 12, 25, 50 or 100 bands each; size 2 for leghorns, size 3 for Rhode Island Reds, etc., pigeon size same price. Prepaid, by mail or express. 12 for 15c.; 25 for 25c.; 50 for 35c.; 100 for 60c.; 250 for \$2.00; 500 for \$2.40; 1,000 for \$4.25.

Spiralet Leg Bands.



On and off like a key-ring. Ten different colors, with which you can make three hundred and twenty combinations. Several sizes. Price per doz., 15c.; per 25, 25c.; per 50, 35c.; per 100, 60c.; per 500, \$2.40; per 1,000, \$4.25.

Pigeon Nests.

These nests are moulded from clay, and are heavy, so they cannot tip over. They make the best nests for pigeons.

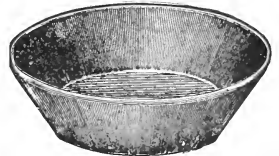

Prices: Each, 25c.; per six, \$1.40; per dozen, \$2.75.

Platco Roofing.

Manufactured from long fibre wool felt, thoroughly saturated and coated with natural Asphaltum, this combination making one of the most reliable weather-proof and durable coverings on the market. Nails and cement come inside each roll without extra charge. A roll (or square) contains 108 square feet, and will lay 100 square feet.



1-ply, 2-ply, 3-ply (fire-proof). Prices on application.

Five per cent Cash Discount on Ten Rolls Asphalt Roofing.

Pettey Chick Punch.



Is just right for the vest pocket. Nickel plated. Price, 25c., postpaid.

China Nest Eggs.

Price 30c. per doz.

Napthalene Nest Eggs.

Price, 5c. each; 50c. doz.

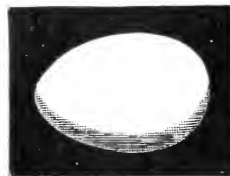

Lice Dusting Guns.

1-oz. size, 15c.;
2-oz. size, 30c.

K-R-O



Kill Rats Without Poison
A New Exterminator that Won't Kill Livestock, Poultry, Dogs, Cats, or even Baby Chicks
 K-R-O can be used about the home, barn or poultry yard with absolute safety as it contains **no deadly poison.**

2 oz. pkg., .75c.

Common Sense Rat Exterminator.

Destroys rats under all conditions. This is the best of the phosphorous paste compounds. Two sizes, 25c. and 50c.

Pastoxine.

The New Non-Poisonous Exterminator of Rats and Mice. Positively No Danger to Man, Domestic Animals or Poultry.

PASTOXINE is the latest achievement of Science for the promotion of health and sanitation. It is a Product of the "LABORATOIRE DES VACCINS PASTEUR, P. E.", Paris, France.

PASTOXINE possesses ingredients that are exceedingly appetizing to Rats and Mice, making Baits doubly effective. In many instances, the Rodents, scenting PASTOXINE, are attracted from their caches.

PASTOXINE develops symptoms that brings Rats and Mice out into the open to die, thereby eliminating obnoxious odors. 1 oz. jar, Price 50.; 2½ oz., \$1.00.



Dr. Hess Poultry Pan-a-Mim.

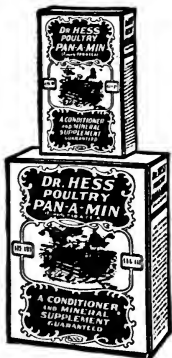

Aids digestion, makes poultry healthy, helps hens lay more eggs. Helps to fatten poultry for market rapidly and cheaply, and helps chicks reach maturity strong and healthy, cures poultry ailments; has been tested and tested for over nineteen years by farmers and poultrymen from coast to coast. Price: 3-lb. package, 50c.; 7-lb. package, \$1.00; 15-lb. package, \$2.00.

Conkey's Remedies.

Old Reliable Powder, (formerly Conkey's Roup Remedy), 25c., 50c., \$1.00, 1½-lb. can, \$2.35, 5-lb. can, \$5.50.

Conkey's Pills, 25c., 50c., \$1.00.

Balmo, (formerly Canker special), 50c. Diatex, (formerly White Diarrhea Remedy, 25c., 50c., \$1.00. Salvo, 25c.

Scaly Leg, 25c.

Poultry Worm, 25c., 50c.



Roto Salt Cakes for Pigeons.

25c. per cake.

Pratt's Poultry Regulator.

Price: 24-oz., package, 25c.; 4-lb. package, 50c.; 12-lb. package, \$1.40; 25-lb. pail, \$3.00 each.

"Gold Leaf" Tobacco Powder.

Controls poultry round worms. Recommended by a number of State Experiment Stations.

Price: 2-lb. package, 25c.; 10-lb. package, \$1.15; 100 lbs. in a burlap bag, \$6.00.

Lee's Gizzard Capsule.

A Positive Cure of Worms in Poultry.

The GIZZARD CAPSULE is a combination worm medicine for Round, Tape and Pin Worms, contained in an insoluble capsule. Being insoluble, this container keeps the medicine from coming in contact with the membrane lining of mouth, throat, crop or glandular stomach. In the gizzard the capsule is ground up, like a grain of corn, releasing the medicine, which quickly passes directly and in full strength into the intestines.

A medicine strong enough to get the worms may sicken a chicken, or may even cause injury to the delicate organs through which it must pass to reach the worm-infested intestines. The GIZZARD CAPSULE prevents all that. It does away entirely with the troubles incident to worm medicines through absorption by the mucous membrane of throat, crop, and glandular stomach. It further does not taint the meat of the fowl or the eggs; does not check growth, egg production, or fertility.

Adult Capsule: For chickens or turkeys half grown or older. 50-capsule package, \$1.00; 100-capsule package, \$1.75; 500-capsule package, \$7.00; 1000-capsule package, \$12.00; 5000-capsule package, \$55.00.

Chick Capsules. 50 for 50c.; 100 for 90c.; 500, \$3.50, 1000, \$6.00. Use one chick capsule for chicks 1 lb. to 2 lbs.; turks 3 lbs. to 4 lbs.; two capsules for chicks 2 to 3 lbs.; on larger breeds 2 to 4 lbs.; turks, 4 to 6 lbs.

Sawyer's Flucine.

For Treatment of ACUTE BRONCHITIS (Flu) in Poultry.

6 oz. bottle \$2.00—for 200 doses.
 16 oz. bottle 5.00—for 500 doses.

Flu-Koff Emulsion and Vapo-Spray.

Flu-Koff Emulsion and Vapo-Spray are two separate and entirely different medicines. Either can be used alone and each alone has proven a great remedy. Together, however, the two medicines comprise a double treatment, which is doubly effective.

Don't take any chances with flu. Give this marvelous double treatment. Don't delay. At the first wheezing, coughing, sneezing or gasping for breath, get busy. Take the trouble right in hand and avoid the later losses.

Every poultry raiser should always have Vapo-Spray on hand and use freely at first indications of any cold troubles. In case severe sickness develops without warning, the great companion medicine, Flu-Koff Emulsion, should be used in connection with Vapo-Spray, especially on individual birds that are very bad.

| | |
|-----------------------------|--------|
| FLU-KOFF, 12 oz. size | \$1.00 |
| " " 32 " " | 2.00 |
| VAPO-SPRAY, ½ gal. | 1.25 |
| " " 1 " | 2.00 |

Roto Salt Cakes and Feeders.

THE ROTO FEEDER is made of stone ware, exceedingly strong and simple.

Roto Salt Cakes, 25c. each; \$2.70 per doz.

Roto Feeder, 40c. each.

Square Salt Cakes, 25c. each; \$2.70 per doz.

Square Salt Cake Feeders (Belmont), 30c. each.



Dr. Hess Roup Cure.
Four-ounce can, 25c.

Lee's Germozone.

Roup, Canker, Swelled Head, Cold, Cholera, Bowel Complaint, etc., yield readily to treatment with Germozone. Especially valuable for little chicks. Put up in liquid form or tablets.

Price: 4-oz. bottle 40c.; 12-oz. bottle, 75c.; 1-qt. size, \$1.50; package of 75 tablets, 75c.; package 200 tablets, \$1.50. Tablets by mail, same price.



Smith's Roup Cure.

Is guaranteed and costs only 25c. and 50c. per box.

Smith's Germicide.

Four-oz. bottle, 35c.; 12-oz. bottle, 65c.

Sodium Hypochloride.



B-K is a powerful germ destroyer and deodorant. It is clear, colorless and non-poisonous. No disagreeable odor is left after use, yet it has ten times the germ killing power of pure carbolic acid. It instantly destroys the germs that cause disease, also odors, and prevents infection.

B-K is safe to use. It is easy to apply. It is economical.

Price: 10-oz. bottle. 60c.;

1 qt. bottle, \$1.25; 1 gal., \$3.00; 5 gals., \$12.50.

"Black Leaf 40."

CONTROLS POULTRY LICE.

"Black Leaf 40" painted on the top-side of the roosts will control body-lice. Saves the labor of handling each bird, either to dust, dip or grease. "Black Leaf 40" does not harm the birds nor retard egg production.

IT WORKS WHILE THEY ROOST.

One ounce of "Black Leaf 40" will "paint" about 12 or 15 running feet of roost; or one pound to 190 to 240 feet. "Paint" a thin film of "Black Leaf 40" on the top of the roosts and cross-arms, about half an hour before the birds perch for the night; on warm still nights in the Fall, Spring or Summer.

| | |
|---|---------|
| 10-lb. tin (Treats 1900 to 2400 running feet of roost) | \$11.85 |
| 2-lb. tin (Treats 385 to 480 running feet of roost) | 3.25 |
| 1/2-lb. bottle (Treats 90 to 120 running feet of roost) | 1.25 |
| 1-ounce bottle (Treats 12 to 15 running feet of roost) | .35 |

Dr. Hess Instant Louse Killer.

Lice simply cannot exist where this powder is properly used, either on poultry or live stock of all kinds. Price, 1-lb. pkg., 25c.; 2 1/2-lb pkg., 50c.

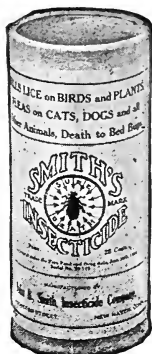

Smith's Insecticide.

Smith's preparation for this purpose is a standard, reliable article, well known and used by poultrymen the country over. Setting hens, well dusted twice during incubation, will not leave their nests on account of lice. Price: 5-oz. pkg., 15c.; 15-oz. pkg., 25c.; 38-oz. pkg., 50c.; 76-oz. pkg., \$1.00.

Smith's Flea Powder.

A high-grade powder, light in color, that will free dogs or cats from fleas and lice. Price, 2 1/2-oz. can, 25c.; 6-oz. can, 50c.



Head Lice Ointment.

The only practical method of exterminating the head lice. Powders have no effect on this specie, the largest blood-sucking louse that infest poultry.

Conkey's Lice Ointment. 1-oz. tubes, 10c.; 3-oz. tubes, 25c.

Smith's Lice Ointment, in screw-cap glass jar, 25c.



Sulphur Candles.

An easy, effective way to fumigate rooms or poultry houses. Easy to light. Water pans furnished with each candle. Price: Each, 10c.; per doz., \$1.00.

Lee's Lice Killer.

Is a liquid preparation for destroying insects on chickens, hogs and other stock. It was especially designed for killing lice and mites on chickens and hogs without the necessity of handling, dipping, dusting or greasing fowls or animals. Price of Lee's Liquid Killer: 1 qt., 60c.; 2 qts., 90c.; 1 gal., \$1.50.

Sturtevant Lice Paint.

Very effective for lice and vermin, also a disinfectant. Price: one quart, 60c.; one gallon, \$1.50.

Carbolineum.

Completely exterminates all lice and mites, also the best wood preserver. Rats or mice never gnaw wood painted with Carbolineum. Price: \$1.75 per gallon.

Dr. Hess Dip and Disinfectant.

For scab, mange, lice on sheep, fleas and all parasites, skin diseases of horses, cattle, sheep, hogs, dogs and poultry. Prices: 12-oz. 40c.; 1 quart, 65c.; 1 gallon, \$1.75.

Pulvex for Dogs.

The Popular Flea Powder

is based on an entirely different flea-killing principle. Its use always kills all the fleas and lice, instead of only stupefying them, allowing them later to revive and re-infest the animal. Pulvex not only kills the fleas and lice but keeps them off for 7 days or longer. Absolutely harmless, even if swallowed; non-irritating to the skin; Pulvex is ideal for cats and birds as well as dogs. Odorless, easy to use, economical, Pulvex will absolutely protect dogs, cats and birds against the discomforts and dangers of fleas.

2 oz. Sifter Top Can \$.50
12 oz. Package 1.25



Pulvex That Fine English Dog Soap.

—will not only free a dog of all its fleas and lice but grooms as it cleans. This soap contains the same active flea-killing agent found in Pulvex Flea Powder—one that positively destroys all animal parasites found on the animal. In addition, it contains oils hav-

ing a highly beneficial effect on the hide of a dog and giving the hair an attractive gloss and sheen. Pulvex Dog Soap comes in a beautifully enameled, hinged, metal container.

Cake (in metal container).....50c.

Kur-Maige.

Kur-maige is a fine powder, to be dissolved in water and applied either as a wash, bath or dressing. In addition to mange it is highly effective in curing many superficial skin diseases such as eczema and ringworm. Kur-maige kills fleas, lice, ticks and mites in a single treatment.

3 oz. (makes one gallon) \$.75
6 oz. (makes two gallons) 1.00

Antiseptic Animal Soap.

Kills fleas and bad odors. Keeps skin clean and healthy. Makes coat soft and glossy. Put up in two forms—cream in tubes, 35c.; liquid in can, 35c.

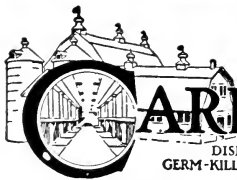

ARBOLA

DISINFECTING GERM-KILLING WHITE PAINT

Use It Instead of Whitewash.

A snow-white mineral paint in powder form, ready to be put on with brush or sprayer as soon as mixed with cold water. Contains the world's most powerful germicide—twenty times stronger than pure carbolic acid. Harmless to man or beast, but will instantly destroy lice, mites, nits. Price: 5 lbs., 75c.; 10 lbs., \$1.25; 25 lbs., \$2.75; 50 lbs., \$5.00.

Columbia Fly Killer.

Don't let your cows and horses suffer all summer long. Fly Killer will keep them away and make milking far more pleasant. Price: 1 qt., 60c.; 1 gallon, \$1.50.

American Squab Culture.

Cloth. \$2.00, postpaid.

A to Z of Pigeons.

Paper. \$1.00, postpaid.

American Standard of Perfection.

\$2.50 copy. Postpaid.

Dog Foods.

Kennel Food and Supply Co's. K. F. S. Square cakes with meat, 2 lbs., 25c.; 10 lbs., \$1.00; 25 lbs., \$2.00; 100 lbs., \$6.85.

Cero-Meato. Made of cereals, meat and bone. Price same as above.

Plain Broken Biscuit. This biscuit is made to feed with Perfect Condition Meat. 25 lbs., \$1.80; 50 lbs., \$3.35; 100 lbs., \$6.55.

K-9. A New Dog Food. Cereals, beef, vegetables, and Cod Liver Oil. 1 lb. cans, 15c. each, 2 for 25c. Case of 48, \$6.25.

Perfect Condition Canned Meat. This is 100% pure boiled heat, 40c. per can, 3 cans, \$1.10.

Bennetts Milk Bone. 35c. per package.

Cat Food. 15c. per package.

Rabbit Culture and Standard.

Paper. 50c., postpaid.

Reliable Poultry Publishing Company's Books.

Plymouth Rocks. Price, \$1.00.

Orpingtons. Price, 75c.

Wyandottes. Price, \$1.00.

The Leghorns. Price, \$1.00.

Artificial Lighting. Price, \$1.50.

Poultry House Construction. Price, \$2.00.

Profitable Culling. Price, \$2.00.

Successful Poultry Keeping. Price, \$1.00.

How to Feed Poultry for Any Purpose. \$1.25.

Artificial Incubating and Brooding. Price, \$1.00.

The Chick Book. Price, 50c.

Fundamentals of Poultry Breeding. Price, \$2.00.

Poultry for Exhibition. Price, \$2.00.

Ducks and Geese. Price, \$2.50.

High Egg Production. Price, \$2.00.

The Asiatics. Price, 50c.

Turkeys, 75c.

Baskets.

Special prices in lots of 1,000 on Peach, Strawberry and Pansy Baskets. As these are subject to market fluctuations, write for quotations.

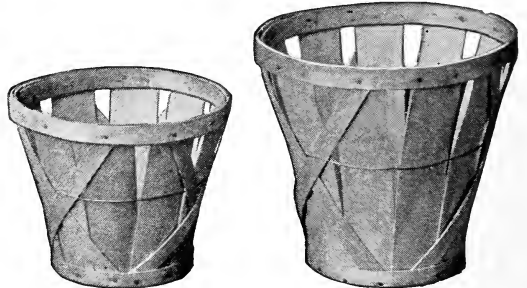

Strawberry Baskets, 20c. doz.; \$1.25 per 100.

Peach Baskets, 16-qt., \$2.00 per 25; \$7.00 per 100.

Pansy Baskets, 2-qt., 30c. per doz.; \$2.50 per 100.

Till Baskets, 3-qt., 35c. per doz.; \$2.50 per 100

4-qt., 40c. per doz.; \$3.00 per 100.

Diamond Market Baskets, 20c.

Special prices on large quantities.

Rustic Bird Houses and Food Shelters.



During the winter when the natural food supply is at its lowest birds are driven into close companionship with man. The friendship of the little chickadees, juncos, nuthatches, downy woodpeckers, blue jays and others may be won by small offerings of food. Bird seed, suet, meat scraps, bread, etc., are always welcome. Once the birds have found your feeding station they will come again and again. Their antics, their habits, and their songs will afford you endless entertainment.

Feeding stations will help many of the migrating birds and, since birds prefer to nest where there is an abundance of food, these feeders will also help to bring tenants to your bird-houses. Place bird houses and feeding stations about your home and enjoy the companionship of the wild feathered friends winter and summer. Several styles priced 85c. up. Circular upon request.

Platt's Wild Bird Food.

Platt's Wild Bird Seed is a special mixture of whole seeds, carefully field tested to determine their value as bird food. You should see the wild birds flock to the feeding stations where this is used. It is a favorite mixture for attracting rare and beautiful song birds to many gardens—especially attractive to:

- | | |
|-----------------------|----------------------|
| Purple Finch | White Breasted Nut |
| Red Poll | Hatch |
| Gold Finch | Chicadee |
| Pine Siskin | Blue Jay |
| Vesper Sparrow | Snow Bunting |
| White Crowned Sparrow | Lapland Song Sparrow |
| Junco | Tree Sparrow |
| Song Sparrow | Chipping Sparrow |
| Ruffed Grouse | Fox Sparrow |
| | Quail |

Put up in packages of 7 lbs., 50c.; 15 lbs., \$1.00; also 100 lb. bags. Postage extra.

Platt's Canary and Cage Bird Seed.



This mixture is made of the very best grade of re-cleaned Sicily Canary and German Rape proportioned according to years of observation and experience in feeding canaries. Price 15c. per 1 qt., package 25c.

Thistle Seed — Poppy Seed — Bird Sand — Cuttle Bone — Song Restorer — Regulator — Bird Tonic — Baths, Etc. See page 80.

Beekeepers' Supplies.

A COMPLETE CATALOGUE ON APPLICATION.

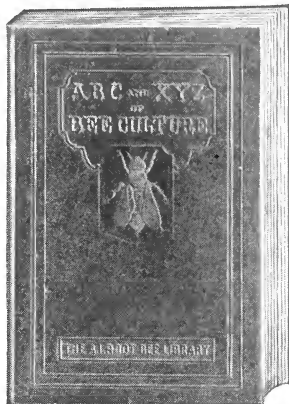

A. B. C. of Bee Culture.

Fabrikoid Cover, \$2.50

No other beekeeping authority has traveled so far and so thoroughly among American beekeepers as has E. R. Root, and he has done this solely to keep abreast of the beekeeping times. All that he has found best in the whole field of beekeeping he has put into this work.

Root Smokers.

Jumbo, 4-inch, \$1.25; postage by Parcel Post, 2 lbs., Standard, 3¼-inch, \$1.00; postage by Parcel Post, 2 lbs. Junior, 2½-inch, 75c.; postage by Parcel Post, 1½ lbs.

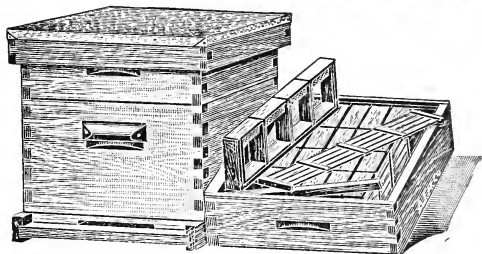
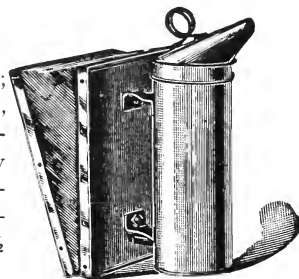

This is a cut of a modern bee hive with one super on and another alongside showing sections ready for bees to fill with honey.

Alexander Veils.

Price, 80c.



This is one of the most popular veils we sell. Made of black screen wire, it is more durable than cotton or silk veils, as it will not catch or tear on any obstruction. It is worn without hat and for this reason is very cool in summer. The top is made of muslin gathered at the center, and the bottom is of the same material made in the form of a skirt, which may be drawn snugly around the collar by means of a drawstring. Shipping weight, 1 lb.

SPRAY CALENDAR

and useful information

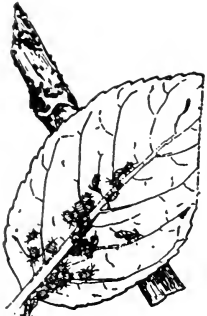

Aphids on Leaf.

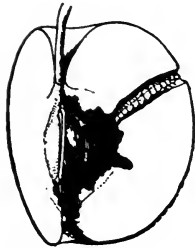

Codling Moth or
Apple Worm.



Canker Worm.



Tent Caterpillar.



Plum Curculio.

CABBAGE—CAULIFLOWER.

Cabbage Worm. Green worms feed upon leaves all through season. Spray unheaded plants with lead arsenate. Use Red Arrow.



Cabbage Worm.

Cabbage Lopper. Smooth looping caterpillars feed with cabbage worms late in summer, and require same treatment.

Cabbage Maggot. Infest stems of early-set plants near surface of ground, checking growth and often killing them. Practice crop rotation. Place hexagonal tarred paper discs around stems at setting

time. Treat with carbolic acid emulsion.

Club Root. Causes knob-like enlargements on the roots of cabbage and allied plants. The germ often becomes established in the soil; when possible avoid such land and the use of refuse from old plants on the soil. Be especially careful that the seed bed is not infested. Infested land, if used, should be treated in the fall with lime broadcast at the rate of 80 bushels per acre, and worked in.

CELERY.

Celery Caterpillar. Feeds upon the leaves of celery, parsley, fennel, carrot and parsnip. On the latter two plants, lead arsenate may be used. On celery and parsley use Red Arrow.

Leaf Blight and Leaf Spot are two diseases showing "rusty" spots on leaves and petioles; the latter trouble distinguished by the very minute black dots in the discolored spots, often progressing in stalks after storage. Spray the plants thoroughly in the seed bed with Bordeaux, as infected plants are often the means of introducing the trouble in the field. If necessary continue the spraying after transplanting at intervals of about two weeks, up to the middle of September. Before covering for bleaching, if leaf spot is abundant, dust with sulphur, and before final storage remove infected leaves and dust again.

CORN.

Corn Ear Worm. Eats the immature kernels at the end of the ear. Dust with equal parts sulphur and powdered lead arsenate.

CUCUMBERS.

Striped Cucumber Beetle. Attacks young plants, eating the leaves. Larvae infest the main root or stem under ground, often killing the plant.

CURRENT.

Current Worm. Devours foliage in May. Spray with hellebore or lead arsenate soon as leaves unfold.

Current Borers. The larvae of two species of insects tunnel in the pith of the stems, causing the leaves to droop and wilt. Destroy infested canes during May.

Current Aphids. Yellowish-green aphids on under side of leaves, causing them to curl. Under-spray with nicotine solution.

ELM.

Spiny Elm Caterpillar. Clusters of black spiny caterpillars often strip certain branches of elm, willow and poplar. Remove and destroy entire cluster, or spray with lead arsenate.

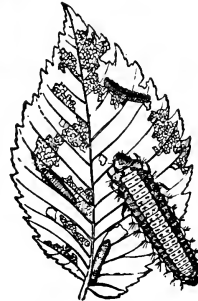

Larvae of Elm Leaf
Beetle.

Elm Leaf Beetle. Adult beetles eat holes through the leaves in May, and in June and July the larvae or grubs eat away the green tissues from the under surface. Spray with lead arsenate early in May to kill egg-laying beetles, or spray under surface of leaves with same mixture about June 1st, to kill the larvae. Yellow pupae at base of trees may be killed with oil.

GRAPE.

Grape Plume Moth. Small, green, shiny caterpillars web together the newly-formed leaves at the tips of new shoots. Damage more apparent than real. Crushing by pinching these leaves is the best remedy.

Grape Berry Moth. Larvae feeds and develops inside the berries, and this is the cause of most wormy grapes. Spray with lead arsenate soon after fruit sets, and repeat twice at intervals of about ten days. Bag the clusters soon after the fruit sets.

Sphinx and Other Caterpillars. Several species of horn worms, as well as other kinds of caterpillars, feed upon the leaves. Spray with lead arsenate or practice hand picking.

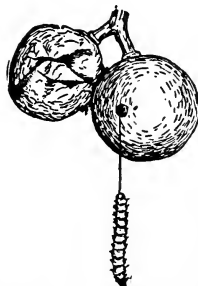

Grape Berry Moth.

Grape Leaf-Hopper. Small yellow and red marked leaf-Hoppers sucking sap from under side of leaves. Spray under surface with nicotine solution or Red Arrow.

Black Rot. Causes reddish-brown spots on leaves; more rarely on stems; especially bad in rotting the berries, which finally become hard, shrunken and wrinkled black mummies. This is one of the worst diseases of the grape, and often difficult to control by spraying, which must be thorough, especially the first season. Begin spraying before blossoming time, about the last of May, with second application just after blossoming and subsequent sprayings at intervals of about ten to fourteen days. Use Bordeaux up to the last of July, and then change to the soda Bordeaux, or Amm. Sol. Cop. Carbonate, though usually the four or five sprayings with Bordeaux are sufficient.

HOLLYHOCK.

Rust. Appears as small, compact, reddish-brown outbreaks on leaves and stems. After their death in fall, cut off the plants close to the ground, carefully gather up these and any rubbish that may contain spores and destroy them. Spraying with Bordeaux is recommended by some as helpful in checking the rust; begin as plants push through the ground.

MAPLE.

Maple Borer. Larva tunnels in spiral course upward around trunk or larger branches of sugar maple, working in sapwood and cambium, often girdling the trees. Examine trees in September for sawdust. Find the burrow, inject carbon disulphide and plug the opening.

Woolly Maple Leaf Scale. Cottony or woolly masses of wax, containing the females, eggs and sometimes larvae, appear on the under side of the leaves in midsummer; insects suck out the sap, causing leaves to fall prematurely. Males and larvae enter crevices of bark of trunk and branches; larvae make cases here and pass the winter. Attacks only sugar maples. Spray dormant trees with nicotine solution and soap. Burn all infested leaves.

Cottony Maple Scale. Large, oval, brown, soft scales on bark of branches of silver and red maples. Each scale in early summer develops a large cotton-like tuft of wax nearly half an inch long, and soon after the young appear. Spray with miscible oils when dormant.

MUSK MELON.

Melon Aphid. Sucks the sap from the under side of the leaves and, when abundant, causes much damage. Underspray the leaves with nicotine solution or Red Arrow.

Striped Cucumber Beetle. See Cucumber.

NASTURTIUM.

Aphid. Brown aphids cluster on stems and leaves, sucking the sap. Spray with nicotine solution or Red Arrow.

ONION.

Trips or "White Blast." Very small insects which feed upon the surface of the leaves, giving the field a whitish appearance. Burn all tops and refuse; burn over the grass land around the field to kill over-wintering insects. Spray with nicotine solution or Red Arrow.

PEA.

Green Pea Aphid. Attacks the plants early in June and sucks the sap from the leaves and stems,

often causing great injury. Early peas may mature a crop before aphid injures them. Spray vines with nicotine solution or Red Arrow.

POTATO.

Flea Beetle. Small black jumping beetles eat holes through the leaves. Spray heavily both upper and under surfaces with lead arsenate.

Colorado Beetle. Adults and larvae devour the leaves. Spray with lead arsenate as soon as injury apparent. May be used in Bordeaux mixture.

Three-Lined Potato Beetle. Larvae feed upon the leaves and carry their black excrement on their backs. Spray with lead arsenate.

Stalk Borer. Larvae tunnels inside the stalk. Burn infested vines.

Potato Aphid. Green aphids appearing in large numbers suck the sap from shoots and stems, causing much damage. Spray with nicotine solution or Red Arrow.

Blight or Downy Mildew.

Causes a sudden blackening of the leaves, and often death to the vines, from July to September, in moist seasons; usually shows a slight whitish growth of fungus on the under side of leaves; rots tubers. Spray with Bordeaux before the trouble appears about July 1st, and keep vines well covered to the end of the season. Three to five sprayings by hand to five to seven by power sprayer are necessary. After last cultivation thoroughly ridge up the rows to help keep the spores from washing down the tubers. Early varieties often escape blight by maturing before its appearance.

Scab. Produces the common scabby appearance on surface of tubers. Soak seed tubers one and one-half hours in formalin (formula B). Formalin fumes are often used when large quantities are treated. Care in filling space sufficiently, however, is necessary to avoid injury by "pitting" from absorption of fumes. Avoid planting on infected land by systematic rotation. The use of lime, wood ashes, and various barnyard manures will increase the amount of scab. The same trouble occurs on beets and turnips.

Semesan Bel also recommended.

ROSE.

Rose Slug. Eats away the green portions of the leaves. Spray with Red Arrow.

Aphid or Green Fly. Suck sap from the leaves and stems. Spray with nicotine solution or Red Arrow.

Mildew. Develops a white powdery or cobweb-like growth on the young leaves, which become more or less distorted and fall off. Tea roses especially susceptible. Treat same as for leaf blotch; or dust flowers of sulphur over the leaves; be careful in airing greenhouses.

SQUASH—PUMPKIN.

Squash Lady-Beetle. Both adults and larvae devour the leaves. Spray with lead arsenate or Red Arrow.

Striped Cucumber Beetle. See Cucumber.

Squash Bug or "Stink Bug." A brown bug three-fourths of an inch long sucks the sap from the under side of the leaves, causing them to wilt and die. Spray with Red Arrow.



Potato Beetle.

A Successful Fruit Spray Program

for those who wish to prepare small quantities. The following amounts are for 10 gallons of spray. Read manufacturers' directions for using greater or less strength. It is very important that the spray is applied at the right time, otherwise it is almost worthless. The illustrations below show the four most important stages or times to spray.

For Apple and Pear Trees.



Delayed Dormant

First: Delayed Dormant. To control Scale, Aphis, Pear Thrips, Leaf Roller, European Red Mite and Tent Caterpillar.

Scaleside (1-15). 2½ qts. Scaleside - 37½ qts. water makes 10 gallons of spray.

Second: Pre-Pink. For Scab control to make 10 gallons. 3 oz. Calcium Caseinate
2 oz. Red Arrow or Black Leaf 40
6½ oz. Sulfocide.



Pink or Pre-Blossom

Fourth: Calyx, or Codling Moth Spray to make 10 gallons.

5 oz. Calcium Caseinate
5 oz. Arsenate of Lead
6½ oz. Sulfocide.
2 oz. Red Arrow or Black Leaf 40



Pre-Pink

Third: Pink Spray for Scab control—Repeat **Second**.



Calyx Spray

Fifth: For Codling Moth and Late Scab Infection—Repeat **Fourth** Spray 14 days after.

Sixth: For Second Brood of Codling Moth and Leaf Diseases—Repeat **Fourth** Spray six weeks after **Fourth**.

For Peach, Plum, and Cherry Trees.

First: Dormant Spray.

Scaleside (1-15). 2½ qts. Scaleside with water to make 10 gallons.

Second: As the buds swell and before blossoms open.

3 oz., Calcium Caseinate
6½ oz. Sulfocide

Third: As the Shucks Fall from the Newly Formed Fruit.

3 oz. Calcium Caseinate
3 oz. Arsenate of Lead
6½ oz. Sulfocide

Fourth: Two weeks later for Brown Rot and Scab.

3 oz. Calcium Caseinate
6½ oz. Sulfocide

Fifth: Ten days to two weeks later Repeat **Fourth** Spray for Brown Rot and Scab.

Important Note. Mix in order given. Never put together in concentrated form.

INSECTICIDE MEASUREMENTS AND DILUTIONS

| | Normal dilution rate | to make 50 gals. | to make 10 gals. | to make 3 gals. |
|--------------------------|----------------------|------------------|------------------|------------------|
| Arsenate of Lead Powder | 1½ lbs. to 50 gals. | 1½ lbs. to 50 | 5 oz. | 1½ oz. |
| Bordeaux Mixture, 22% | 3½ lbs. to 50 gals. | 3½ lbs. | 11 oz. | 3½ oz. |
| Bordo-Lead | 4½ lbs. to 50 gals. | 4½ lbs. | 14 oz. | 4½ oz. |
| Calcium Caseinate | 3 lbs. to 200 gals. | ¾ lb. | 3 oz. | 1 oz. |
| Black Leaf 40 | 2 lbs. to 200 gals. | ½ lb. | 1½ oz. | 3 tsp. |
| Lime Sulphur, Winter | 1 to 8 | 6 gals. | 1¼ gals. | 3 pts. |
| Lime Sulphur, Summer | 1 to 40 | 1¼ gals. | 1 qt. | ½ pt. |
| Lime Sulphur, Dry-Summer | 3 lbs. | 3 lbs. | 10 oz. | 3 oz. |
| Red Arrow Insect Spray | 1 to 800 | ½ lb. | 1½ oz. | 3 tsp. |
| Scaleside | 1 to 15 | ¾ gals. | 2½ qts. | 3 cups (1½ pts.) |
| Sulfocide | 1 to 200 | 1 qt. | ¾ cup (6½ oz.) | 2 oz. |
| Volck | 1 to 100 | 2 qts. | 1½ cups (12 oz.) | 4 oz. |

4 teaspoonsful = 1 tablespoon
2 tablespoonsful = 1 fluid ounce

16 fluid ounces = 1 pint
8 pints = 1 gallon

VEGETABLE AND FIELD SEEDS

| PAGE | | PAGE | |
|------------------------|---------|---------------------------|------------|
| Anise..... | 37 | Clover Seeds..... | 42 |
| Artichoke..... | 7 | Collards..... | 15 |
| Asparagus Roots..... | 7 | Coriander..... | 37 |
| Asparagus Seed..... | 7 | Corn, Ensilage..... | 17 |
| Balm..... | 37 | Corn, Field..... | 17 |
| Barley..... | 39 | Corn, Popping..... | 17 |
| Beans, Bush..... | 5, 8, 9 | Corn, Sweet..... | 5, 16, 17 |
| Beans, Pole..... | 10 | Corn Salad..... | 18 |
| Beets..... | 10, 11 | Cow Peas..... | 38 |
| Borage..... | 37 | Cress or Peppergrass..... | 18 |
| Broccoli..... | 11 | Cress, Water..... | 18 |
| Broom Corn..... | 38 | Cucumber..... | 5, 18, 19 |
| Brussels Sprouts..... | 11 | Dandelion..... | 19 |
| Buckwheat..... | 39 | Dill..... | 37 |
| Cabbage..... | 12 | Egg Plant..... | 20 |
| Canada Field Peas..... | 38 | Endive..... | 20 |
| Caraway..... | 37 | Farm Seeds..... | 38, 39 |
| Cardoon..... | 13 | Fennel..... | 20, 37 |
| Carrots..... | 5, 13 | Flax..... | 38 |
| Catnip..... | 37 | Garlic Sets..... | 20 |
| Cauliflower..... | 4, 14 | Grains..... | 39 |
| Celery..... | 14 | Grass Seeds..... | 40, 41 |
| Celery..... | 4, 15 | Hemp..... | 38 |
| Chervil..... | 15 | Herbs..... | 37 |
| Chicory..... | 15 | Horehound..... | 37 |
| Chives..... | 15 | Kaffir Corn..... | 38 |
| Chufas..... | 15 | Kale..... | 21 |
| | | Kohl-Rabi..... | 21 |
| | | Lavender..... | 37, 55 |
| | | Lawn Grass Seed..... | 6, 40 |
| | | Leek..... | 21 |
| | | Lettuce..... | 22 |
| | | Mangel Wurtzel..... | 11 |
| | | Marrows..... | 34 |
| | | Martynia..... | 23 |
| | | Melon, Citron..... | 24 |
| | | Melon, Musk..... | 23 |
| | | Melon, Water..... | 24 |
| | | Merit List..... | 3-6 |
| | | Millets..... | 42 |
| | | Mushroom Spawn..... | 24 |
| | | Mustard..... | 24 |
| | | Oats..... | 39 |
| | | Okra..... | 26 |
| | | Onion..... | 25 |
| | | Onion Sets..... | 25 |
| | | Parsley..... | 26 |
| | | Parsnip..... | 26 |
| | | Peas..... | 27, 28, 38 |
| | | Peppers..... | 29 |
| | | Potatoes..... | 29, 30 |
| | | Pumpkin..... | 30 |
| | | Radish..... | 30, 31, 32 |
| | | Rape..... | 32 |
| | | Rhubarb..... | 32 |
| | | Rue..... | 37 |
| | | Ruta Bagas..... | 36 |
| | | Rye..... | 39 |
| | | Sage..... | 37 |
| | | Salsify..... | 32 |
| | | Soja Bean..... | 38 |
| | | Sorrel..... | 32 |
| | | Spinach..... | 6, 32, 33 |
| | | Squash..... | 4, 33, 34 |
| | | Sudan Grass..... | 38 |
| | | Sugar Cane..... | 38 |
| | | Summer Savory..... | 37 |
| | | Sunflower..... | 38 |
| | | Sweet Basil..... | 37 |
| | | Sweet Fennel..... | 37 |
| | | Sweet Marjoram..... | 37 |
| | | Swiss Chard..... | 11 |
| | | Thyme..... | 37 |
| | | Tobacco..... | 34 |
| | | Tomato..... | 34, 35 |
| | | Turnip..... | 36 |
| | | Vegetable Seeds..... | 4-37 |
| | | Vetches..... | 38 |
| | | Wheat..... | 39 |
| | | Witloof..... | 37 |
| | | Wormwood..... | 37 |

FLOWER SEEDS

| PAGE | | PAGE | |
|-------------------------|--------|-------------------------|-----------|
| Abronia..... | 43 | Celosia..... | 48 |
| Abutilon..... | 43 | Centaurea..... | 48, 49 |
| Achillea..... | 43 | Chrysanthemum..... | 49 |
| Acroclinium..... | 43 | Cineraria..... | 49 |
| Ageratum..... | 43 | Clarkia..... | 49 |
| Agrostemma..... | 43 | Cleome..... | 49 |
| Alyssum, Sweet..... | 43 | Clianthus..... | 49 |
| Amaranthus..... | 43 | Cobaea..... | 49 |
| Ampelopsis..... | 44 | Cockscomb..... | 48 |
| Anchusa..... | 44 | Coleus..... | 49 |
| Antirrhinum..... | 44 | Columbine..... | 44 |
| Aquilegia..... | 44 | Convolvulus..... | 50 |
| Aristolochia..... | 44 | Coreopsis..... | 46, 50 |
| Asparagus..... | 44 | Cornflower..... | 48 |
| Asperula..... | 44 | Cosmos..... | 50 |
| Aster..... | 44, 45 | Cucumis..... | 50 |
| Auricula..... | 62 | Cyclamen..... | 50 |
| Balloon Vine..... | 45 | Cynoglossum..... | 50 |
| Balsam..... | 45 | Cypress Vine..... | 50 |
| Balsam, Apple..... | 57 | Dahlia..... | 50 |
| Bartonia..... | 45 | Daisy..... | 46, 51 |
| Begonia..... | 46 | Datura..... | 51 |
| Bellis Perennis..... | 46 | Delphinium..... | 51, 55 |
| Brachycome..... | 46 | Dianthus..... | 51 |
| Briza Maxima..... | 53 | Didiscus..... | 51 |
| Browallia..... | 46 | Digitalis..... | 51 |
| Cacalia..... | 46 | Dimorphotheca..... | 51 |
| Calandrinia..... | 46 | Dracaena..... | 52 |
| Calceolaria..... | 46 | Dusty Miller..... | 49 |
| Calendula..... | 47 | Edelweiss..... | 52 |
| Calliopsis..... | 46 | Eschscholtzia..... | 52 |
| Campanula..... | 47 | Euphorbia..... | 52 |
| Canary Bird Flower..... | 47 | Everlastings..... | 53, 62 |
| Candytuft..... | 47 | Feverfew..... | 52 |
| Canna..... | 47 | Flower Seeds..... | 3, 43, 67 |
| Canterbury Bells..... | 48 | Forget-me-not..... | 57 |
| Cardinal Climber..... | 55 | Gaillardia..... | 52 |
| Carnation..... | 48 | Geranium..... | 53 |
| Castor Oil Beans..... | 62 | Gilia..... | 53 |
| | | Globe Amaranth..... | 53 |
| | | Godetia..... | 53 |
| | | Gourds..... | 53 |
| | | Grasses..... | 53 |
| | | Gypsophila..... | 53 |
| | | Helianthus..... | 54 |
| | | Helichrysum..... | 53 |
| | | Heliotrope..... | 54 |
| | | Hibiscus..... | 54 |
| | | Hollyhock..... | 54 |
| | | Honesty..... | 54 |
| | | Humulus..... | 54 |
| | | Hyacinth Bean..... | 54 |
| | | Ice Plant..... | 54 |
| | | Impatiens..... | 54 |
| | | Ipomea..... | 55 |
| | | Kenilworth Ivy..... | 55 |
| | | Kochia..... | 55 |
| | | Kudzu Vine..... | 55 |
| | | Lantana..... | 55 |
| | | Larkspur..... | 3, 51, 55 |
| | | Lathyrus..... | 55 |
| | | Lavender..... | 37, 55 |
| | | Linum..... | 56 |
| | | Lobelia..... | 56 |
| | | Lupinus..... | 56 |
| | | Lychnis..... | 56 |
| | | Marigold..... | 3, 47, 56 |
| | | Maurandia..... | 56 |
| | | Marvel of Peru..... | 56 |
| | | Mignonnette..... | 57 |
| | | Mimosa..... | 57 |
| | | Mimulus..... | 57 |
| | | Mina Lobata..... | 57 |
| | | Moon Flower..... | 55 |
| | | Mormordica..... | 57 |
| | | Morning Glory..... | 50, 55 |
| | | Myosotis..... | 57 |
| | | Myrsiphyllum..... | 63 |
| | | Nasturtium..... | 58 |
| | | Nemophila..... | 57 |
| | | Nicotiana..... | 57 |
| | | Nigella..... | 57 |
| | | Pansy..... | 59 |
| | | Passiflora..... | 59 |
| | | Pentstemon..... | 59 |
| | | Petunia..... | 60 |
| | | Phlox..... | 60 |
| | | Physalis Francheti..... | 61 |
| | | Polyanthus..... | 61 |
| | | Poppy..... | 60, 61 |
| | | Portulaca..... | 61 |
| | | Primrose..... | 61 |
| | | Primula..... | 61 |
| | | Pyrethrum..... | 62 |
| | | Rhodanthe..... | 62 |
| | | Ricinus..... | 62 |
| | | Rudbeckia..... | 62 |
| | | Salpiglossis..... | 62 |
| | | Salvia..... | 62 |
| | | Scabiosa..... | 62 |
| | | Schizanthus..... | 63 |
| | | Silene..... | 63 |
| | | Smilax..... | 63 |
| | | Solanum..... | 63 |
| | | Stevia..... | 63 |
| | | Stocks..... | 63 |
| | | Stokesia..... | 63 |
| | | Sunflower..... | 54 |
| | | Sweet Peas..... | 64, 65 |
| | | Sweet Sultan..... | 48 |
| | | Sweet William..... | 65 |
| | | Thunbergia..... | 65 |
| | | Valerian..... | 65 |
| | | Verbena..... | 65 |
| | | Vinca..... | 65 |
| | | Wall Flower..... | 65 |
| | | Wild Flower Garden..... | 65 |
| | | Zinnia..... | 66 |

MISCELLANEOUS

| Bulbs | | | | | |
|----------------------------|----|----------------------|----------------|-------------------------|-------------|
| Caladium | 67 | Dog Food | 90 | Lawn Guards | 80 |
| Cinnamon Vine | 67 | Dusting Guns | 75 | Lawn Mowers | Cover 2, 73 |
| Gladiolus | 67 | Fern Pans | 79 | Lime | 70 |
| Tuberose | 67 | Fertilizers | 70, 71 | Mastica | 78 |
| Madeira Vine | 67 | Fruit Pickers | 77 | Mole Traps | 77 |
| Vegetable Plants and Roots | 68 | Fumigators | 69 | Mulch Paper | 80 |
| | | Fungicides | 68, 69, 70 | Nozzles | 74 |
| | | Garden Line | 78 | Pans | 79 |
| | | Garden Reel | 78 | Peat Moss | 71, 80 |
| | | Glazier's Points | 78 | Planet Jr., Implements | 72 |
| | | Grafting Blade | 75 | Plant Boxes | 79 |
| | | Grafting Wax | 75 | Plant Stakes | 77 |
| | | Grass Catchers | 80 | Pots | 79 |
| | | Hedge Trimmers | 75 | Poultry Supplies | 81-90 |
| | | Hoes | 76, 77 | Powder Guns | 75 |
| | | Hose | 76 | Presses, Cider and Wine | 73 |
| | | Hose Reels | 76 | Pruning Saw | 75 |
| | | Hot Bed Mats | 78 | Pumps | 74 |
| | | Hot Bed Sash | 78 | Putty Bulb | 78 |
| | | Hotkaps | 79 | Raffia | 78 |
| | | Inoculating Cultures | 37 | Rakes | 72, 76 |
| | | Insecticides | 68, 69, 70, 71 | Rollers | 80 |
| | | Knives | 75, 77 | Root Cutter | 88 |
| | | Labels | 77 | Rubber Hose | 75 |
| | | | | Salt, Agricultural | 70 |
| | | | | Salt, Cattle | 88 |
| | | | | Saucers | 79 |
| | | | | Seed Drill | 72 |
| | | | | Seed Sower | 72 |
| | | | | Shears | 75 |
| | | | | Shovels | 76 |
| | | | | Shuffle Hoe | 77 |
| | | | | Sowers | 72 |
| | | | | Spades | 76 |
| | | | | Spading Forks | 76 |
| | | | | Sprayers | 74, 75 |
| | | | | Spray Materials | 68, 69 |
| | | | | Sprinklers | 76, 77 |
| | | | | Thermometers | 78, 82 |
| | | | | Tree Labels | 77 |
| | | | | Tree Pruners | 75 |
| | | | | Tree Tubs | 79 |
| | | | | Trowels | 77 |
| | | | | Turf Edgers | 76 |
| | | | | Tying Materials | 78 |
| | | | | Watering pots | 78 |
| | | | | Weeders | 77 |
| | | | | Weed Killer | 70 |

POULTRY SUPPLY DEPARTMENT

| Alfalfa, Mealed | 83 | Dog Bread, Puppy Biscuits, | 90 | Lamps and Burners | 82 |
|---------------------------|--------|------------------------------|--------|--------------------------------|--------|
| Baskets | 90 | Soap—Flea Powder | 90 | Leg Bands | 87 |
| Beef or Meat Scrap | 83 | Egg Boxes and Carriers | 86 | Lice Killers and Powders | 89, 90 |
| Beekeepers' Supplies | 91 | Egg Candles | 82 | Lime for Whitewashing | 90 |
| B-K | 89 | Egg Grading Scales | 82 | Milking Tubes | 87 |
| Bone, Granulated or Flour | 83 | Egg Preservatives | 86 | Nest Eggs, China or Napthalene | 87 |
| Books on Bees | 91 | Feed Boxes, Pans and Holders | 84, 85 | Nests, Wire and Metal | 87 |
| Books on Poultry | 90 | Feeds | 83 | Oat and Grain Sprouters | 85 |
| Brooders and Parts | 81, 82 | Fish Scrap | 83 | Platt's Poultry Feed | 83 |
| Burners, Gas or Oil | 82 | Fly Spray | 90 | Parcel Post Egg Boxes | 86 |
| Carbola | 90 | Fountains | 84, 85 | Pigeon Baths and Nests | 87 |
| Caponizing Sets | 86 | Glass Cloth | 86 | Pilling's Poultry Killer | 87 |
| Cel-O-Glass | 86 | Grit | 83 | Poultry Markers, also Pigeon | 87 |
| Charcoal | 83 | Heaters | 82, 85 | Poultry Netting | 87 |
| Chicks, day-old | 81 | Hovers | 81, 82 | Powder Guns | 87 |
| Chick Shipping Boxes | 86 | Incubators and Supplies | 81-82 | Punches | 87 |
| Cod Liver Oil | 83 | Killing Knives | 87 | | |
| Disinfectants | 89, 90 | | | | |
| | | | | Rat Exterminators | 88 |
| | | | | Remedies, all kinds | 88, 89 |
| | | | | Roofing | 87 |
| | | | | Root Cutters | 88 |
| | | | | Root Smokers | 91 |
| | | | | Roup Cure and Pills | 88, 89 |
| | | | | Salt Cakes | 88 |
| | | | | Shells, Oyster | 83 |
| | | | | Shipping Coops and Crates | 82 |
| | | | | Sprayers | 74, 75 |
| | | | | Sulphur Candles | 89 |
| | | | | Thermometers | 78, 82 |
| | | | | Tobacco Dust | 88 |
| | | | | Toe Markers | 87 |
| | | | | Veils (Bee) | 91 |
| | | | | Water Glass | 86 |
| | | | | Wire Nests and Netting | 87 |
| | | | | Y-O, Conkey's | 83 |

Ask for Our Fall Bulb List of Spring Flowering Bulbs

The stately Darwin Tulips, the early Single and Double flowering Tulips, Hyacinths, Narcissus, Snowdrops, Crocus and others that announce spring and cheer the garden at a most welcome time. These bulbs should be purchased and set during the fall months. They are easily sent by parcel post.

We will pay the postage on bulb orders of \$1.00 or over to any address within 300 miles of New Haven.

If interested ask for our fall bulb list. It will be ready and sent free about September 10th.

| | <i>Seeds or Plants Required for 100 Feet of Row</i> | <i>Depth of Planting.</i> |
|------------------------|---|-------------------------------|
| Asparagus, seed..... | 1 ounce | 1 to 2 in. |
| Asparagus, plants..... | 60 to 80 plants | 3 to 5 in. |
| Beans, bush..... | 1 pint | 1 to 2 in. |
| Beans, pole..... | 1/2 pint | 1 to 2 in. |
| Beets..... | 1 ounce | 1 in. |
| Brussels Sprouts..... | 1/4 ounce | 1/2 in. |
| Cabbage, early..... | 1/4 ounce | 1/2 in. |
| Cabbage, late..... | 1/4 ounce | 1/2 in. |
| Carrot..... | 1/2 ounce | 1/2 in. |
| Cauliflower..... | 1/4 ounce | 1/2 in. |
| Celery..... | 1/4 ounce | 1/8 in. |
| Celery..... | 1/4 ounce | 1/8 in. |
| Chicory..... | 1/4 ounce | 1/2 in. |
| Citron..... | 1 ounce | 1 to 2 in. |
| Collards..... | 1/4 ounce | 1/2 in. |
| Corn Salad..... | 2 ounces | 1/2 to 1 in. |
| Corn, sweet..... | 1/4 pint | 1 to 2 in. |
| Cress, upland..... | 1/2 ounce | 1/2 to 1 in. |
| Cucumber..... | 1/2 ounce | 1 in. |
| Dandelion..... | 1/4 ounce | 1/2 in. |
| Egg Plant..... | 1/3 ounce | 1/2 in. |
| Endive..... | 1 ounce | 1/2 in. |
| Horse Radish..... | 70 roots | 3 to 4 in. |
| Kale or Borecole..... | 1/4 ounce | 1/2 in. |
| Kohl-Rabi..... | 1/4 ounce | 1/2 in. |

| | <i>Seeds or Plants Required for 100 Feet of Row</i> | <i>Depth of Planting.</i> |
|------------------------|---|-------------------------------|
| Leek..... | 1/2 ounce | 1 in. |
| Lettuce..... | 1/2 ounce | 1/2 in. |
| Melon, musk melon.... | 1/2 ounce | 1 in. |
| Melon, water melon.... | 1 ounce | 1 to 2 in. |
| Mustard..... | 1/4 ounce | 1/4 in. |
| New Zealand Spinach.. | 1 ounce | 1 to 2 in. |
| Okra, or Gumbo..... | 2 ounces | 1 to 2 in. |
| Onion, seed..... | 1 ounce | 1/2 to 1 in. |
| Onion, sets..... | 1 qt. of sets | 1 to 2 in. |
| Parsley..... | 1/4 ounce | 1/8 in. |
| Parsnip..... | 1/2 ounce | 1/2 to 1 in. |
| Peas..... | 1 to 2 pints | 2 to 3 in. |
| Pepper..... | 1/8 ounce | 1/2 in. |
| Potato, Irish..... | 5 lbs. | 4 in. |
| Potato, sweet..... | 75 slips | 3 in. |
| Pumpkin..... | 1/2 ounce | 1 to 2 in. |
| Radish..... | 1 ounce | 1/2 to 1 in. |
| Rhubarb, seed..... | 1/2 ounce | 1/2 to 1 in. |
| Ruta Baga..... | 1/4 ounce | 1/2 to 1 in. |
| Salsify..... | 1 ounce | 1/2 to 1 in. |
| Spinach..... | 1 ounce | 1 in. |
| Squash, bush..... | 1/2 ounce | 1 to 2 in. |
| Tomato..... | 1/8 ounce | 1/2 to 1 in. |
| Turnip..... | 1/2 ounce | 1/4 to 1/2 in. |

A Table Showing the Number of Pounds per Bushel, Quantity Usually Sown per Acre.

| | <i>Lbs. per bushel.</i> | <i>Quantity usually sown per acre.</i> |
|---|-----------------------------|--|
| Barley, broadcast..... | 48 | 2 to 3 bush. |
| Beans, dwarf, in hills..... | 60 | 1 1/2 bush. |
| Beans, pole, in hills..... | 60 | 10 to 12 qts. |
| Beans, Soja, in drills..... | 60 | 1/2 bush. |
| Beets, in drills..... | | 5 to 6 lbs. |
| Beets, in drills, Mangel Wurtzel. | | 4 to 5 lbs. |
| Broom Corn, in hills..... | 32 | 2 to 5 lbs. |
| Buckwheat..... | 48 | 1 bush. |
| Cabbage, in beds, to transplant . | 50 | 1/4-lb. |
| Carrots, in drills..... | | 3 to 4 lbs. |
| Clover, red..... | 60 | 15 to 20 lbs. |
| Clover, white..... | 60 | 12 to 15 lbs. |
| Clover, Alsike..... | 60 | 10 lbs. |
| Clover, Lucerne or Alfalfa..... | 60 | 20 lbs. |
| Corn, in hills..... | 56 | 8 to 12 qts. |
| Corn, for soiling..... | 56 | 3 to 4 bush. |
| Cucumber, in hills..... | | 2 lbs. |
| Flax, broadcast..... | 56 | 1 bush. |
| Grass, Kentucky Blue..... | 14 | 2 bush. |
| Grass, Kentucky Blue Fancy..... | 25 | 3/4 to 1 bush. |
| Grass, Orchard..... | 14 | 3 bush. |
| Grass, English Rye..... | 20 | 2 bush. |
| Grass, Sweet Vernal..... | 12 | 1 1/2 bush. |
| Grass, Red Top, Chaff..... | 14 | 1 to 2 bush. |
| Grass, Red Top, Recleaned Fancy..... | 35 | 1/2 to 3/4 bush. |
| Grass, Rhode Island Bent..... | 12 | 1 to 2 bush. |
| Grass, Timothy or Herd's Grass..... | 45 | 1/2 bush. |
| Grass, Hungarian..... | 48 | 1/2 to 3/4 bush. |
| Grass, Mixed Lawn..... | 18-25 | 3 to 4 bush. |
| Hemp..... | 40 | 1 1/2 bush. |
| Kale..... | 50 | 5 lbs. |
| Mustard, broadcast..... | 50 | 1/2 bush. |
| Melon, Musk, in hills..... | | 2 to 3 lbs. |

| | <i>Lbs. per bushel.</i> | <i>Quantity usually sown per acre</i> |
|-----------------------------------|-----------------------------|---|
| Melon, Water, in hills..... | | 3 to 4 lbs. |
| Millet, broadcast..... | 48 | 1/2 to 3/4 bush. |
| Millet, Japanese..... | 32 | 20 lbs. |
| Oats, broadcast..... | 32 | 2 1/2 to 3 bush. |
| Onion, in drills..... | | 5 to 6 lbs. |
| Onion, for sets, in drills..... | | 30 lbs. |
| Onion Sets, in drills..... | | 8 to 12 bush. |
| Parsnip, in drills..... | | 4 to 6 lbs. |
| Peas, Green Wrinkled..... | 56 | 1 1/4 to 1 1/2 bush. |
| Peas, Cow..... | 60 | 2 bush. |
| Peas, Round hard, in drills..... | 60 | 1 1/2 bush. |
| Peas, broadcast..... | 60 | 13 bush. |
| Potatoes, cut tubers..... | 60 | 9 to 12 bush. |
| Pumpkin, in hills..... | | 4 to 6 lbs. |
| Radish, in drills..... | | 8 to 10 lbs. |
| Rape, Dwarf Essex..... | 50 | 5 to 10 lbs. |
| Rye, Spring, broadcast..... | 56 | 1 1/2 to 2 bush. |
| Rye, Fall, broadcast..... | 56 | 1 1/2 to 2 bush. |
| Sage, in drills..... | | 5 to 8 lbs. |
| Salsify, in drills..... | | 8 to 10 lbs. |
| Spelt, Emmer..... | 40 | 1 1/2 to 2 bush. |
| Spinach, in drills..... | | 10 to 15 lbs. |
| Squash (bush varieties), in hills | | 4 to 6 lbs. |
| Squash (running varieties)..... | | 3 to 4 lbs. |
| Sudan Grass, in drills..... | | 20 lbs. |
| Sudan Grass, broadcast..... | | 6 to 8 lbs. |
| Sugar Cane..... | | 2 to 5 lbs. |
| Tomato, to transplant..... | | 1/4-lb. |
| Turnip, in drills..... | 50 | 1 1/2 to 2 lbs. |
| Turnip, broadcast..... | 50 | 3/4 to 1 1/2 lbs. |
| Wheat, Spring..... | 60 | 2 bush. |
| Wheat, broadcast, Winter..... | 60 | 2 bush. |
| Vetch, Spring..... | 60 | 2 bush. |
| Vetch, Winter..... | 60 | 1 bush. |

The Number of Plants, Trees, etc., Required to Set an Acre.

| <i>Distance</i> | <i>Number.</i> | <i>Distance.</i> | <i>Number.</i> | <i>Distance.</i> | <i>Number.</i> |
|----------------------------|----------------|----------------------|----------------|----------------------|----------------|
| 1 ft. by 1 ft..... | 43,560 | 3 ft. by 3 ft..... | 4,840 | 15 ft. by 15 ft..... | 194 |
| 1 1/2 ft. by 1 1/2 ft..... | 19,360 | 4 ft. by 4 ft..... | 2,722 | 18 ft. by 18 ft..... | 134 |
| 2 ft. by 2 ft..... | 10,890 | 5 ft. by 5 ft..... | 1,742 | 20 ft. by 20 ft..... | 105 |
| 2 1/2 ft. by 2 1/2 ft..... | 6,970 | 6 ft. by 6 ft..... | 1,210 | 25 ft. by 25 ft..... | 70 |
| 3 ft. by 1 ft..... | 14,520 | 9 ft. by 9 ft..... | 537 | 30 ft. by 30 ft..... | 40 |
| 3 ft. by 2 ft..... | 7,260 | 12 ft. by 12 ft..... | 302 | 40 ft. by 40 ft..... | 27 |

DELPHINIUM HYBRIDS

PLATT'S SPECIAL

A magnificent collection containing all the most beautiful shades of color in this type including the famous Wexham and Vanderbilt strains.

| | | |
|---------------|-----------------------|----------------|
| Light Blue | } Any Pkt. ea. 25c | |
| Deep Blue | | |
| Mid-Blue | | |
| Pastel Shades | | 1/4 oz. \$1.00 |
| All Shades | | 1 " \$3.75 |



GALLOWAY LITHO. CO. S.F. NO 103
MADE IN U.S.A.



THE FRANK S. PLATT CO.
SEEDSMEN • • • NEW HAVEN • CONN.